

REV CT

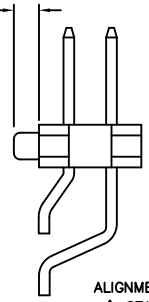
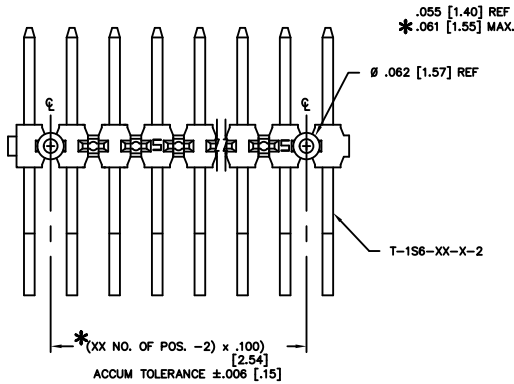

FIG 2

-A: ALIGNMENT PIN
ALIGNMENT PINS APPEAR ON -A OPTION ONLY.
* STAKED: USE (2) SM-A10H AND TSM-50-DHU
(CAN BE CUT TO POSITION)
NOT STAKED: USE TSM-XX-DHU-XX
(CAN BE CUT TO POSITION)
(DIFFERENT AS SHOWN, OTHERWISE
SAME AS FIG 1)

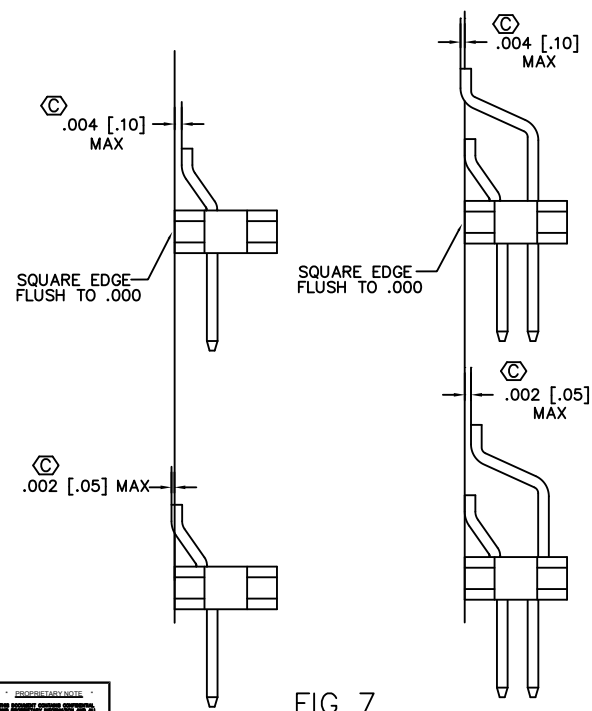

FIG 7
-DH SURFACEMOUNT DIAGRAM
IN PROCESS 3

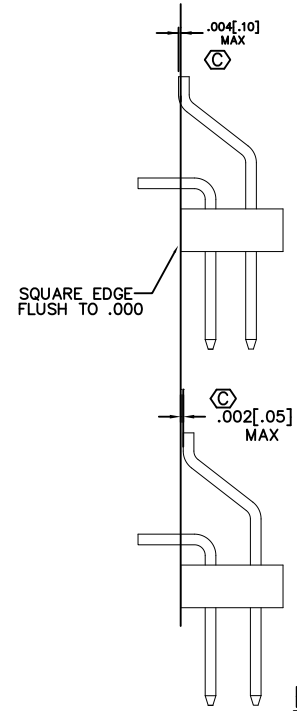
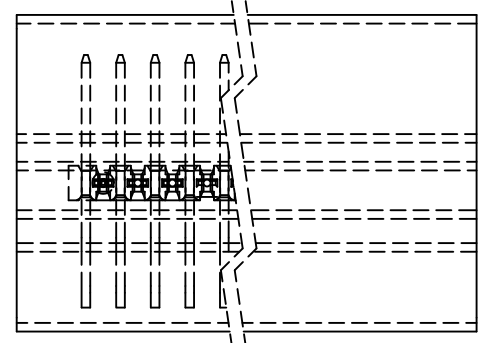
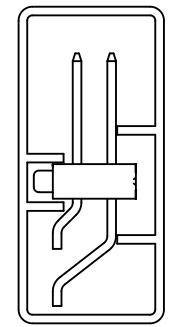

FIG 8
-MT SURFACEMOUNT DIAGRAM
IN PROCESS 4

DIMENSIONS ARE IN INCHES		UNLESS OTHERWISE NOTED		TOLERANCES ARE		TITLE:		DWG NO:
ONE PLACE DECIMALS ± .1 [3]	TWO PLACE DECIMALS ± .01 [3]	THREE PLACE DECIMALS ± .005 [13]	FOUR PLACE DECIMALS ± .0020 [65]	ANGLES	± 2°	TERMINAL STRIP DOUBLE SURFACE MOUNT		TSM-1XX-XX-XXX-XX-XX-XXX-XX
								SHEET 3 OF 3

PACKAGE AS SHOWN
SCALE .75



TUBE: PT-TSM001-DH
PLUG: TP-09

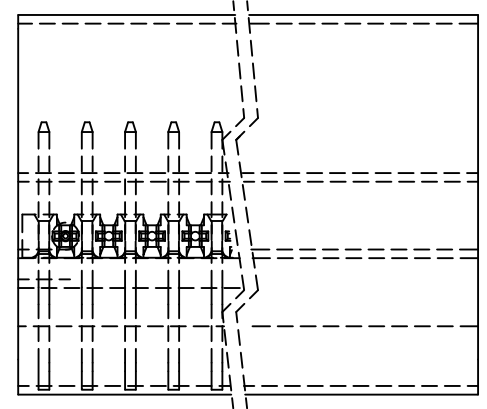
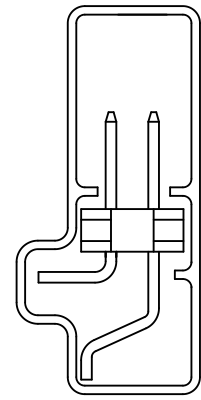

-MT OPTION
TUBE: PT-TSM005-DH-MT
PLUG: TP-07



EXISPROD\ASSEMBLY\100
TSM013

samtec

520 PARK EAST BLVD. NEW ALBANY, INDIANA 47150
PHONE (812) 944-8733 P.O. BOX 1147
CODE 95322

MADE BY: BRATCHER 7-27-95

TSM-1XX-XX-XXX-XX-XX-XXX-XX
SHEET 3 OF 3