

Description

The AP1682E is a high performance AC/DC universal input Primary Side Regulation Power Factor Controller for LED driver applications. The device uses Pulse Frequency Modulation (PFM) technology to regulate output current while achieving high power factor and low THD.

The AP1682E provides accurate constant current (CC) regulation while removing the opto-coupler and secondary control circuitry. It also eliminates the need of loop compensation circuitry while maintaining stability. The AP1682E achieves excellent regulation and high efficiency, yet meets the requirement of IEC61000-3-2 harmonic standard.

The AP1682E features low start-up current, low operation current and high efficiency. It also has rich protection features including over voltage, short circuit, over current protection etc.

The AP1682E is available in SO-8 package.

Features

- Primary Side Control for Output Current Regulation Without Opto-coupler and Secondary CV/CC Control Circuitry
- Low Start-up Current
- High Power Factor and Low THD for Universal Input Range
- Tight CC Regulation Performance for Universal Input Mains Voltage Range
- Eliminates Control Loop Compensation Circuitry
- Built-in Acceleration Start
- Open-load and Reload Detection
- Over Voltage and Short Circuit Protection
- Over Current Protection
- Cost Effective Total PFC LED Driver Solution
- **Totally Lead-Free & Fully RoHS Compliant (Notes 1 & 2)**
- **Halogen and Antimony Free. "Green" Device (Note 3)**
- **For automotive applications requiring specific change control (i.e. parts qualified to AEC-Q100/101/200, PPAP capable, and manufactured in IATF 16949 certified facilities), please [contact us](#) or your local Diodes representative. <https://www.diodes.com/quality/product-definitions/>**

- Notes:
1. No purposely added lead. Fully EU Directive 2002/95/EC (RoHS), 2011/65/EU (RoHS 2) & 2015/863/EU (RoHS 3) compliant.
 2. See <https://www.diodes.com/quality/lead-free/> for more information about Diodes Incorporated's definitions of Halogen- and Antimony-free, "Green" and Lead-free.
 3. Halogen- and Antimony-free "Green" products are defined as those which contain <900ppm bromine, <900ppm chlorine (<1500ppm total Br + Cl) and <1000ppm antimony compounds.

Pin Assignments

(Top View)

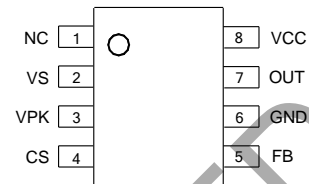

SO-8

Applications

- Single Stage Power Factor Correction Power Supply for LED Lighting

Absolute Maximum Ratings (Note 4)

Symbol	Parameter	Rating	Unit
V _{CC}	Power Supply Voltage	-0.3 to +35	V
I _{OUT}	Driver Output Current	300	mA
V _{VS} , V _{PK} , V _{CS}	Voltage at VS, VPK, CS	-0.3 to 7	V
V _{FB}	FB Input Voltage	-40 to 10	V
T _J	Operating Junction Temperature	+150	°C
T _{STG}	Storage Temperature	-65 to +150	°C
T _{LEAD}	Lead Temperature (Soldering, 10s)	+300	°C
P _D	Power Dissipation (T _A = +50°C)	0.65	W
θ _{JA}	Thermal Resistance (Junction to Ambient)	190	°C/W
—	ESD (Machine Model)	200	V
—	ESD (Human Body Model)	3000	V

Note 4: Stresses greater than those listed under “Absolute Maximum Ratings” can cause permanent damage to the device. These are stress ratings only, and functional operation of the device at these or any other conditions beyond those indicated under “Recommended Operating Conditions” is not implied. Exposure to “Absolute Maximum Ratings” for extended periods can affect device reliability.

Recommended Operating Conditions

Symbol	Parameter	Min	Max	Unit
V _{CC}	Power Supply Voltage	9	21	V
T _A	Ambient Temperature	-40	+105	°C

Electrical Characteristics (@ $V_{CC} = 15V$, $T_A = +25^{\circ}C$, unless otherwise specified.)

Symbol	Parameter	Conditions	Min	Typ	Max	Unit
UVLO Section						
$V_{TH} (ST)$	Start-up Threshold	—	18	19	20	V
$V_{OPR} (Min)$	Minimal Operating Voltage	After turn on	7.5	8	8.5	V
V_{CC_OVP}	VCC OVP Voltage	—	28	32	34	V
Standby Current Section						
I_{ST}	Start-up Current	$V_{CC} = V_{TH} (ST) - 0.5V$, Before start up	—	—	20	μA
$I_{CC} (Max)$	Maximum Operating Current	$V_{VS} = V_{PK} = 3V$	—	1000	1300	μA
Drive Output Section						
V_{OH}	Output High Level Voltage	$I_{GD-SOURCE} = 20mA$ $V_{CC} = 12V$	10	—	—	V
V_{OL}	Output Low Level Voltage	$I_{GD-SINK} = 20mA$ $V_{CC} = 12V$	—	—	1	V
t_R	Output Voltage Rise Time	$C_L = 1nF$	100	140	190	ns
t_F	Output Voltage Fall Time	$C_L = 1nF$	30	60	90	ns
$V_{O-CLAMP}$	Output Clamp Voltage	$I_{GD-SOURCE} = 5mA$ $V_{CC} = 20V$	12	13.5	15	V
V_{UVLO}	UVLO Saturation Voltage	$V_{CC} = 0$ to V_{CC-ON} $I_{SINK} = 10mA$	—	—	1.1	V
VS Input Section						
$V_{VS}/V_{PK} (Max)$	Maximum Ratio	$V_{VS} = V_{PK} = 3V$	0.8	1	1.2	V
$V_{VS}/V_{PK} (Min)$	Minimum Ratio	$V_{VS} = 0V$, $V_{PK} = 3V$	—	—	0.2	V
Current Sense Section						
$t_{ON} (Min)$	Minimum On Time	—	500	750	1000	ns
V_{SOCP}	Short Circuit Protection Voltage	—	3	4	—	V
Feedback Input Section						
I_{FB}	FB Pin Input Leakage Current	$V_{FB} = 4V$	—	2	8	μA
$V_{FB} (ACC)$	Acceleration Start Threshold	—	1.4	1.8	2.2	V
$V_{FB} (CV)$	CV Threshold	—	3.8	4.1	4.4	V
$V_{FB} (OVP)$	Over Voltage Protection	—	5.6	6.25	6.9	V
Over Temperature Protection Section						
—	Shutdown Temperature	—	—	+140	—	$^{\circ}C$
—	Temperature Hysteresis	—	—	+20	—	$^{\circ}C$

Performance Characteristics

Supply Current vs. Supply Voltage

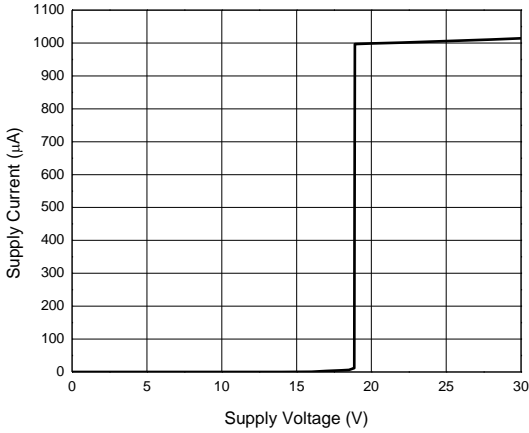

CV Threshold vs. Supply Voltage

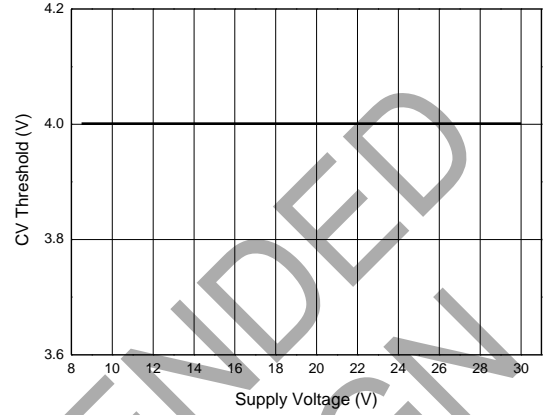

Output Clamp Voltage vs. Supply Voltage

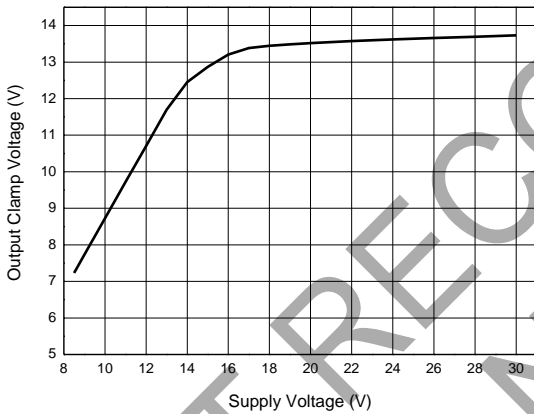

Start-up Voltage vs. Ambient Temperature

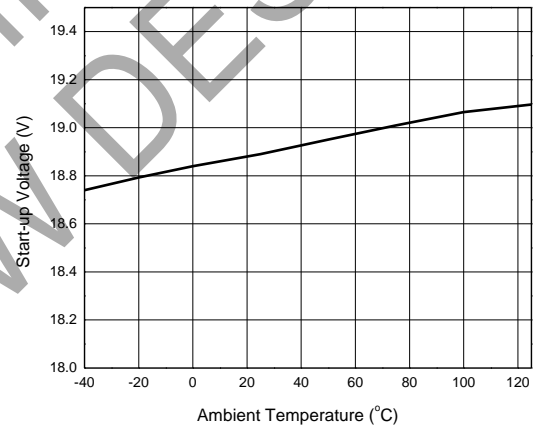

Minimal Operating Voltage vs. Ambient Temperature

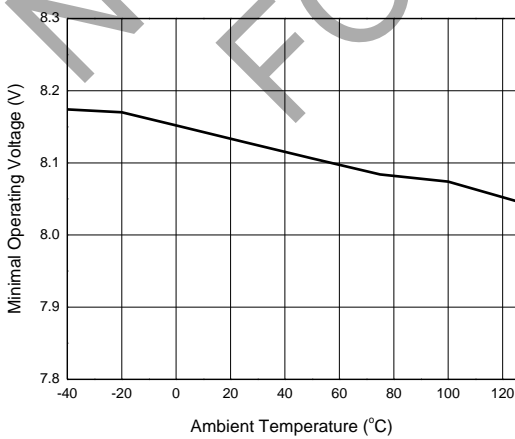

Start-up Current vs. Ambient Temperature

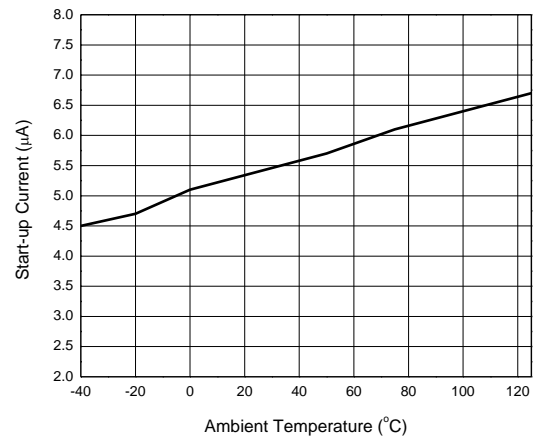

Performance Characteristics (continued)

Operating Current vs. Ambient Temperature

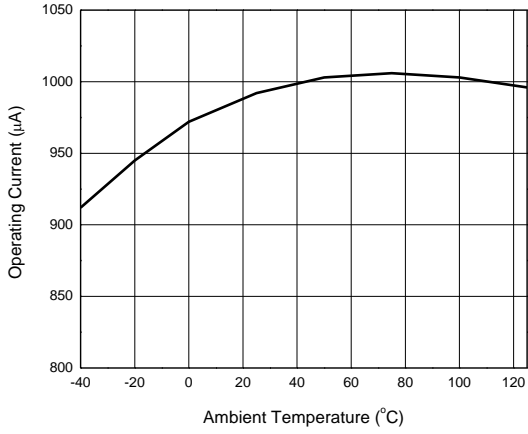

CV Threshold vs. Ambient Temperature

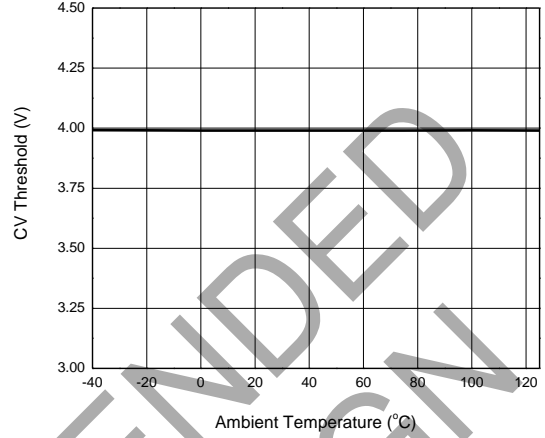

FB Input Leakage Current vs. Ambient Temperature

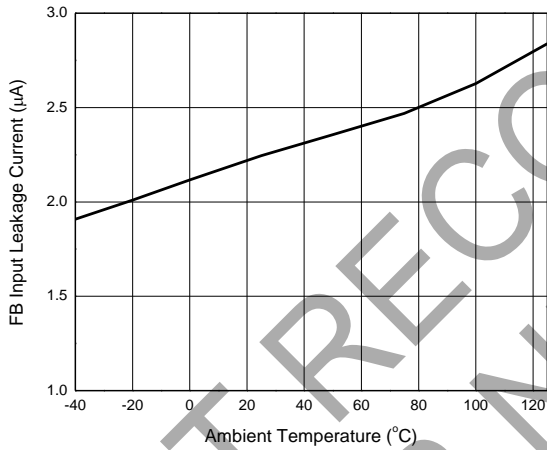

NOT RECOMMENDED FOR NEW DESIGN

Ordering Information

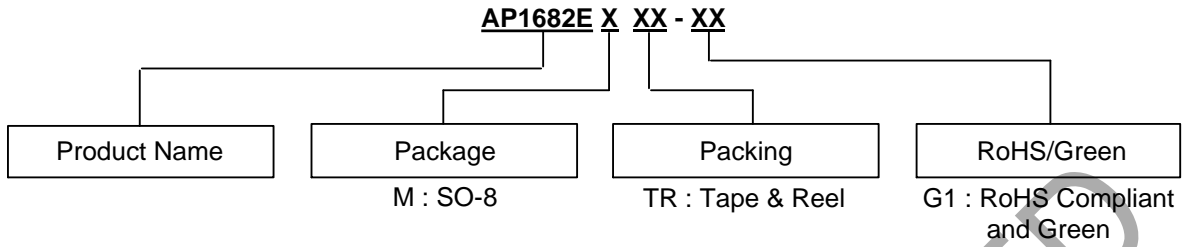

Package	Temperature Range	Part Number	Marking ID	Packing
SO-8	-40°C to +105°C	AP1682EMTR-G1	1682EM-G1	4000/13" Tape & Reel

Marking Information

(Top View)

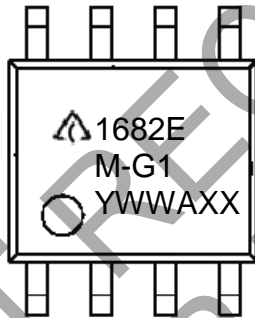

First and Second Lines: Logo and Marking ID
 Third Line: Date Code
 Y: Year
 WW: Work Week of Molding
 A: Assembly House Code
 XX: 7th and 8th Digits of Batch Number

Package Outline Dimensions (All dimensions in mm (inch).)

(1) Package Type: SO-8

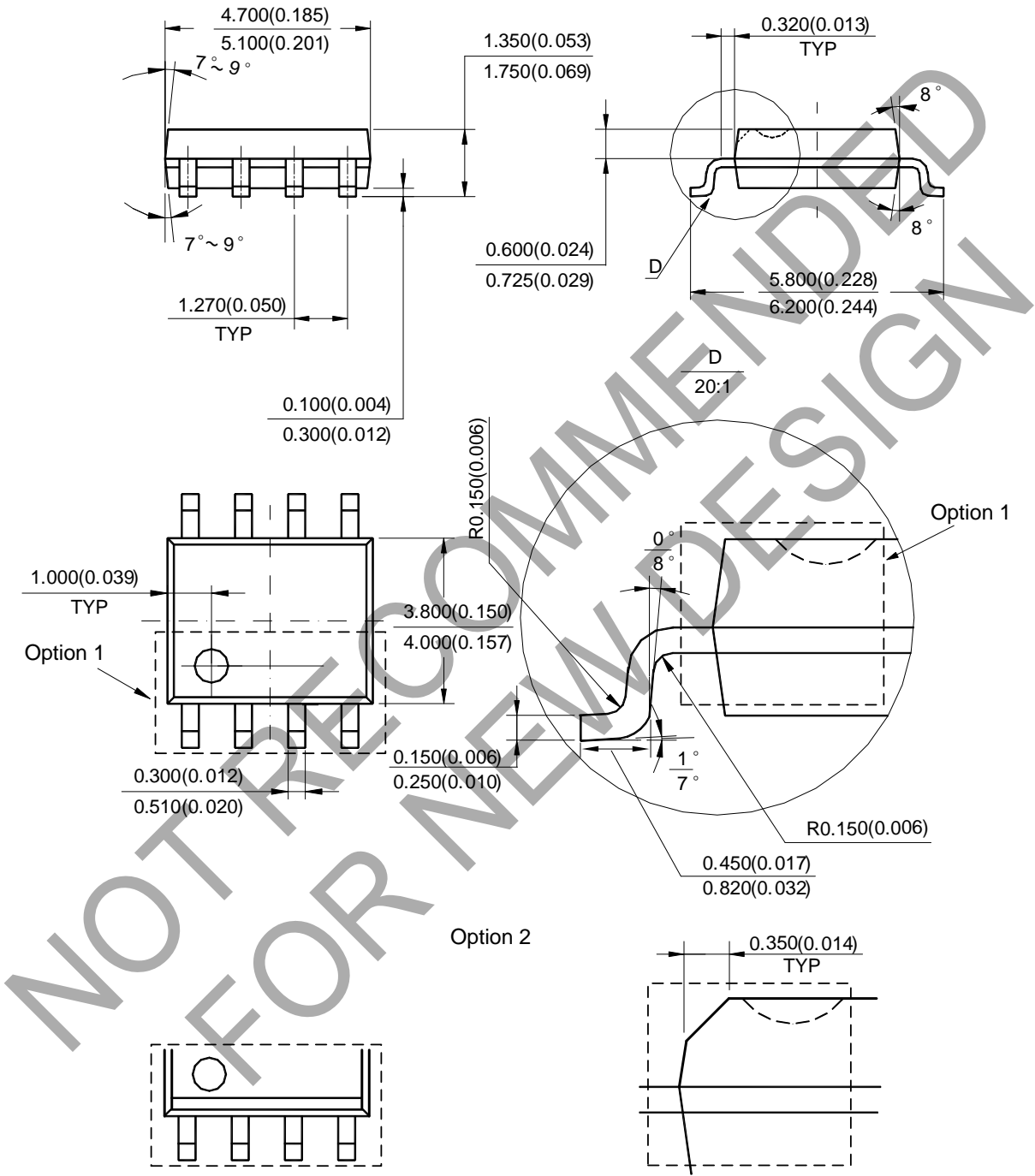

Note: Eject hole, oriented hole and mold mark is optional.

Suggested Pad Layout

(1) Package Type: SO-8

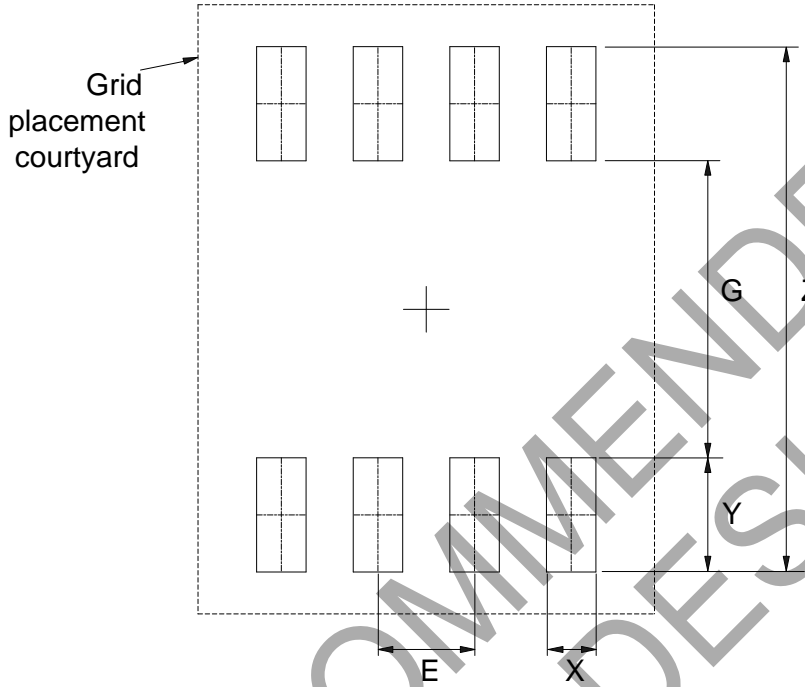

Dimensions	Z (mm)/(inch)	G (mm)/(inch)	X (mm)/(inch)	Y (mm)/(inch)	E (mm)/(inch)
Value	6.900/0.272	3.900/0.154	0.650/0.026	1.500/0.059	1.270/0.050

NOT RECOMMENDED FOR NEW DESIGN

IMPORTANT NOTICE

DIODES INCORPORATED MAKES NO WARRANTY OF ANY KIND, EXPRESS OR IMPLIED, WITH REGARDS TO THIS DOCUMENT, INCLUDING, BUT NOT LIMITED TO, THE IMPLIED WARRANTIES OF MERCHANTABILITY AND FITNESS FOR A PARTICULAR PURPOSE (AND THEIR EQUIVALENTS UNDER THE LAWS OF ANY JURISDICTION).

Diodes Incorporated and its subsidiaries reserve the right to make modifications, enhancements, improvements, corrections or other changes without further notice to this document and any product described herein. Diodes Incorporated does not assume any liability arising out of the application or use of this document or any product described herein; neither does Diodes Incorporated convey any license under its patent or trademark rights, nor the rights of others. Any Customer or user of this document or products described herein in such applications shall assume all risks of such use and will agree to hold Diodes Incorporated and all the companies whose products are represented on Diodes Incorporated website, harmless against all damages.

Diodes Incorporated does not warrant or accept any liability whatsoever in respect of any products purchased through unauthorized sales channel. Should Customers purchase or use Diodes Incorporated products for any unintended or unauthorized application, Customers shall indemnify and hold Diodes Incorporated and its representatives harmless against all claims, damages, expenses, and attorney fees arising out of, directly or indirectly, any claim of personal injury or death associated with such unintended or unauthorized application.

Products described herein may be covered by one or more United States, international or foreign patents pending. Product names and markings noted herein may also be covered by one or more United States, international or foreign trademarks.

This document is written in English but may be translated into multiple languages for reference. Only the English version of this document is the final and determinative format released by Diodes Incorporated.

LIFE SUPPORT

Diodes Incorporated products are specifically not authorized for use as critical components in life support devices or systems without the express written approval of the Chief Executive Officer of Diodes Incorporated. As used herein:

A. Life support devices or systems are devices or systems which:

1. are intended to implant into the body, or
2. support or sustain life and whose failure to perform when properly used in accordance with instructions for use provided in the labeling can be reasonably expected to result in significant injury to the user.

B. A critical component is any component in a life support device or system whose failure to perform can be reasonably expected to cause the failure of the life support device or to affect its safety or effectiveness.

Customers represent that they have all necessary expertise in the safety and regulatory ramifications of their life support devices or systems, and acknowledge and agree that they are solely responsible for all legal, regulatory and safety-related requirements concerning their products and any use of Diodes Incorporated products in such safety-critical, life support devices or systems, notwithstanding any devices- or systems-related information or support that may be provided by Diodes Incorporated. Further, Customers must fully indemnify Diodes Incorporated and its representatives against any damages arising out of the use of Diodes Incorporated products in such safety-critical, life support devices or systems.

Copyright © 2020, Diodes Incorporated

www.diodes.com