

# Depletion Mode MOSFET

**IXTY08N100D2**  
**IXTA08N100D2**  
**IXTP08N100D2**

$V_{DSX} = 1000V$   
 $I_{D(on)} \geq 800mA$   
 $R_{DS(on)} \leq 21\Omega$

## N-Channel

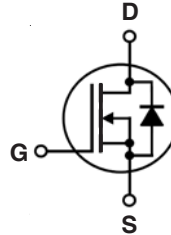

### TO-252 (IXTY)

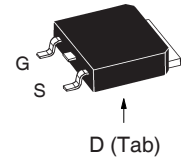

### TO-263 AA (IXTA)

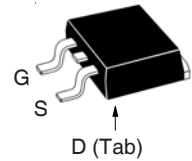

### TO-220AB (IXTP)

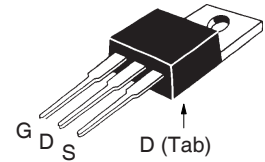

G = Gate      D = Drain  
S = Source    Tab = Drain

| Symbol     | Test Conditions                        | Maximum Ratings |            |
|------------|--|-----------------|------------|
| $V_{DSX}$  | $T_J = 25^\circ C$ to $150^\circ C$    | 1000            | V          |
| $V_{GSX}$  | Continuous                             | $\pm 20$        | V          |
| $V_{GSM}$  | Transient                              | $\pm 30$        | V          |
| $P_D$      | $T_C = 25^\circ C$                     | 60              | W          |
| $T_J$      |  | - 55 ... +150   | $^\circ C$ |
| $T_{JM}$   |  | 150             | $^\circ C$ |
| $T_{stg}$  |  | - 55 ... +150   | $^\circ C$ |
| $T_L$      | Maximum Lead Temperature for Soldering | 300             | $^\circ C$ |
| $T_{SOLD}$ | 1.6 mm (0.062in.) from Case for 10s    | 260             | $^\circ C$ |
| $M_d$      | Mounting Torque (TO-220)               | 1.13 / 10       | Nm/lb.in.  |
| Weight     | TO-252                                 | 0.35            | g          |
|            | TO-263                                 | 2.50            | g          |
|            | TO-220                                 | 3.00            | g          |

| Symbol         | Test Conditions<br>( $T_J = 25^\circ C$ , Unless Otherwise Specified) | Characteristic Values |      |                         |
|----------------|---|-----------------------|------|-------------------------|
|                |   | Min.                  | Typ. | Max.                    |
| $BV_{DSX}$     | $V_{GS} = -5V, I_D = 25\mu A$   | 1000                  |      | V                       |
| $V_{GS(off)}$  | $V_{DS} = 25V, I_D = 25\mu A$   | - 2.0                 |      | V                       |
| $I_{GSX}$      | $V_{GS} = \pm 20V, V_{DS} = 0V$                                       |                       |      | $\pm 50$ nA             |
| $I_{DSX(off)}$ | $V_{DS} = V_{DSX}, V_{GS} = -5V$<br>$T_J = 125^\circ C$               |                       |      | 1 $\mu A$<br>15 $\mu A$ |
| $R_{DS(on)}$   | $V_{GS} = 0V, I_D = 400mA, \text{ Note 1}$                            |                       |      | 21 $\Omega$             |
| $I_{D(on)}$    | $V_{GS} = 0V, V_{DS} = 50V, \text{ Note 1}$                           | 800                   |      | mA                      |

## Features

- Normally ON Mode
- International Standard Packages
- Molding Epoxies Meet UL 94 V-0 Flammability Classification

## Advantages

- Easy to Mount
- Space Savings
- High Power Density

## Applications

- Audio Amplifiers
- Start-up Circuits
- Protection Circuits
- Ramp Generators
- Current Regulators
- Active Loads

| Symbol       | Test Conditions<br>( $T_J = 25^\circ\text{C}$ , Unless Otherwise Specified)   | Characteristic Values |      |                         |
|--------------|---|-----------------------|------|-------------------------|
|              |   | Min.                  | Typ. | Max.                    |
| $g_{fs}$     | $V_{DS} = 30\text{V}$ , $I_D = 400\text{mA}$ , Note 1   | 330                   | 560  | mS                      |
| $C_{iss}$    | $V_{GS} = -10\text{V}$ , $V_{DS} = 25\text{V}$ , $f = 1\text{MHz}$  |                       | 325  | pF                      |
| $C_{oss}$    |   |                       | 24   | pF                      |
| $C_{rss}$    |   |                       | 6.5  | pF                      |
| $t_{d(on)}$  | <b>Resistive Switching Times</b><br>$V_{GS} = \pm 5\text{V}$ , $V_{DS} = 500\text{V}$ , $I_D = 400\text{mA}$<br>$R_G = 10\Omega$ (External) |                       | 28   | ns                      |
| $t_r$        |   |                       | 57   | ns                      |
| $t_{d(off)}$ |   |                       | 34   | ns                      |
| $t_f$        |   |                       | 48   | ns                      |
| $Q_{g(on)}$  | $V_{GS} = 5\text{V}$ , $V_{DS} = 500\text{V}$ , $I_D = 400\text{mA}$  |                       | 14.6 | nC                      |
| $Q_{gs}$     |   |                       | 1.2  | nC                      |
| $Q_{gd}$     |   |                       | 8.3  | nC                      |
| $R_{thJC}$   | TO-220  |                       |      | 2.08 $^\circ\text{C/W}$ |
| $R_{thCS}$   |   |                       | 0.50 | $^\circ\text{C/W}$      |

**Safe-Operating-Area Specification**

| Symbol | Test Conditions   | Characteristic Values |      |      |
|--------|---|-----------------------|------|------|
|        |   | Min.                  | Typ. | Max. |
| SOA    | $V_{DS} = 800\text{V}$ , $I_D = 45\text{mA}$ , $T_C = 75^\circ\text{C}$ , $T_p = 5\text{s}$ | 36                    |      | W    |

**Source-Drain Diode**

| Symbol   | Test Conditions<br>( $T_J = 25^\circ\text{C}$ , Unless Otherwise Specified)                               | Characteristic Values |      |               |
|----------|---|-----------------------|------|---------------|
|          |   | Min.                  | Typ. | Max.          |
| $V_{SD}$ | $I_F = 800\text{mA}$ , $V_{GS} = -10\text{V}$ , Note 1  |                       | 0.8  | 1.3 V         |
| $t_{rr}$ | $I_F = 800\text{mA}$ , $-di/dt = 100\text{A}/\mu\text{s}$<br>$V_R = 100\text{V}$ , $V_{GS} = -10\text{V}$ |                       | 1.03 | $\mu\text{s}$ |
| $I_{RM}$ |   |                       | 7.40 | A             |
| $Q_{RM}$ |   |                       | 3.80 | $\mu\text{C}$ |

Note 1. Pulse test,  $t \leq 300\mu\text{s}$ , duty cycle,  $d \leq 2\%$ .

IXYS Reserves the Right to Change Limits, Test Conditions, and Dimensions.

IXYS MOSFETs and IGBTs are covered by one or more of the following U.S. patents:

|           |           |           |           |              |              |              |              |              |             |
|-----------|-----------|-----------|-----------|--------------|--------------|--------------|--------------|--------------|-------------|
| 4,835,592 | 4,931,844 | 5,049,961 | 5,237,481 | 6,162,665    | 6,404,065 B1 | 6,683,344    | 6,727,585    | 7,005,734 B2 | 7,157,338B2 |
| 4,860,072 | 5,017,508 | 5,063,307 | 5,381,025 | 6,259,123 B1 | 6,534,343    | 6,710,405 B2 | 6,759,692    | 7,063,975 B2 |             |
| 4,881,106 | 5,034,796 | 5,187,117 | 5,486,715 | 6,306,728 B1 | 6,583,505    | 6,710,463    | 6,771,478 B2 | 7,071,537    |             |

Fig. 1. Output Characteristics @  $T_J = 25^\circ\text{C}$

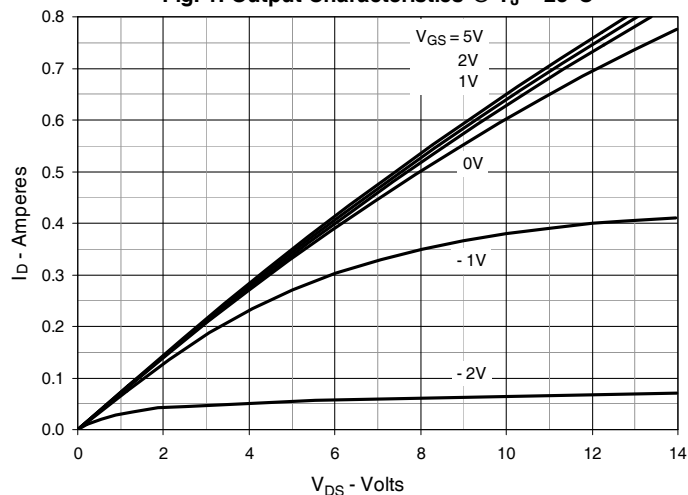

Fig. 2. Extended Output Characteristics @  $T_J = 25^\circ\text{C}$

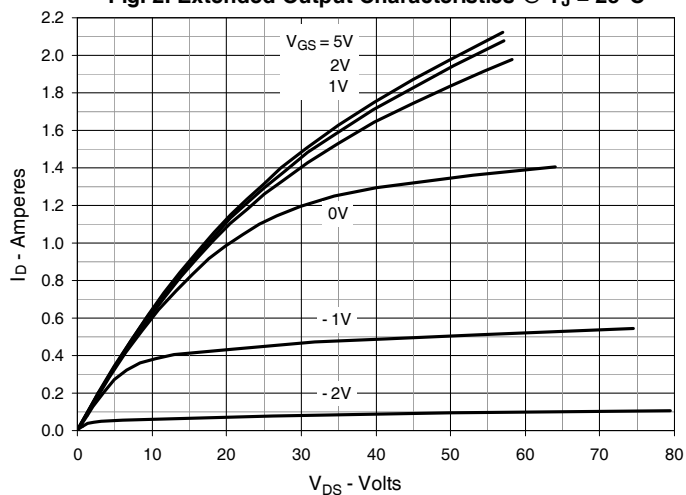

Fig. 3. Output Characteristics @  $T_J = 125^\circ\text{C}$

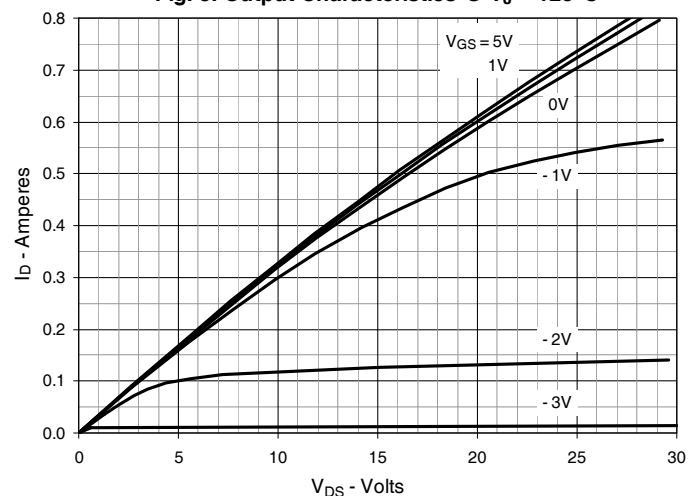

Fig. 4. Drain Current @  $T_J = 25^\circ\text{C}$

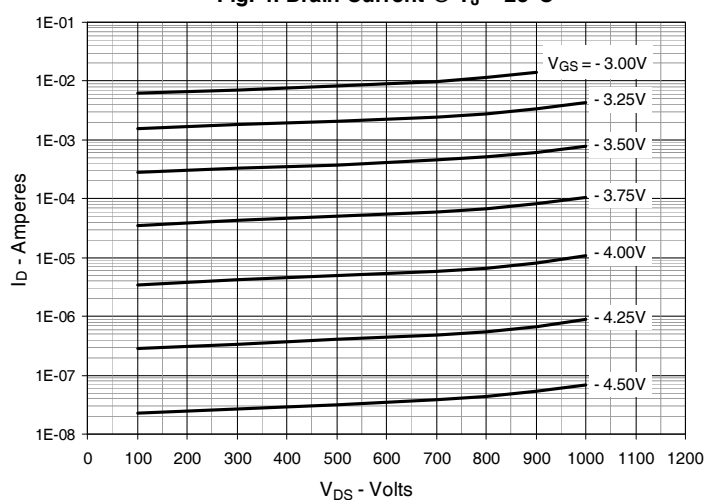

Fig. 5. Drain Current @  $T_J = 100^\circ\text{C}$

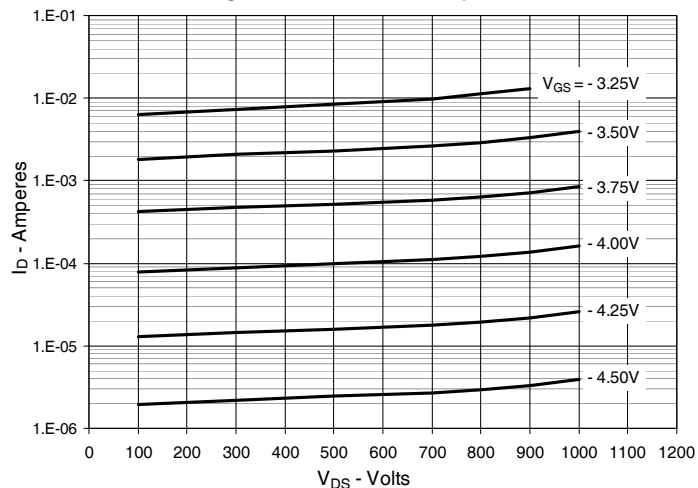

Fig. 6. Dynamic Resistance vs. Gate Voltage

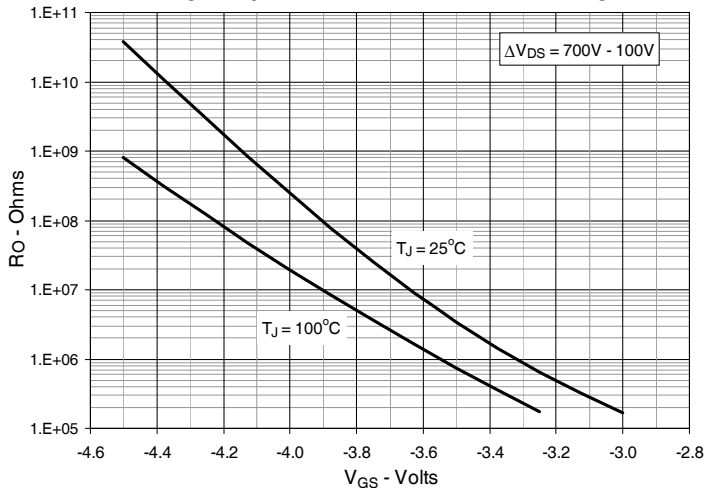

Fig. 7. Normalized  $R_{DS(on)}$  vs. Junction Temperature

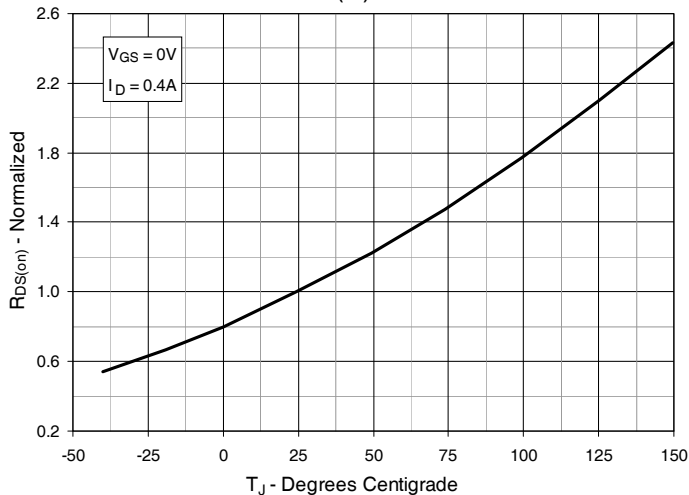

Fig. 8.  $R_{DS(on)}$  Normalized to  $I_D = 0.4A$  Value vs. Drain Current

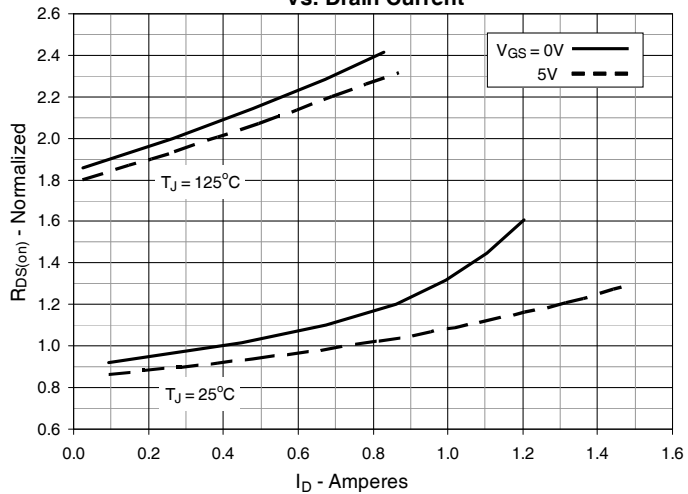

Fig. 9. Input Admittance

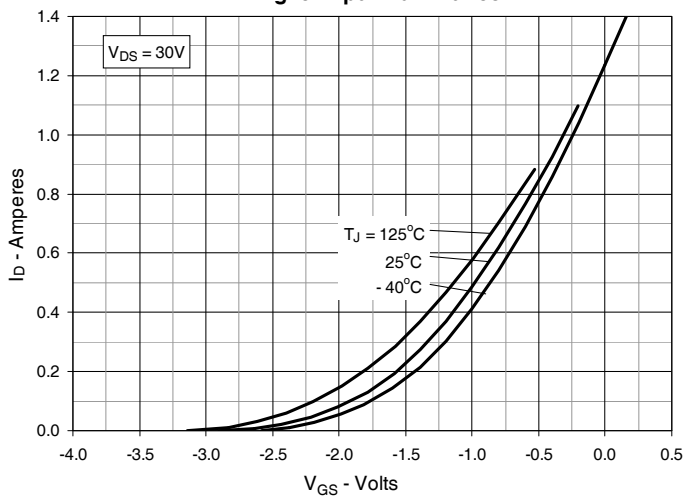

Fig. 10. Transconductance

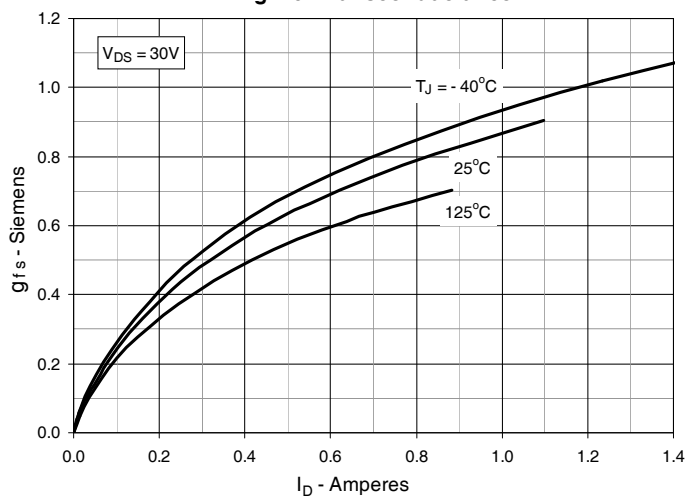

Fig. 11. Breakdown and Threshold Voltages vs. Junction Temperature

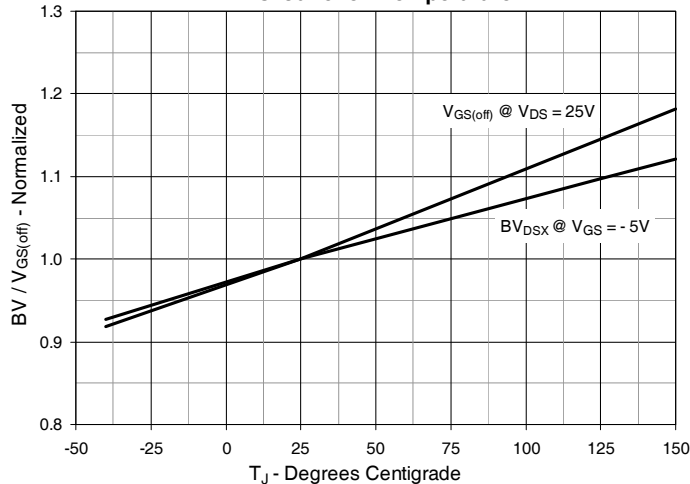

Fig. 12. Forward Voltage Drop of Intrinsic Diode

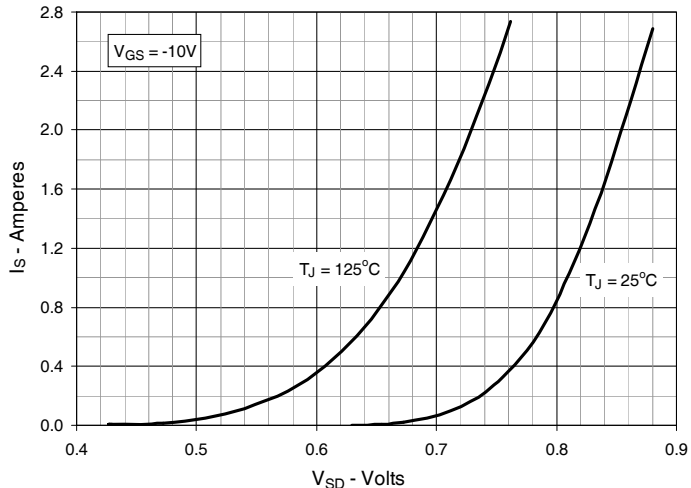

Fig. 13. Capacitance

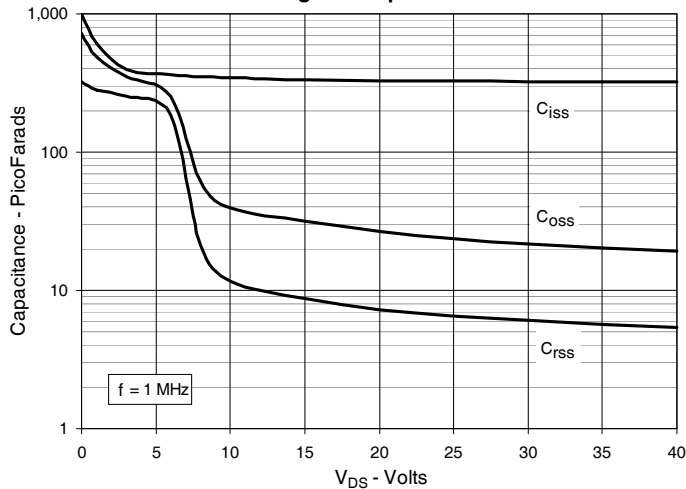

Fig. 14. Gate Charge

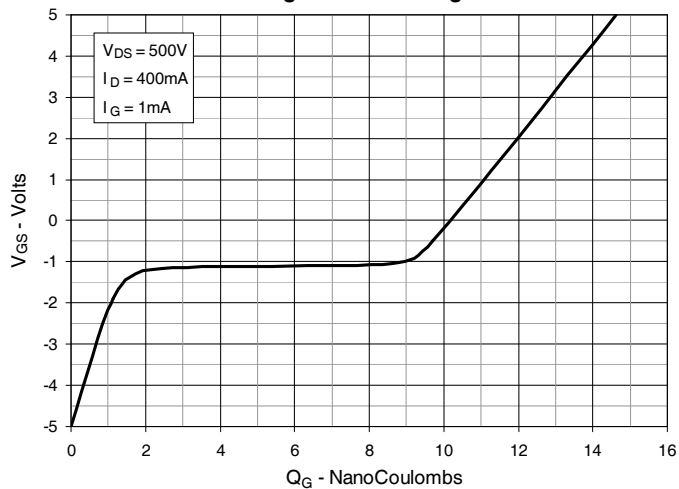

Fig. 15. Forward-Bias Safe Operating Area  
@  $T_C = 25^\circ\text{C}$

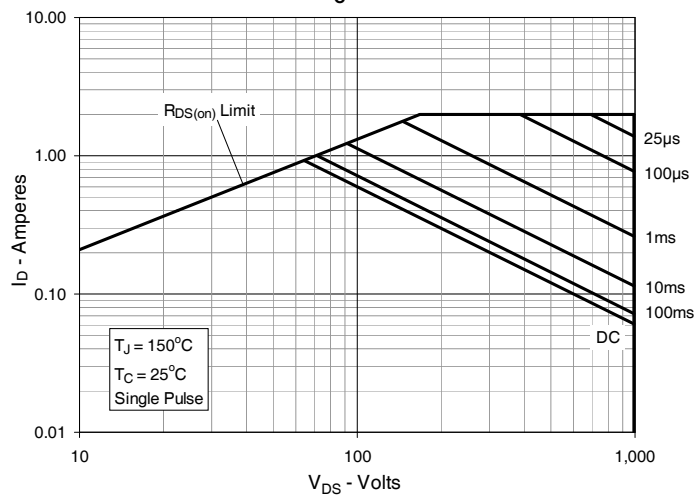

Fig. 16. Forward-Bias Safe Operating Area  
@  $T_C = 75^\circ\text{C}$

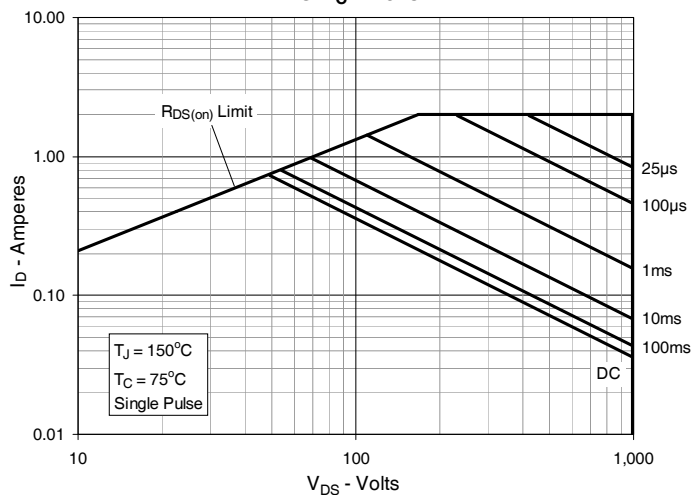
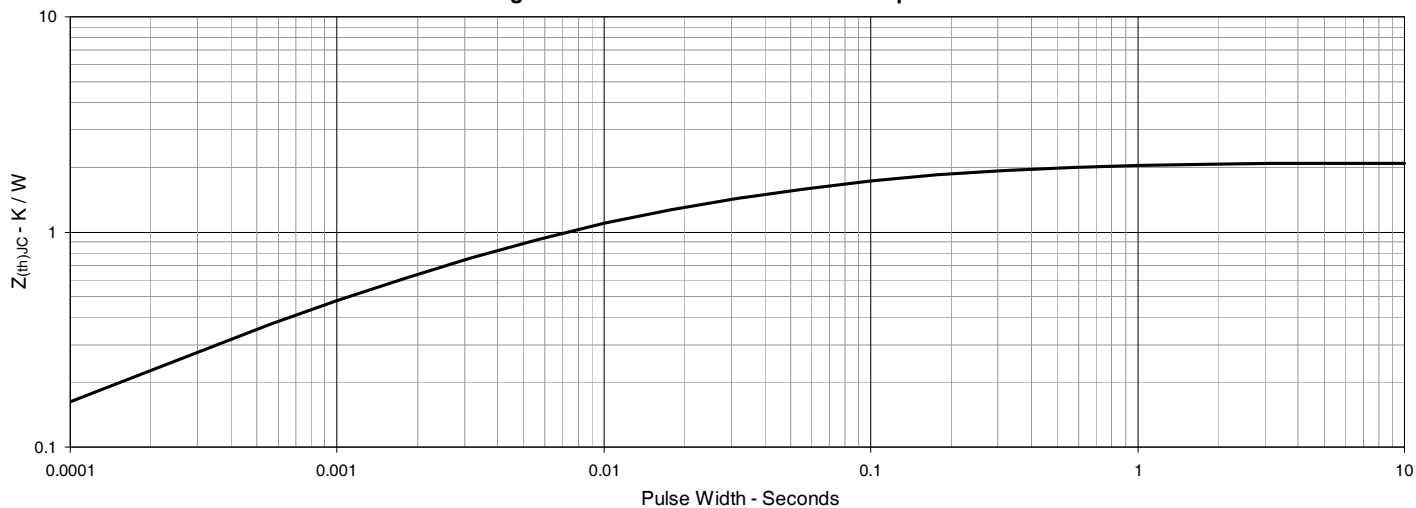
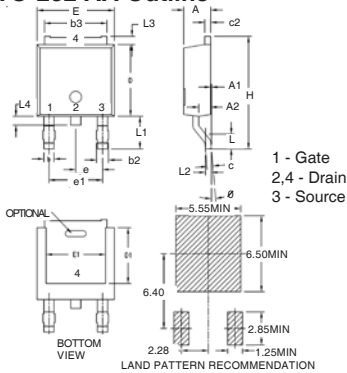

Fig. 17. Maximum Transient Thermal Impedance



**TO-252 AA Outline**



| SYM | INCHES   |      | MILLIMETERS |       |
|-----|----------|------|-------------|-------|
|     | MIN      | MAX  | MIN         | MAX   |
| A   | .086     | .094 | 2.19        | 2.38  |
| A1  | 0        | .005 | 0           | 0.12  |
| A2  | .038     | .046 | 0.97        | 1.17  |
| b   | .025     | .035 | 0.64        | 0.89  |
| b2  | .030     | .045 | 0.76        | 1.14  |
| b3  | .200     | .215 | 5.08        | 5.46  |
| c   | .018     | .024 | 0.46        | 0.61  |
| c2  | .018     | .023 | 0.46        | 0.58  |
| D   | .235     | .245 | 5.97        | 6.22  |
| D1  | .180     | .205 | 4.57        | 5.21  |
| E   | .250     | .265 | 6.35        | 6.73  |
| E1  | .170     | .205 | 4.32        | 5.21  |
| e   | .090 BSC |      | 2.28 BSC    |       |
| e1  | .180 BSC |      | 4.57 BSC    |       |
| H   | .370     | .410 | 9.40        | 10.42 |
| L   | .055     | .070 | 1.40        | 1.78  |
| L1  | .100     | .115 | 2.54        | 2.92  |
| L2  | .020 BSC |      | 0.50 BSC    |       |
| L3  | .025     | .040 | 0.64        | 1.02  |
| L4  | .025     | .040 | 0.64        | 1.02  |
| ø   | 0°       | 10°  | 0°          | 10°   |

**TO-263 Outline**

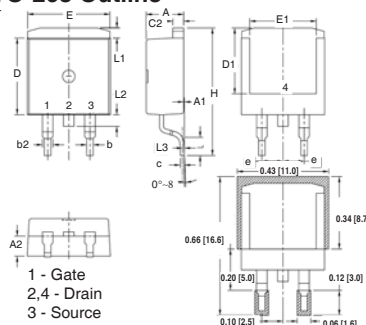

| SYM  | INCHES   |      | MILLIMETER |       |
|------|----------|------|------------|-------|
|      | MIN      | MAX  | MIN        | MAX   |
| A    | .170     | .185 | 4.30       | 4.70  |
| A1   | .000     | .008 | 0.00       | 0.20  |
| A2   | .091     | .098 | 2.30       | 2.50  |
| b    | .028     | .035 | 0.70       | 0.90  |
| b2   | .046     | .060 | 1.18       | 1.52  |
| C    | .018     | .024 | 0.45       | 0.60  |
| C2   | .049     | .060 | 1.25       | 1.52  |
| D    | .340     | .370 | 8.63       | 9.40  |
| D1   | .300     | .327 | 7.62       | 8.30  |
| E    | .380     | .410 | 9.65       | 10.41 |
| E1   | .270     | .330 | 6.86       | 8.38  |
| [e]  | .100 BSC |      | 2.54 BSC   |       |
| H    | .580     | .620 | 14.73      | 15.75 |
| L    | .075     | .105 | 1.91       | 2.67  |
| L1   | .039     | .060 | 1.00       | 1.52  |
| L2   | —        | .070 | —          | 1.77  |
| [L3] | .010 BSC |      | 0.254 BSC  |       |

**TO-220 Outline**

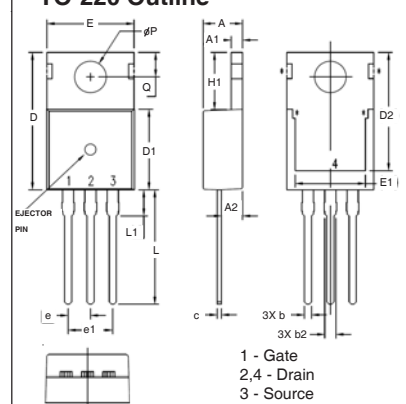

| SYM  | INCHES   |      | MILLIMETERS |       |
|------|----------|------|-------------|-------|
|      | MIN      | MAX  | MIN         | MAX   |
| A    | .169     | .185 | 4.30        | 4.70  |
| A1   | .047     | .055 | 1.20        | 1.40  |
| A2   | .079     | .106 | 2.00        | 2.70  |
| b    | .024     | .039 | 0.60        | 1.00  |
| b2   | .045     | .057 | 1.15        | 1.45  |
| c    | .014     | .026 | 0.35        | 0.65  |
| D    | .587     | .626 | 14.90       | 15.90 |
| D1   | .335     | .370 | 8.50        | 9.40  |
| (D2) | .500     | .531 | 12.70       | 13.50 |
| E    | .382     | .406 | 9.70        | 10.30 |
| (E1) | .283     | .323 | 7.20        | 8.20  |
| e    | .100 BSC |      | 2.54 BSC    |       |
| e1   | .200 BSC |      | 5.08 BSC    |       |
| H1   | .244     | .268 | 6.20        | 6.80  |
| L    | .492     | .547 | 12.50       | 13.90 |
| L1   | .110     | .154 | 2.80        | 3.90  |
| ∅P   | .134     | .150 | 3.40        | 3.80  |
| Q    | .106     | .126 | 2.70        | 3.20  |



---

Disclaimer Notice - Information furnished is believed to be accurate and reliable. However, users should independently evaluate the suitability of and test each product selected for their own applications. Littelfuse products are not designed for, and may not be used in, all applications. Read complete Disclaimer Notice at [www.littelfuse.com/disclaimer-electronics](http://www.littelfuse.com/disclaimer-electronics).