

Features

- Power dissipation of 350mW
- High stability and high reliability

Mechanical Data

- SOT-23 small outline plastic package
- Epoxy UL: 94V-0
- Mounting position: Any

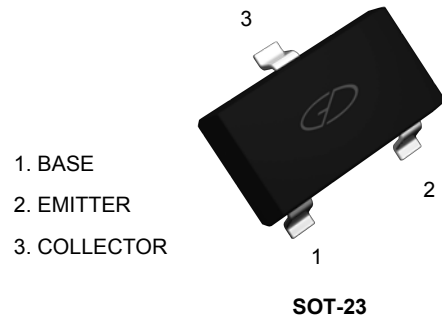

Absolute Maximum Ratings ($T_A=25^{\circ}\text{C}$ unless otherwise noted)

Parameter	Symbol	Rating	Unit
Collector - Base Voltage	V_{CBO}	300	V
Collector - Emitter Voltage	V_{CEO}	300	V
Emitter - Base Voltage	V_{EBO}	5	V
Collector Current - Continuous	I_C	300	mA
Collector Power Dissipation	P_C	350	mW
Thermal Resistance from Junction to Ambient	$R_{\theta JA}$	357	$^{\circ}\text{C}/\text{W}$
Junction Temperature	T_J	-55 to +150	$^{\circ}\text{C}$
Storage Temperature	T_{STG}	-55 to +150	$^{\circ}\text{C}$

Electrical Characteristics ($T_A=25^{\circ}\text{C}$ unless otherwise noted)

Parameter	Symbol	Conditions	Min	Max	Unit
Collector-Base Breakdown Voltage	$V_{(BR)CEO}$	$I_C=100\mu\text{A}, I_E=0$	300	-	V
Collector-Emitter Breakdown Voltage	$V_{(BR)CBO}$	$I_C=1\text{mA}, I_B=0$	300	-	V
Emitter-Base Breakdown Voltage	$V_{(BR)EBO}$	$I_E=10\mu\text{A}, I_C=0$	5	-	V
Collector Cut-off Current	I_{CBO}	$V_{CB}=200\text{V}, I_E=0$	-	250	nA
Emitter Cut-off Current	I_{EBO}	$V_{EB}=5\text{V}, I_C=0$	-	100	nA
DC Current Gain ¹	$h_{FE(1)}$	$V_{CE}=10\text{V}, I_C=1\text{mA}$	60	-	-
	$h_{FE(2)}$	$V_{CE}=10\text{V}, I_C=10\text{mA}$	100	200	-
	$h_{FE(3)}$	$V_{CE}=10\text{V}, I_C=30\text{mA}$	65	-	-
Collector-Emitter Saturation Voltage ¹	$V_{CE(sat)}$	$I_C=20\text{mA}, I_B=2\text{mA}$	-	0.20	V
Base-Emitter Voltage ¹	$V_{BE(sat)}$	$I_C=20\text{mA}, I_B=2\text{mA}$	-	0.90	V
Transition Frequency	f_t	$V_{CE}=20\text{V}, I_C=100\text{mA}$ $F=30\text{MHz}$	50	-	MHz

Note: 1) Pulse test: pulse width $\leq 300\mu\text{s}$, duty cycle $\leq 2\%$.

Typical Electrical and Thermal Characteristic Curves

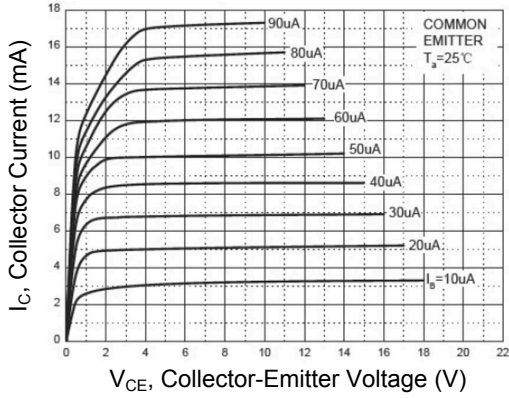

Figure 1. Collector Current vs. Collector - Emitter Voltage

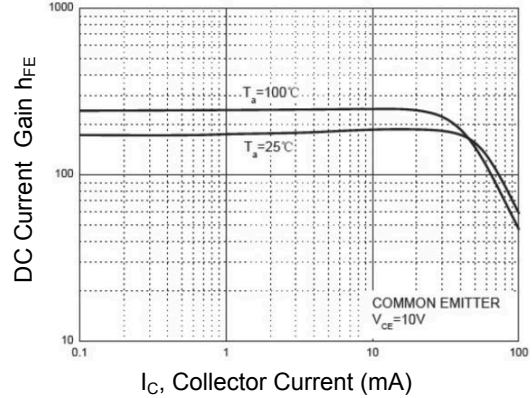

Figure 2. DC Current Gain vs. Collector Current

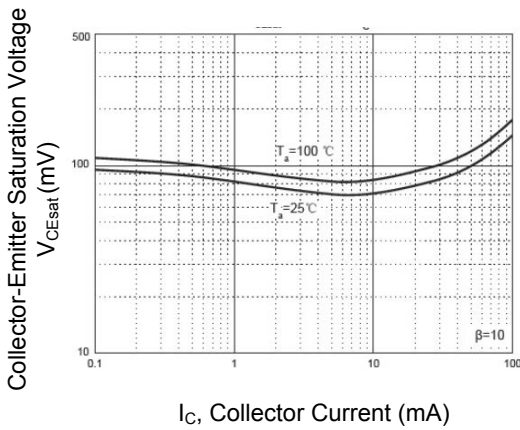

Figure 3. Collector-Emitter Saturation Voltage vs. Collector Current

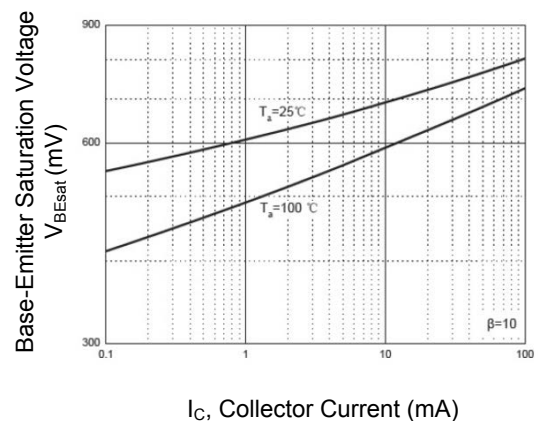

Figure 4. Base-Emitter Saturation Voltage vs. Collector Current

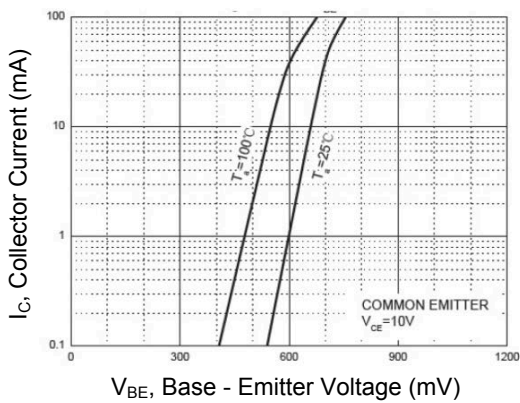

Figure 5. Collector Current vs. Base - Emitter Voltage

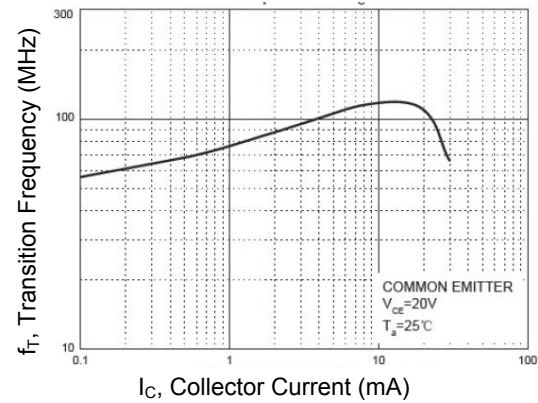

Figure 6. f_T vs. Collector Current

Typical Electrical and Thermal Characteristic Curves

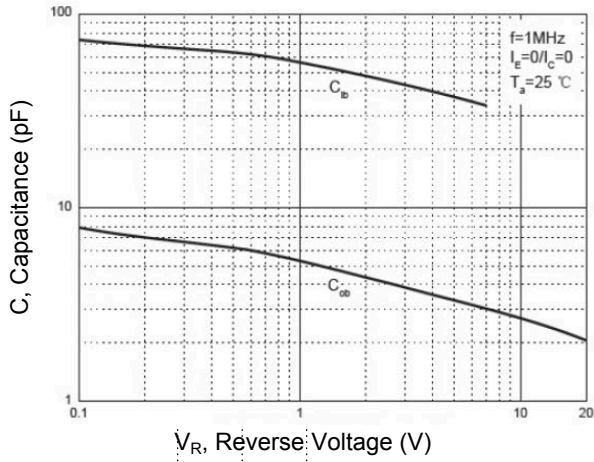

Figure 7. Capacitance Characteristics

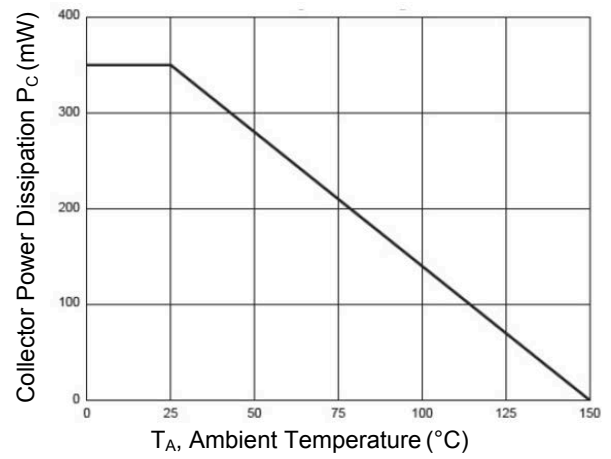
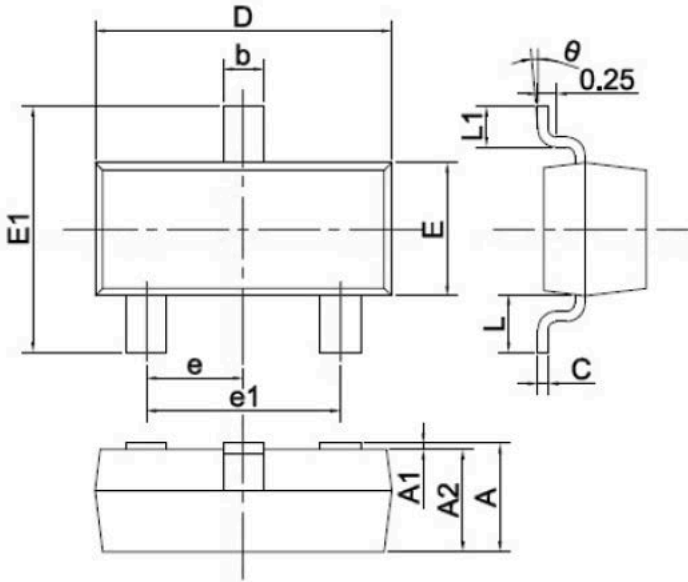

Figure 8. Power Dissipation vs Ambient Temperature

Package Outline Dimensions (SOT-23)



Symbol	Dimensions in Millimeters	
	Min	Max
A	0.900	1.150
A1	0.000	0.100
A2	0.900	1.050
b	0.300	0.500
c	0.080	0.150
D	2.800	3.000
E	1.200	1.400
E1	2.250	2.550
e	0.950 TYP.	
e1	1.800	2.000
L	0.550 REF.	
L1	0.300	0.500
θ	0°	8°

Recommended Pad Layout

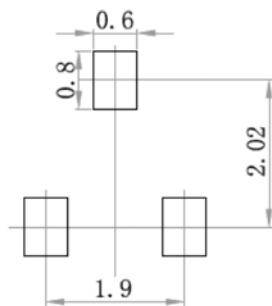

Note:

1. Controlling dimensions: in millimeters.
2. General tolerance: $\pm 0.05\text{mm}$.
3. The pad layout is for reference purposes only.