



Is Now Part of



ON Semiconductor®

To learn more about ON Semiconductor, please visit our website at
www.onsemi.com

Please note: As part of the Fairchild Semiconductor integration, some of the Fairchild orderable part numbers will need to change in order to meet ON Semiconductor's system requirements. Since the ON Semiconductor product management systems do not have the ability to manage part nomenclature that utilizes an underscore (_), the underscore (_) in the Fairchild part numbers will be changed to a dash (-). This document may contain device numbers with an underscore (_). Please check the ON Semiconductor website to verify the updated device numbers. The most current and up-to-date ordering information can be found at www.onsemi.com. Please email any questions regarding the system integration to Fairchild_questions@onsemi.com.

ON Semiconductor and the ON Semiconductor logo are trademarks of Semiconductor Components Industries, LLC dba ON Semiconductor or its subsidiaries in the United States and/or other countries. ON Semiconductor owns the rights to a number of patents, trademarks, copyrights, trade secrets, and other intellectual property. A listing of ON Semiconductor's product/patent coverage may be accessed at www.onsemi.com/site/pdf/Patent-Marking.pdf. ON Semiconductor reserves the right to make changes without further notice to any products herein. ON Semiconductor makes no warranty, representation or guarantee regarding the suitability of its products for any particular purpose, nor does ON Semiconductor assume any liability arising out of the application or use of any product or circuit, and specifically disclaims any and all liability, including without limitation special, consequential or incidental damages. Buyer is responsible for its products and applications using ON Semiconductor products, including compliance with all laws, regulations and safety requirements or standards, regardless of any support or applications information provided by ON Semiconductor. "Typical" parameters which may be provided in ON Semiconductor data sheets and/or specifications can and do vary in different applications and actual performance may vary over time. All operating parameters, including "Typicals" must be validated for each customer application by customer's technical experts. ON Semiconductor does not convey any license under its patent rights nor the rights of others. ON Semiconductor products are not designed, intended, or authorized for use as a critical component in life support systems or any FDA Class 3 medical devices or medical devices with a same or similar classification in a foreign jurisdiction or any devices intended for implantation in the human body. Should Buyer purchase or use ON Semiconductor products for any such unintended or unauthorized application, Buyer shall indemnify and hold ON Semiconductor and its officers, employees, subsidiaries, affiliates, and distributors harmless against all claims, costs, damages, and expenses, and reasonable attorney fees arising out of, directly or indirectly, any claim of personal injury or death associated with such unintended or unauthorized use, even if such claim alleges that ON Semiconductor was negligent regarding the design or manufacture of the part. ON Semiconductor is an Equal Opportunity/Affirmative Action Employer. This literature is subject to all applicable copyright laws and is not for resale in any manner.

FAN73833

Half-Bridge Gate-Drive IC

Features

- Floating Channel for Bootstrap Operation to +600V
- Typically 350 mA / 650 mA Sourcing/Sinking Current Driving Capability for Both Channels
- Extended Allowable Negative V_S Swing to -9.8 V for Signal Propagation at $V_{DD}=V_{BS}=15$ V
- 3.3 V and 5 V Input Logic Compatible
- Outputs in Phase with Input Signals
- Built-in UVLO Functions for Both Channels
- Built-on Shoot-Through Prevention Circuit
- Built-in Common-Mode dv/dt Noise Canceling Circuit
- Internal Dead-Time Typically 400 ns

Applications

- SMPS
- Motor Drive Inverter
- Fluorescent Lamp Ballast
- HID Ballast

Description

The FAN73833 is a half-bridge gate-drive IC for driving MOSFETs and IGBTs, operating up to +600 V.

Fairchild's high-voltage process and common-mode noise canceling technique provide stable operation of high-side driver under high dv/dt noise circumstances.

An advanced level-shift circuit allows high-side gate driver operation up to $V_S=-9.8$ V (typical) for $V_{BS}=15$ V.

The UVLO circuits for both channels prevent malfunction when V_{DD} and V_{BS} are lower than the specified threshold voltage.

Output drivers typically source/sink 350 mA / 650 mA, respectively, which is suitable for all kinds of half- and full-bridge inverters.

8-SOP



Ordering Information

Part Number	Package	Operating Temperature Range	Packing Method
FAN73833M	8-SOP	-40°C to +125°C	Tube
FAN73833MX			Tape & Reel

Pin Configuration

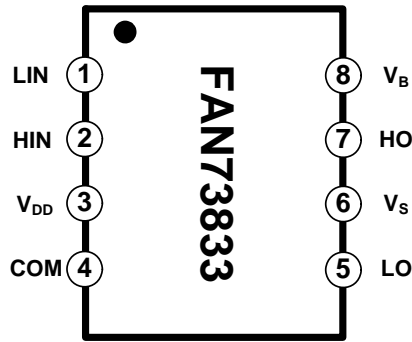

Figure 3. Pin Configuration (Top View)

Pin Definitions

Pin #	Name	Description
1	LIN	Logic Input for Low-Side Driver
2	HIN	Logic Input for High-Side Driver
3	V _{DD}	Low-Side Supply Voltage
4	COM	Logic Ground and Low-Side Driver Return
5	LO	Low-Side Driver Output
6	V _S	High-Side Floating Supply Return
7	HO	High-Side Driver Output
8	V _B	High-Side Floating Supply

Absolute Maximum Ratings

Stresses exceeding the absolute maximum ratings may damage the device. The device may not function or be operable above the recommended operating conditions and stressing the parts to these levels is not recommended. In addition, extended exposure to stresses above the recommended operating conditions may affect device reliability. The absolute maximum ratings are stress ratings only. $T_A=25^{\circ}\text{C}$, unless otherwise specified.

Symbol	Parameter	Min.	Max.	Unit
V_S	High-side offset voltage	V_B-25	$V_B+0.3$	V
V_B	High-side floating supply voltage	-0.3	625	V
V_{HO}	High-side floating output voltage HO	$V_S-0.3$	$V_B+0.3$	V
V_{DD}	Low-side and logic-fixed supply voltage	-0.3	25	V
V_{LO}	Low-side output voltage LO	-0.3	$V_{DD}+0.3$	V
V_{IN}	Logic input voltage (HIN/LIN)	-0.3	$V_{DD}+0.3$	V
COM	Logic ground and low-side driver return	$V_{DD}-25$	$V_{DD}+0.3$	V
dV_S/dt	Allowable offset voltage slew rate		50	V/ns
$P_D^{(1)(2)(3)}$	Power dissipation		0.625	W
θ_{JA}	Thermal resistance, junction-to-ambient		200	$^{\circ}\text{C/W}$
T_J	Junction temperature		150	$^{\circ}\text{C}$
T_{STG}	Storage temperature	-55	150	$^{\circ}\text{C}$

Notes:

- Mounted on 76.2 x 114.3 x 1.6 mm PCB (FR-4 glass epoxy material).
- Refer to the following standards:
 - JESD51-2: Integral circuits thermal test method environmental conditions - natural convection
 - JESD51-3: Low effective thermal conductivity test board for leaded surface mount packages
- Do not exceed P_D under any circumstances.

Recommended Operating Conditions

The Recommended Operating Conditions table defines the conditions for actual device operation. Recommended operating conditions are specified to ensure optimal performance to the datasheet specifications. Fairchild does not recommend exceeding them or designing to Absolute Maximum Ratings.

Symbol	Parameter	Min.	Max.	Unit
V_B	High-side floating supply voltage	V_S+11	V_S+20	V
V_S	High-side floating supply offset voltage	$6-V_{DD}$	600	V
V_{DD}	Low-side supply voltage	11	20	V
V_{HO}	High-side (HO) output voltage	V_S	V_B	V
V_{LO}	Low-side (LO) output voltage	COM	V_{DD}	V
V_{IN}	Logic input voltage (HIN/LIN)	COM	V_{DD}	V
T_A	Ambient temperature	-40	125	$^{\circ}\text{C}$

Electrical Characteristics

V_{BIAS} (V_{DD} , V_{BS}) = 15.0 V, and $T_A=25^\circ\text{C}$, unless otherwise specified. The V_{IN} and I_{IN} parameters are referenced to COM. The V_O and I_O parameters are referenced to V_S and COM and are applicable to respective outputs HO and LO.

Symbol	Parameter	Condition	Min.	Typ.	Max.	Unit
SUPPLY CURRENT SECTION						
I_{QBS}	Quiescent V_{BS} supply current	$V_{IN}=0$ V or 5 V		35	100	μA
I_{QDD}	Quiescent V_{DD} supply current	$V_{IN}=0$ V or 5 V		80	200	μA
I_{PBS}	Operating V_{BS} supply current	$f_{IN}=20$ kHz, rms value		420	750	μA
I_{PDD}	Operating V_{DD} supply current	$f_{IN}=20$ kHz, rms value		420	750	μA
I_{LK}	Offset supply leakage current	$V_B=V_S=600$ V			10	μA
POWER SUPPLY SECTION						
V_{DDUV+} V_{BSUV+}	V_{DD} and V_{BS} supply under-voltage positive going threshold		8.2	9.2	10.1	V
V_{DDUV-} V_{BSUV-}	V_{DD} and V_{BS} supply under-voltage negative going threshold		7.2	8.3	9.2	V
V_{DDUVH} V_{BSUVH}	V_{DD} supply under-voltage lockout hysteresis			0.9		V
GATE DRIVER OUTPUT SECTION						
V_{OH}	High-level output voltage, $V_{BIAS}-V_O$	$I_O=20$ mA			1.0	V
V_{OL}	Low-level output voltage, V_O				0.6	V
$I_{O+}^{(4)}$	Output high short-circuit pulse current	$V_O=0$ V, $V_{IN}=5$ V with $PW<10$ μs	250	350		mA
$I_{O-}^{(4)}$	Output low short-circuit pulsed current	$V_O=15$ V, $V_{IN}=0$ V with $PW<10$ μs	500	650		mA
V_S	Allowable negative V_S pin voltage for IN signal propagation to HO			-9.8	-7.0	V
LOGIC INPUT SECTION (INPUT and SHUTDOWN)						
V_{IH}	Logic "1" input voltage		2.5			V
V_{IL}	Logic "0" input voltage				1.2	V
I_{IN+}	Logic "1" input bias current	$V_{IN}=5$ V		50	100	μA
I_{IN-}	Logic "0" input bias current	$V_{IN}=0$ V			2.0	μA
R_{PD}	Input pull-down resistance			100		$\text{K}\Omega$

Note:

- This parameter is guaranteed by design.

Dynamic Electrical Characteristics

V_{BIAS} (V_{DD} , V_{BS})=15.0 V, V_S =COM, C_L =1000 pF, and T_A = 25°C, unless otherwise specified.

Symbol	Parameter	Conditions	Min.	Typ.	Max.	Unit
t_{ON}	Turn-on propagation delay time	$V_S=0$ V		150	270	ns
t_{OFF}	Turn-off propagation delay time	$V_S=0$ V		140	250	ns
t_R	Turn-on rising time			50	100	ns
t_F	Turn-off falling time			30	80	ns
DT	Dead-time		330	450	580	ns

Typical Characteristics

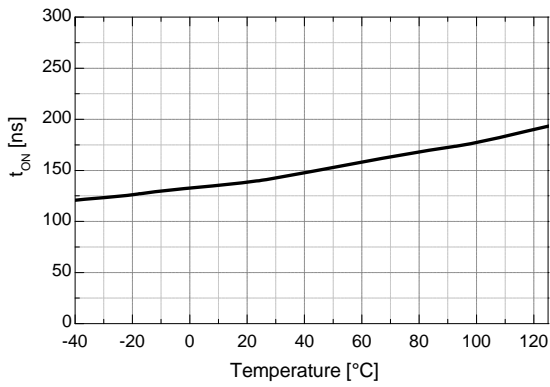

Figure 4. Turn-on Propagation Delay vs. Temp.

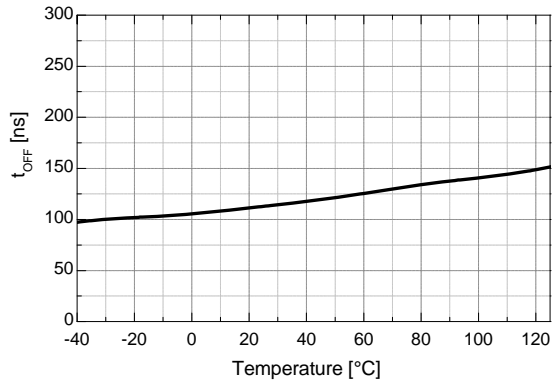

Figure 5. Turn-off Propagation Delay vs. Temp.

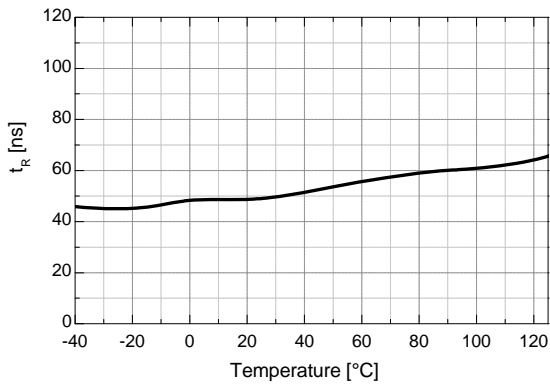

Figure 6. Turn-on Rise Time vs. Temp.

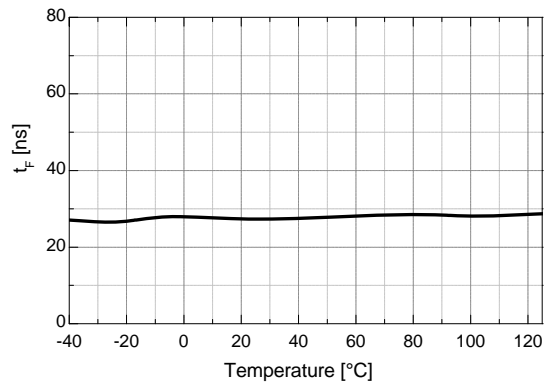

Figure 7. Turn-off Fall Time vs. Temp.

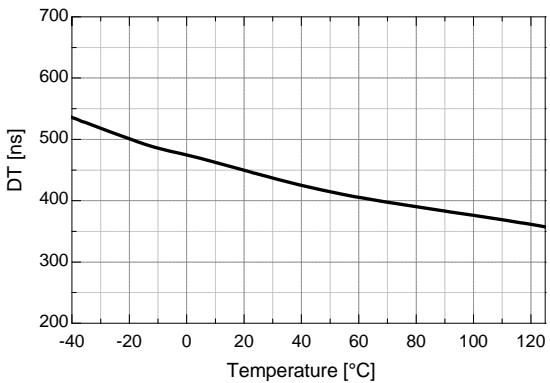

Figure 8. Dead Time vs. Temp.

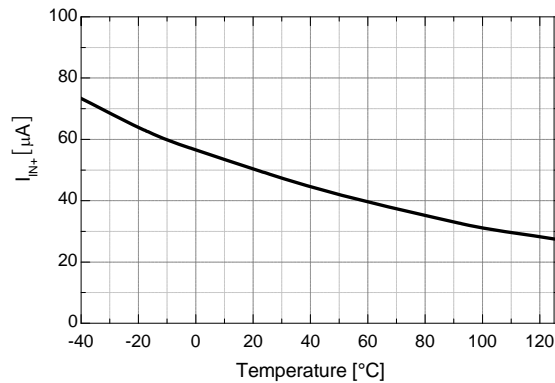

Figure 9. Logic Input High Bias Current vs. Temp.

Typical Characteristics (Continued)

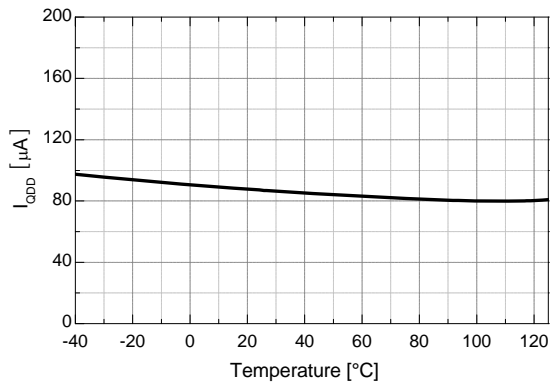

Figure 10. Quiescent V_{DD} Supply Current vs. Temp.

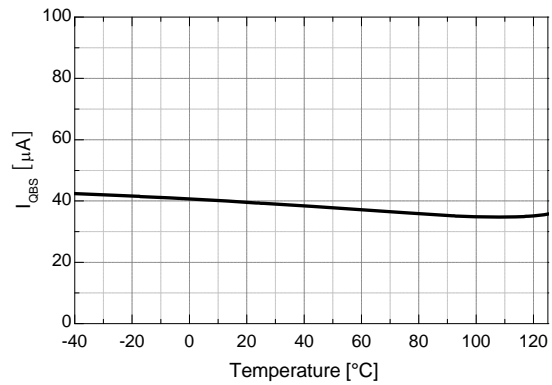

Figure 11. Quiescent V_{BS} Supply Current vs. Temp.

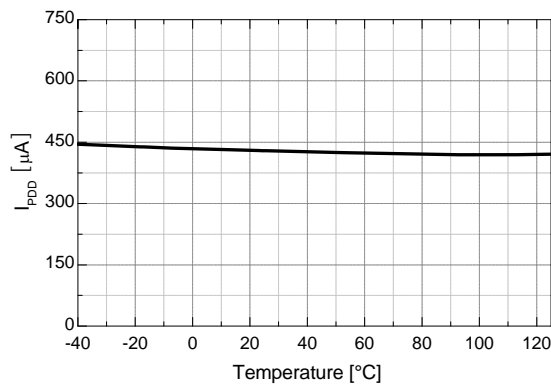

Figure 12. Operating V_{DD} Supply Current vs. Temp.

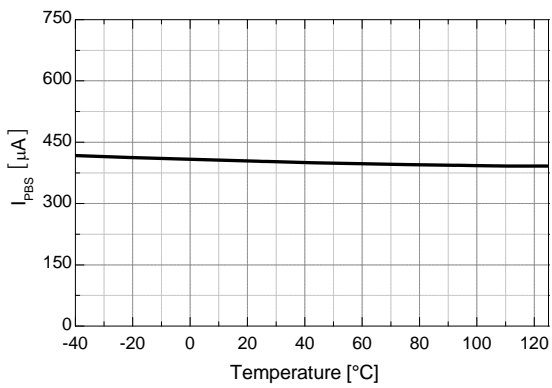

Figure 13. Operating V_{BS} Supply Current vs. Temp.

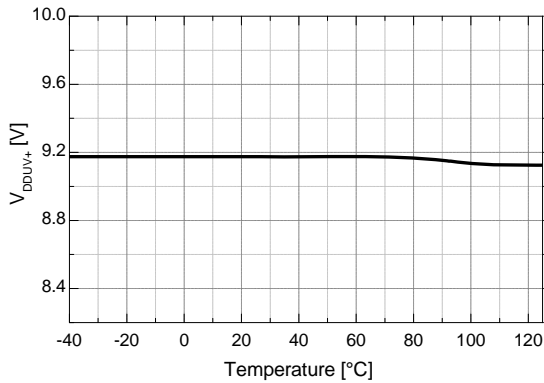

Figure 14. V_{DD} UVLO+ vs. Temp.

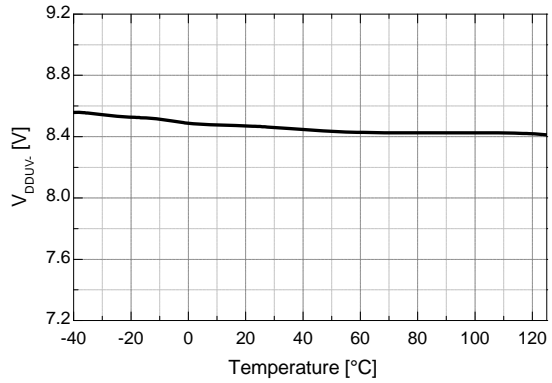

Figure 15. V_{DD} UVLO- vs. Temp.

Typical Characteristics (Continued)

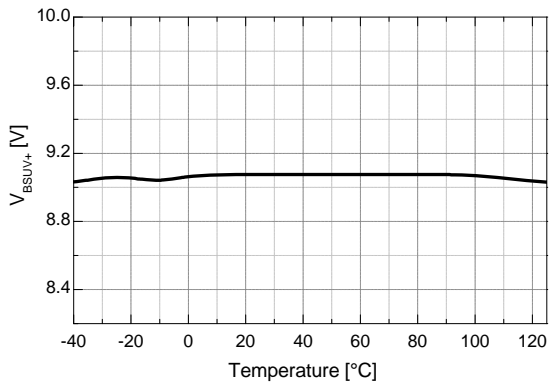

Figure 16. V_{BS} UVLO+ vs. Temp.

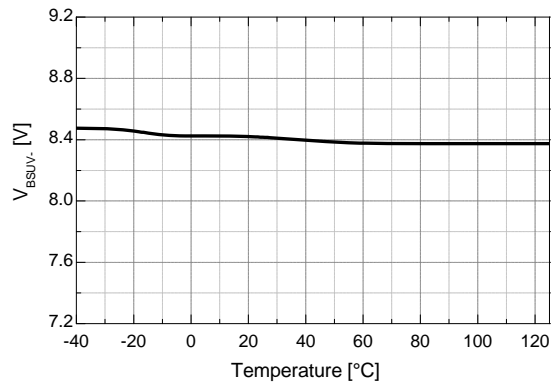

Figure 17. V_{BS} UVLO- vs. Temp.

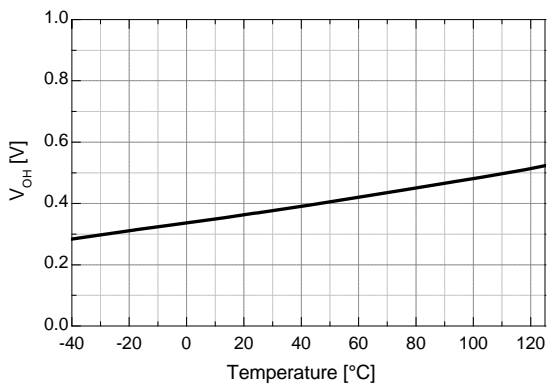

Figure 18. High-Level Output Voltage vs. Temp.

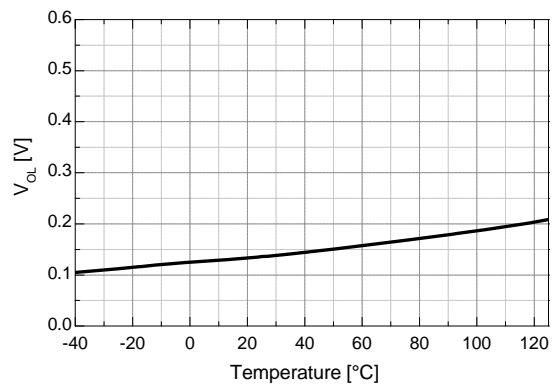

Figure 19. Low-Level Output Voltage vs. Temp.

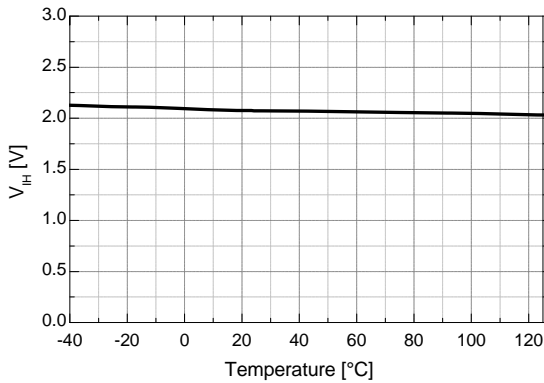

Figure 20. Logic High Input Voltage vs. Temp.

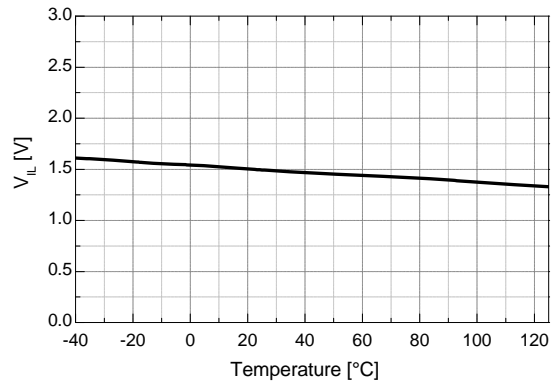

Figure 21. Logic Low Input Voltage vs. Temp.

Typical Characteristics (Continued)

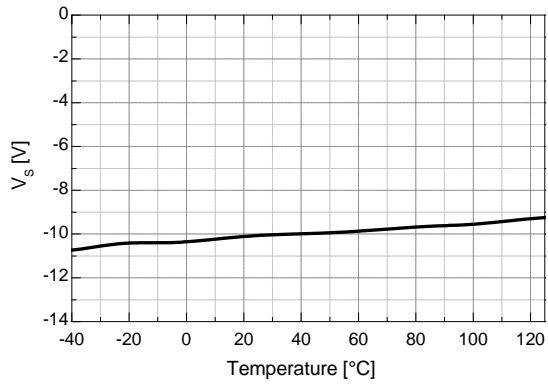

Figure 22. Allowable Negative V_S Voltage vs. Temp.



Application Information

1. Protection Function

1.1 Under-Voltage Lockout (UVLO)

The high- and low-side drivers include under-voltage lockout (UVLO) protection circuitry for each channel that monitors the supply voltage (V_{DD}) and bootstrap capacitor voltage (V_{BS}) independently. It can be designed prevent malfunction when V_{DD} and V_{BS} are lower than the specified threshold voltage. The UVLO hysteresis prevent chattering during power supply transitions.

1.2 Shoot-Through Prevention Function

The FAN73833 has shoot-through prevention circuitry monitoring the high- and low-side control inputs. It can be designed to prevent outputs of high and low side from turning on at same time, as shown Figure 23 and 28.

2. Switching Time Definitions

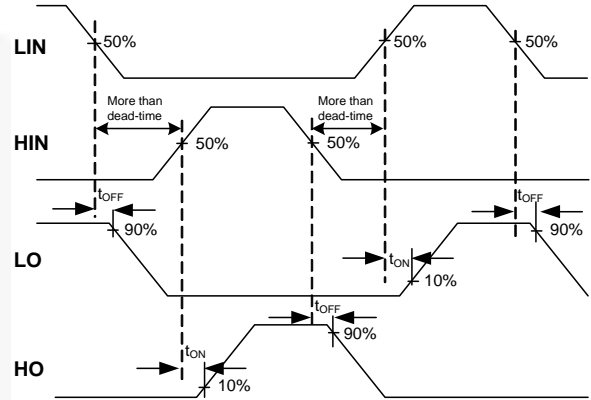

Figure 25. Switching Time Definition

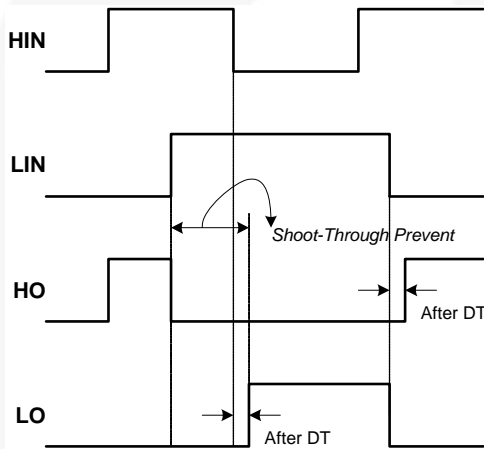

Figure 23. Waveforms for Shoot-Through Prevention

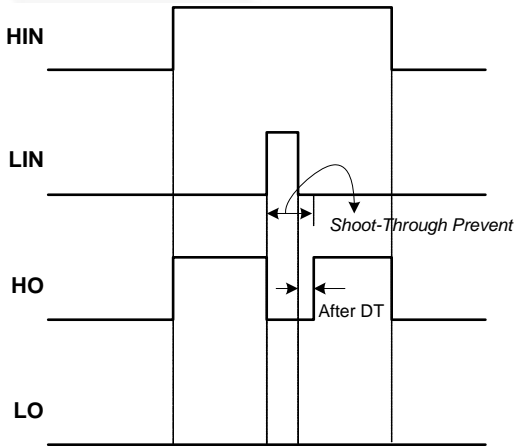

Figure 24. Waveforms for Shoot-Through Prevention

Mechanical Dimensions

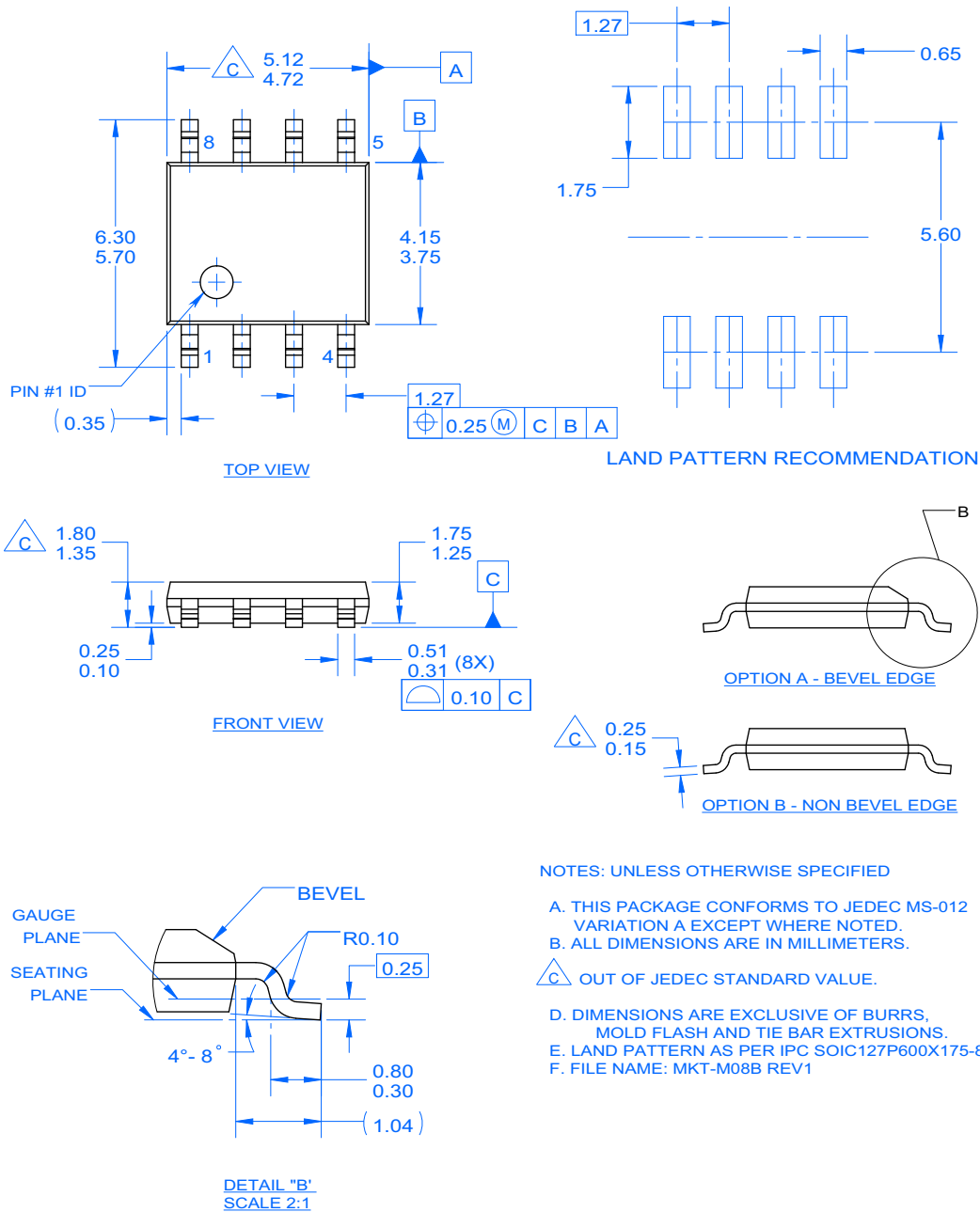

Figure 26. 8-Lead, Small Outline Package (SOP)

Package drawings are provided as a service to customers considering Fairchild components. Drawings may change in any manner without notice. Please note the revision and/or date on the drawing and contact a Fairchild Semiconductor representative to verify or obtain the most recent revision. Package specifications do not expand the terms of Fairchild's worldwide terms and conditions, specifically the warranty therein, which covers Fairchild products.

Always visit Fairchild Semiconductor's online packaging area for the most recent package drawings:

<http://www.fairchildsemi.com/packaging/>



TRADEMARKS

The following includes registered and unregistered trademarks and service marks, owned by Fairchild Semiconductor and/or its global subsidiaries, and is not intended to be an exhaustive list of all such trademarks.

- | | | | |
|--|--|--|---|
| 2Cool™ | F-PFST™ | PowerTrench® | The Power Franchise® |
| AccuPower™ | FRFET® | PowerXS™ | the power franchise |
| AX-CAP™* | Global Power Resource™ | Programmable Active Droop™ | TinyBoost™ |
| BitSiC™ | GreenBridge™ | QFET® | TinyBuck™ |
| Build it Now™ | Green FPS™ | QS™ | TinyCalc™ |
| CorePLUS™ | Green FPS™ e-Series™ | Quiet Series™ | TinyLogic® |
| CorePOWER™ | Gmax™ | RapidConfigure™ | TINYOPTO™ |
| CROSS VOLT™ | GTO™ |  ™ | TinyPower™ |
| CTL™ | IntelliMAX™ | Saving our world, 1mW/W/kW at a time™ | TinyPWM™ |
| Current Transfer Logic™ | ISOPLANAR™ | SignalWise™ | TinyWire™ |
| DEUXPEED® | Making Small Speakers Sound Louder and Better™ | SmartMax™ | TranSiC™ |
| Dual Cool™ | MegaBuck™ | SMART START™ | TriFault Detect™ |
| EcoSPARK® | MICROCOUPLER™ | Solutions for Your Success™ | TRUECURRENT®* |
| EfficientMax™ | MicroFET™ | SPM® | µSerDes™ |
| ESBC™ | MicroPak™ | STEALTH™ |  ™ |
|  Fairchild® | MicroPak2™ | SuperFET® | UHC® |
| Fairchild Semiconductor® | MillerDrive™ | SuperSOT™-3 | Ultra FRFET™ |
| FACT Quiet Series™ | MotionMax™ | SuperSOT™-6 | UniFET™ |
| FACT® | mWSaver™ | SuperSOT™-8 | VCS™ |
| FAST® | OptoHi™ | SupreMOS® | VisualMax™ |
| FastvCore™ | OPTOLOGIC® | SyncFET™ | VoltagePlus™ |
| FETBench™ | OPTOPLANAR® | Sync-Lock™ | XS™ |
| FlashWriter®* | |  SYSTEM GENERAL®* | |
| FPS™ | | | |

* Trademarks of System General Corporation, used under license by Fairchild Semiconductor.

DISCLAIMER

FAIRCHILD SEMICONDUCTOR RESERVES THE RIGHT TO MAKE CHANGES WITHOUT FURTHER NOTICE TO ANY PRODUCTS HEREIN TO IMPROVE RELIABILITY, FUNCTION, OR DESIGN. FAIRCHILD DOES NOT ASSUME ANY LIABILITY ARISING OUT OF THE APPLICATION OR USE OF ANY PRODUCT OR CIRCUIT DESCRIBED HEREIN; NEITHER DOES IT CONVEY ANY LICENSE UNDER ITS PATENT RIGHTS, NOR THE RIGHTS OF OTHERS. THESE SPECIFICATIONS DO NOT EXPAND THE TERMS OF FAIRCHILD'S WORLDWIDE TERMS AND CONDITIONS, SPECIFICALLY THE WARRANTY THEREIN, WHICH COVERS THESE PRODUCTS.

LIFE SUPPORT POLICY

FAIRCHILD'S PRODUCTS ARE NOT AUTHORIZED FOR USE AS CRITICAL COMPONENTS IN LIFE SUPPORT DEVICES OR SYSTEMS WITHOUT THE EXPRESS WRITTEN APPROVAL OF FAIRCHILD SEMICONDUCTOR CORPORATION.

As used herein:

1. Life support devices or systems are devices or systems which, (a) are intended for surgical implant into the body or (b) support or sustain life, and (c) whose failure to perform when properly used in accordance with instructions for use provided in the labeling, can be reasonably expected to result in a significant injury of the user.
2. A critical component in any component of a life support, device, or system whose failure to perform can be reasonably expected to cause the failure of the life support device or system, or to affect its safety or effectiveness.

ANTI-COUNTERFEITING POLICY

Fairchild Semiconductor Corporation's Anti-Counterfeiting Policy. Fairchild's Anti-Counterfeiting Policy is also stated on our external website, www.fairchildsemi.com, under Sales Support.

Counterfeiting of semiconductor parts is a growing problem in the industry. All manufacturers of semiconductor products are experiencing counterfeiting of their parts. Customers who inadvertently purchase counterfeit parts experience many problems such as loss of brand reputation, substandard performance, failed applications, and increased cost of production and manufacturing delays. Fairchild is taking strong measures to protect ourselves and our customers from the proliferation of counterfeit parts. Fairchild strongly encourages customers to purchase Fairchild parts either directly from Fairchild or from Authorized Fairchild Distributors who are listed by country on our web page cited above. Products customers buy either from Fairchild directly or from Authorized Fairchild Distributors are genuine parts, have full traceability, meet Fairchild's quality standards for handling and storage and provide access to Fairchild's full range of up-to-date technical and product information. Fairchild and our Authorized Distributors will stand behind all warranties and will appropriately address any warranty issues that may arise. Fairchild will not provide any warranty coverage or other assistance for parts bought from Unauthorized Sources. Fairchild is committed to combat this global problem and encourage our customers to do their part in stopping this practice by buying direct or from authorized distributors.

PRODUCT STATUS DEFINITIONS

Definition of Terms

Datasheet Identification	Product Status	Definition
Advance Information	Formative / In Design	Datasheet contains the design specifications for product development. Specifications may change in any manner without notice.
Preliminary	First Production	Datasheet contains preliminary data; supplementary data will be published at a later date. Fairchild Semiconductor reserves the right to make changes at any time without notice to improve design.
No Identification Needed	Full Production	Datasheet contains final specifications. Fairchild Semiconductor reserves the right to make changes at any time without notice to improve the design.
Obsolete	Not In Production	Datasheet contains specifications on a product that is discontinued by Fairchild Semiconductor. The datasheet is for reference information only.

Rev. 162

ON Semiconductor and  are trademarks of Semiconductor Components Industries, LLC dba ON Semiconductor or its subsidiaries in the United States and/or other countries. ON Semiconductor owns the rights to a number of patents, trademarks, copyrights, trade secrets, and other intellectual property. A listing of ON Semiconductor's product/patent coverage may be accessed at www.onsemi.com/site/pdf/Patent-Marking.pdf. ON Semiconductor reserves the right to make changes without further notice to any products herein. ON Semiconductor makes no warranty, representation or guarantee regarding the suitability of its products for any particular purpose, nor does ON Semiconductor assume any liability arising out of the application or use of any product or circuit, and specifically disclaims any and all liability, including without limitation special, consequential or incidental damages. Buyer is responsible for its products and applications using ON Semiconductor products, including compliance with all laws, regulations and safety requirements or standards, regardless of any support or applications information provided by ON Semiconductor. "Typical" parameters which may be provided in ON Semiconductor data sheets and/or specifications can and do vary in different applications and actual performance may vary over time. All operating parameters, including "Typicals" must be validated for each customer application by customer's technical experts. ON Semiconductor does not convey any license under its patent rights nor the rights of others. ON Semiconductor products are not designed, intended, or authorized for use as a critical component in life support systems or any FDA Class 3 medical devices or medical devices with a same or similar classification in a foreign jurisdiction or any devices intended for implantation in the human body. Should Buyer purchase or use ON Semiconductor products for any such unintended or unauthorized application, Buyer shall indemnify and hold ON Semiconductor and its officers, employees, subsidiaries, affiliates, and distributors harmless against all claims, costs, damages, and expenses, and reasonable attorney fees arising out of, directly or indirectly, any claim of personal injury or death associated with such unintended or unauthorized use, even if such claim alleges that ON Semiconductor was negligent regarding the design or manufacture of the part. ON Semiconductor is an Equal Opportunity/Affirmative Action Employer. This literature is subject to all applicable copyright laws and is not for resale in any manner.

PUBLICATION ORDERING INFORMATION

LITERATURE FULFILLMENT:

Literature Distribution Center for ON Semiconductor
19521 E. 32nd Pkwy, Aurora, Colorado 80011 USA
Phone: 303-675-2175 or 800-344-3860 Toll Free USA/Canada
Fax: 303-675-2176 or 800-344-3867 Toll Free USA/Canada
Email: orderlit@onsemi.com

N. American Technical Support: 800-282-9855 Toll Free
USA/Canada
Europe, Middle East and Africa Technical Support:
Phone: 421 33 790 2910
Japan Customer Focus Center
Phone: 81-3-5817-1050

ON Semiconductor Website: www.onsemi.com
Order Literature: <http://www.onsemi.com/orderlit>
For additional information, please contact your local
Sales Representative