

Dual N-Channel 20-V (D-S) MOSFET with Schottky Diode

PRODUCT SUMMARY				
	V _{DS} (V)	R _{DS(on)} (Ω)	I _D (A) ^a	Q _g (Typ.)
Channel-1	20	0.0094 at V _{GS} = 10 V	14.1	9.6
		0.0125 at V _{GS} = 4.5 V	12.2	
Channel-2	20	0.008 at V _{GS} = 10 V	20	14.1
		0.0095 at V _{GS} = 4.5 V	18.9	

SCHOTTKY PRODUCT SUMMARY		
V _{DS} (V)	V _{SD} (V) Diode Forward Voltage	I _F (A)
20	0.55 V at 2.5 A	2

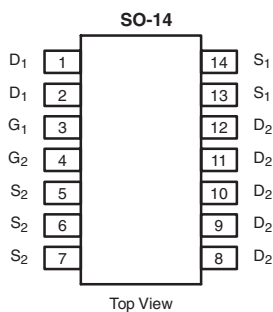

Ordering Information: Si4340CDY-T1-E3 (Lead (Pb)-free)
Si4340CDY-T1-GE3 (Lead (Pb)-free and Halogen-free)

FEATURES

- Halogen-free According to IEC 61249-2-21 Definition
- TrenchFET[®] Power MOSFET
- 100 % R_g Tested
- 100 % UIS Tested
- Compliant to RoHS Directive 2002/95/EC



RoHS
COMPLIANT
HALOGEN
FREE
Available

APPLICATIONS

- DC/DC Converters
 - Game Stations
 - Notebook PC Logic

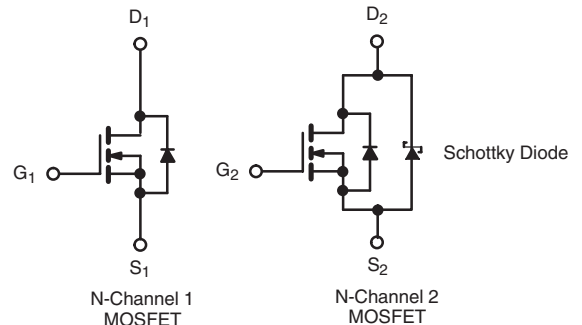

ABSOLUTE MAXIMUM RATINGS T _A = 25 °C, unless otherwise noted					
Parameter	Symbol	Channel-1	Channel-2	Unit	
Drain-Source Voltage	V _{DS}	20	20	V	
Gate-Source Voltage	V _{GS}	± 20	± 16		
Continuous Drain Current (T _J = 150 °C)	I _D	T _C = 25 °C	14.1	20	A
		T _C = 70 °C	11.2	16.5	
		T _A = 25 °C	11.5 ^{b, c}	15.2 ^{b, c}	
		T _A = 70 °C	9.2 ^{b, c}	12.2 ^{b, c}	
Pulsed Drain Current	I _{DM}	40	50	A	
Source-Drain Current Diode Current	I _S	T _C = 25 °C	2.5		4.5
		T _A = 25 °C	1.7 ^{b, c}	2.5 ^{b, c}	
Single Pulse Avalanche Current	I _{AS}	5		mJ	
Single Pulse Avalanche Energy	E _{AS}	1.25			
Maximum Power Dissipation	P _D	T _C = 25 °C	3	5.4	W
		T _C = 70 °C	1.9	3.5	
		T _A = 25 °C	2 ^{b, c}	3 ^{b, c}	
		T _A = 70 °C	1.3 ^{b, c}	1.9 ^{b, c}	
Operating Junction and Storage Temperature Range	T _J , T _{stg}	- 55 to 150		°C	

THERMAL RESISTANCE RATINGS							
Parameter	Symbol	Channel-1		Channel-2		Unit	
		Typ.	Max.	Typ.	Max.		
Maximum Junction-to-Ambient ^{b, d}	R _{thJA}	53	62.5	35	42	°C/W	
Maximum Junction-to-Foot (Drain)	R _{thJF}	35	42	18	23		

Notes:

- Based on T_C = 25 °C.
- Surface Mounted on 1" x 1" FR4 board.
- t = 10 s.
- Maximum under Steady State conditions for channel 1 is 110 °C/W and channel 2 is 87 °C/W.

SPECIFICATIONS $T_J = 25\text{ }^\circ\text{C}$, unless otherwise noted							
Parameter	Symbol	Test Conditions	Min.	Typ.	Max.	Unit	
Static							
Drain-Source Breakdown Voltage	V_{DS}	$V_{GS} = 0\text{ V}, I_D = 250\text{ }\mu\text{A}$	Ch-1	20			V
		$V_{GS} = 0\text{ V}, I_D = 250\text{ }\mu\text{A}$	Ch-2	20			
V_{DS} Temperature Coefficient	$\Delta V_{DS}/T_J$	$I_D = 250\text{ }\mu\text{A}$	Ch-1		20		mV/ $^\circ\text{C}$
		$I_D = 25\text{ mA}$	Ch-2		22		
$V_{GS(th)}$ Temperature Coefficient	$\Delta V_{GS(th)}/T_J$	$I_D = 250\text{ }\mu\text{A}$	Ch-1		- 5.5		
		$I_D = 25\text{ mA}$	Ch-2		- 2.5		
Gate Threshold Voltage	$V_{GS(th)}$	$V_{DS} = V_{GS}, I_D = 250\text{ }\mu\text{A}$	Ch-1	1		3	V
		$V_{DS} = V_{GS}, I_D = 250\text{ }\mu\text{A}$	Ch-2	0.8		2.2	
Gate-Body Leakage	I_{GSS}	$V_{DS} = 0\text{ V}, V_{GS} = \pm 20\text{ V}$	Ch-1			100	nA
		$V_{DS} = 0\text{ V}, V_{GS} = \pm 16\text{ V}$	Ch-2			100	
Zero Gate Voltage Drain Current	I_{DSS}	$V_{DS} = 20\text{ V}, V_{GS} = 0\text{ V}$	Ch-1			1	μA
		$V_{DS} = 20\text{ V}, V_{GS} = 0\text{ V}$	Ch-2			100	
		$V_{DS} = 20\text{ V}, V_{GS} = 0\text{ V}, T_J = 85\text{ }^\circ\text{C}$	Ch-1			15	
		$V_{DS} = 20\text{ V}, V_{GS} = 0\text{ V}, T_J = 85\text{ }^\circ\text{C}$	Ch-2			10 000	
On-State Drain Current ^b	$I_{D(on)}$	$V_{DS} \geq 5\text{ V}, V_{GS} = 10\text{ V}$	Ch-1	20			A
		$V_{DS} \geq 5\text{ V}, V_{GS} = 10\text{ V}$	Ch-2	30			
Drain-Source On-State Resistance ^b	$R_{DS(on)}$	$V_{GS} = 10\text{ V}, I_D = 11.5\text{ A}$	Ch-1		0.0077	0.0094	Ω
		$V_{GS} = 10\text{ V}, I_D = 15.2\text{ A}$	Ch-2		0.0065	0.008	
		$V_{GS} = 4.5\text{ V}, I_D = 10\text{ A}$	Ch-1		0.010	0.0125	
		$V_{GS} = 4.5\text{ V}, I_D = 14\text{ A}$	Ch-2		0.0075	0.0095	
Forward Transconductance ^b	g_{fs}	$V_{DS} = 10\text{ V}, I_D = 11.5\text{ A}$	Ch-1		45		S
		$V_{DS} = 10\text{ V}, I_D = 15.2\text{ A}$	Ch-2		73		
Dynamic^a							
Input Capacitance	C_{iss}	Channel-1 $V_{DS} = 10\text{ V}, V_{GS} = 0\text{ V}, f = 1\text{ MHz}$	Ch-1		1300		μF
Output Capacitance	C_{oss}		Ch-2		1900		
Reverse Transfer Capacitance	C_{rss}	Channel-2 $V_{DS} = 10\text{ V}, V_{GS} = 0\text{ V}, f = 1\text{ MHz}$	Ch-1		330		μF
			Ch-2		500		
Total Gate Charge	Q_g	$V_{DS} = 10\text{ V}, V_{GS} = 10\text{ V}, I_D = 11.5\text{ A}$	Ch-1		150		nC
			Ch-2		160		
		$V_{DS} = 10\text{ V}, V_{GS} = 10\text{ V}, I_D = 15.2\text{ A}$	Ch-1		21	32	
			Ch-2		31	47	
Gate-Source Charge	Q_{gs}	Channel-1 $V_{DS} = 10\text{ V}, V_{GS} = 4.5\text{ V}, I_D = 11.5\text{ A}$	Ch-1		9.6	15	
			Ch-2		14.1	22	
Gate-Drain Charge	Q_{gd}	Channel-2 $V_{DS} = 10\text{ V}, V_{GS} = 4.5\text{ V}, I_D = 15.2\text{ A}$	Ch-1		4		
			Ch-2		5		
Gate Resistance	R_g	$f = 1\text{ MHz}$	Ch-1		0.65	1.2	Ω
			Ch-2		1.4	2.8	

Notes:

- a. Guaranteed by design, not subject to production testing.
b. Pulse test; pulse width $\leq 300\text{ }\mu\text{s}$, duty cycle $\leq 2\%$.



SPECIFICATIONS $T_J = 25\text{ }^\circ\text{C}$, unless otherwise noted							
Parameter	Symbol	Test Conditions	Min.	Typ.	Max.	Unit	
Dynamic^a							
Turn-On Delay Time	$t_{d(on)}$	Channel-1 $V_{DD} = 10\text{ V}$, $R_L = 1.1\ \Omega$ $I_D \cong 9.2\text{ A}$, $V_{GEN} = 4.5\text{ V}$, $R_g = 1\ \Omega$	Ch-1		20	30	ns
Rise Time	t_r		Ch-2		22	35	
Turn-Off Delay Time	$t_{d(off)}$	Channel-2 $V_{DD} = 10\text{ V}$, $R_L = 1\ \Omega$ $I_D \cong 10\text{ A}$, $V_{GEN} = 4.5\text{ V}$, $R_g = 1\ \Omega$	Ch-1		20	30	
			Ch-2		32	50	
Fall Time	t_f		Ch-1		10	15	
			Ch-2		10	15	
Turn-On Delay Time	$t_{d(on)}$	Channel-1 $V_{DD} = 10\text{ V}$, $R_L = 1.1\ \Omega$ $I_D \cong 9.2\text{ A}$, $V_{GEN} = 10\text{ V}$, $R_g = 1\ \Omega$	Ch-1		10	15	
			Ch-2		10	15	
Rise Time	t_r		Ch-1		10	15	
			Ch-2		10	15	
Turn-Off Delay Time	$t_{d(off)}$	Channel-2 $V_{DD} = 10\text{ V}$, $R_L = 1\ \Omega$ $I_D \cong 10\text{ A}$, $V_{GEN} = 10\text{ V}$, $R_g = 1\ \Omega$	Ch-1		20	30	
			Ch-2		25	40	
Fall Time	t_f		Ch-1		10	15	
			Ch-2		10	15	
Drain-Source Body Diode Characteristics							
Continuous Source-Drain Diode Current	I_S	$T_C = 25\text{ }^\circ\text{C}$	Ch-1			2.5	A
			Ch-2			4.5	
Pulse Diode Forward Current ^a	I_{SM}		Ch-1			40	
			Ch-2			50	
Body Diode Voltage	V_{SD}	$I_S = 9.2\text{ A}$	Ch-1		0.8	1.2	V
		$I_S = 2.5\text{ A}$	Ch-2		0.45	0.55	
Body Diode Reverse Recovery Time	t_{rr}	Channel-1 $I_F = 9.2\text{ A}$, $di/dt = 100\text{ A}/\mu\text{s}$, $T_J = 25\text{ }^\circ\text{C}$	Ch-1		30	60	ns
			Ch-2		30	60	
Body Diode Reverse Recovery Charge	Q_{rr}	Channel-2 $I_F = 2.5\text{ A}$, $di/dt = 100\text{ A}/\mu\text{s}$, $T_J = 25\text{ }^\circ\text{C}$	Ch-1		15	25	nC
			Ch-2		20	30	
Reverse Recovery Fall Time	t_a		Ch-1		12		ns
			Ch-2		14		
Reverse Recovery Rise Time	t_b		Ch-1		18		
			Ch-2		16		

Notes:

- a. Guaranteed by design, not subject to production testing.
- b. Pulse test; pulse width $\leq 300\ \mu\text{s}$, duty cycle $\leq 2\%$.

Stresses beyond those listed under "Absolute Maximum Ratings" may cause permanent damage to the device. These are stress ratings only, and functional operation of the device at these or any other conditions beyond those indicated in the operational sections of the specifications is not implied. Exposure to absolute maximum rating conditions for extended periods may affect device reliability.

CHANNEL-1 TYPICAL CHARACTERISTICS 25 °C, unless otherwise noted

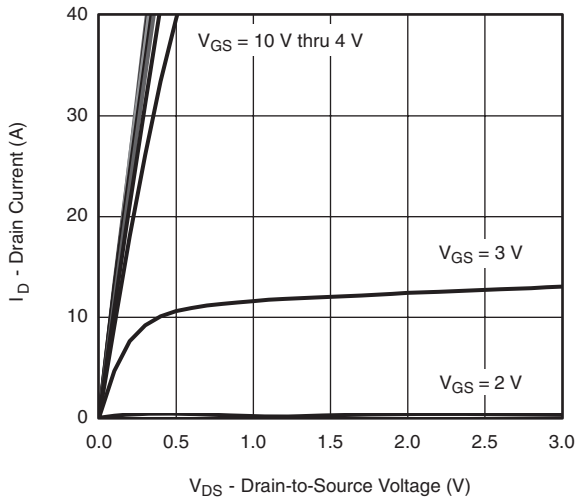

Output Characteristics

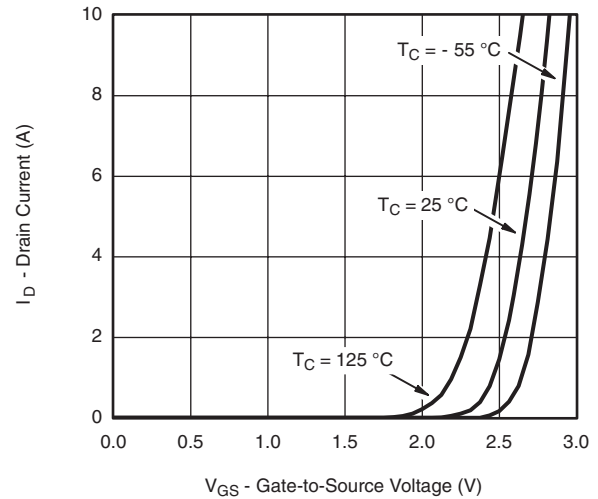

Transfer Characteristics

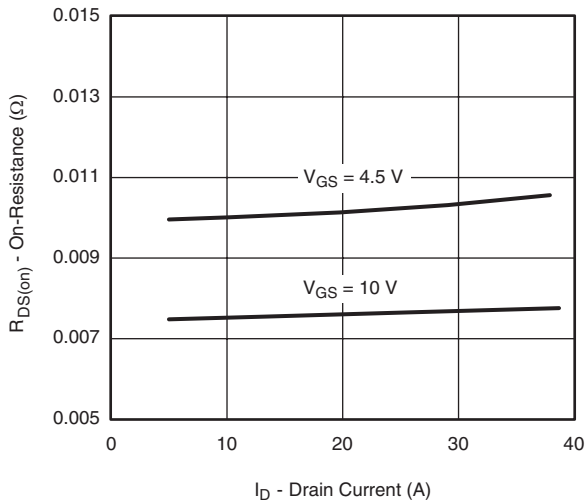

On-Resistance vs. Drain Current

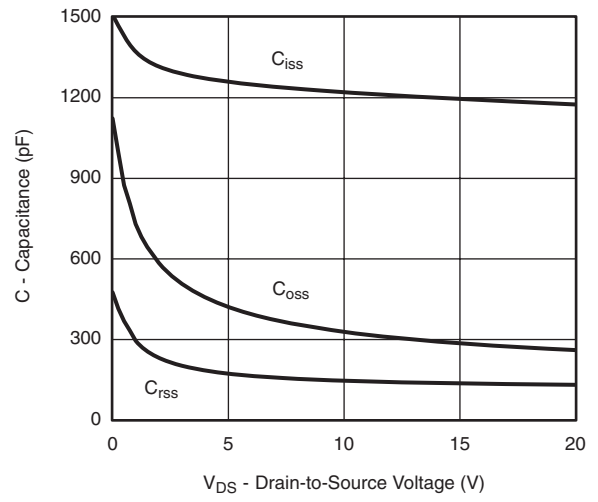

Capacitance

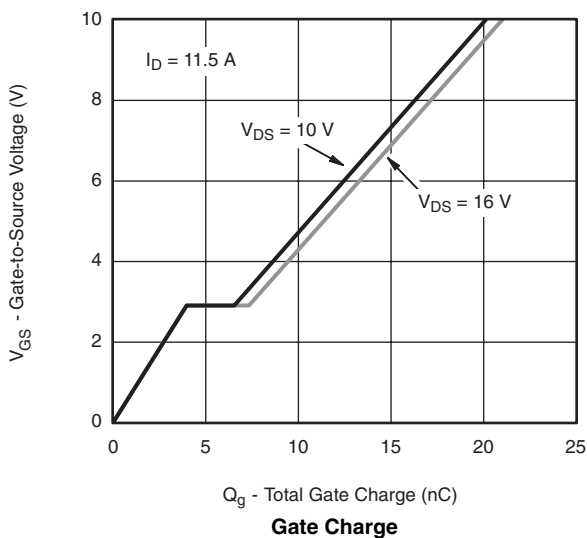

Gate Charge

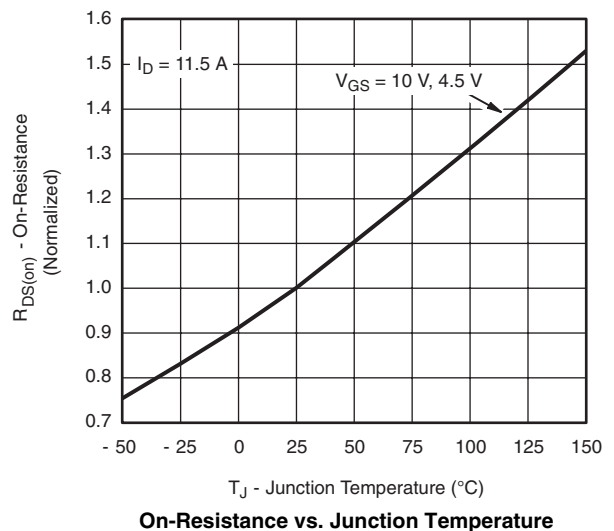

On-Resistance vs. Junction Temperature

CHANNEL-1 TYPICAL CHARACTERISTICS 25 °C, unless otherwise noted

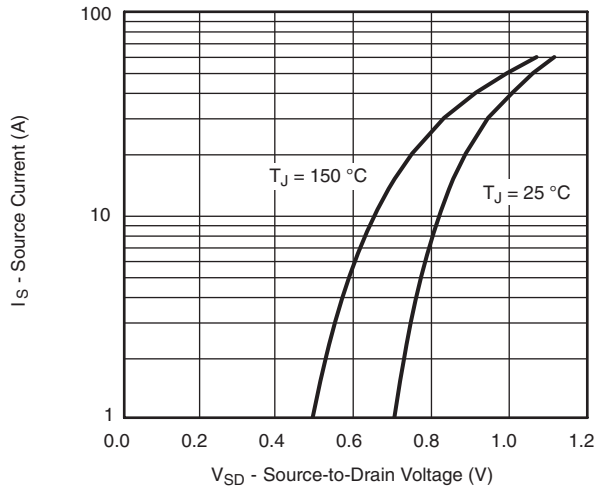

Source-Drain Diode Forward Voltage

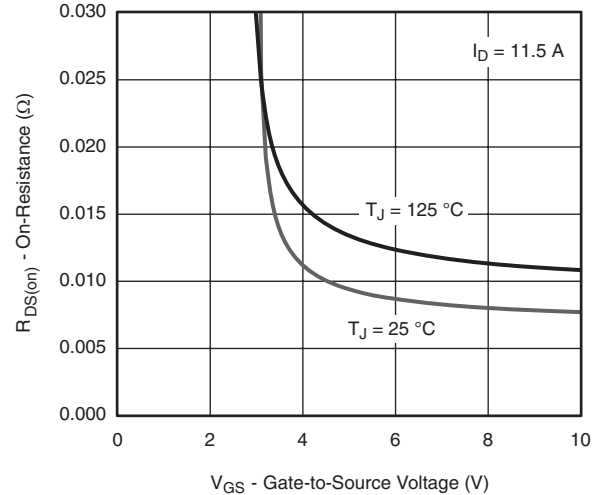

On-Resistance vs. Gate-to-Source Voltage

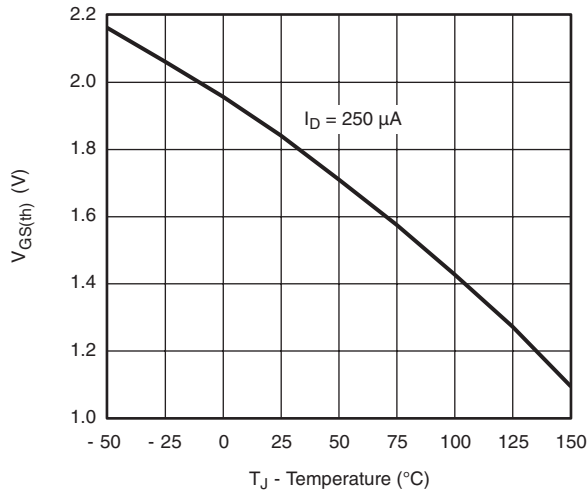

Threshold Voltage

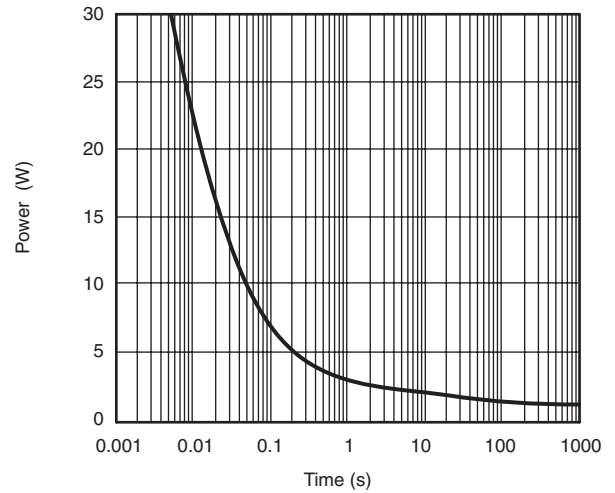

Single Pulse Power

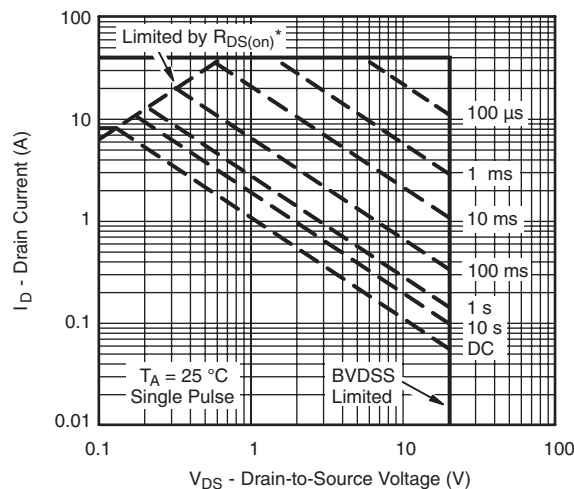

Safe Operating Area, Junction-to-Ambient
* $V_{GS} >$ minimum V_{GS} at which $R_{DS(on)}$ is specified

CHANNEL-1 TYPICAL CHARACTERISTICS 25 °C, unless otherwise noted

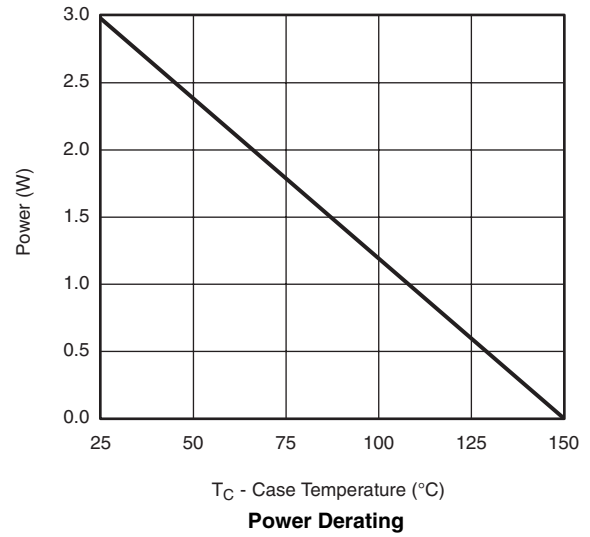
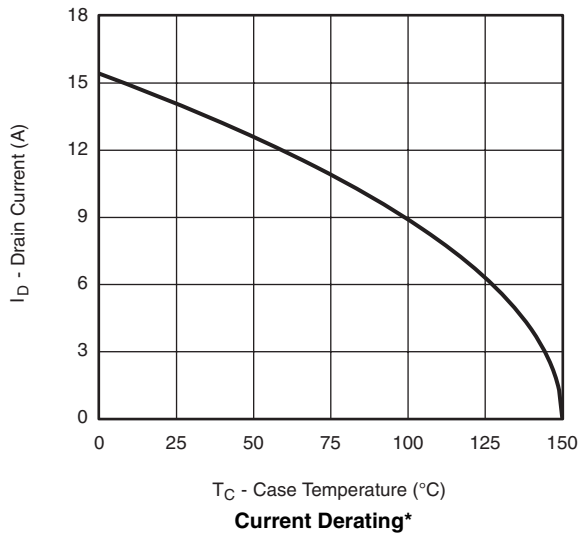

* The power dissipation P_D is based on $T_{J(max)} = 150$ °C, using junction-to-case thermal resistance, and is more useful in settling the upper dissipation limit for cases where additional heatsinking is used. It is used to determine the current rating, when this rating falls below the package limit.

CHANNEL-1 TYPICAL CHARACTERISTICS 25 °C, unless otherwise noted

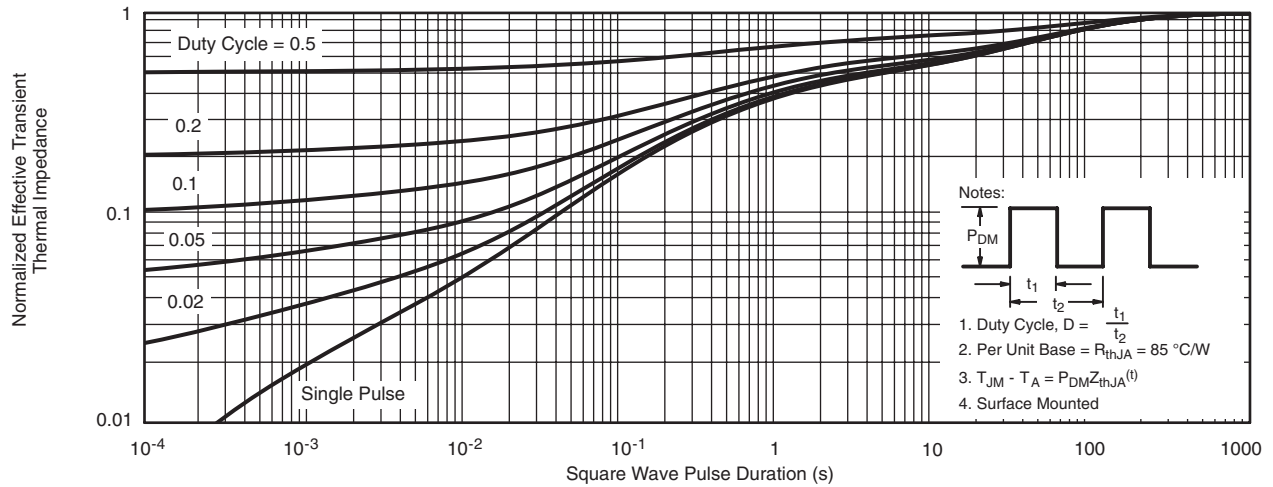

Normalized Thermal Transient Impedance, Junction-to-Ambient

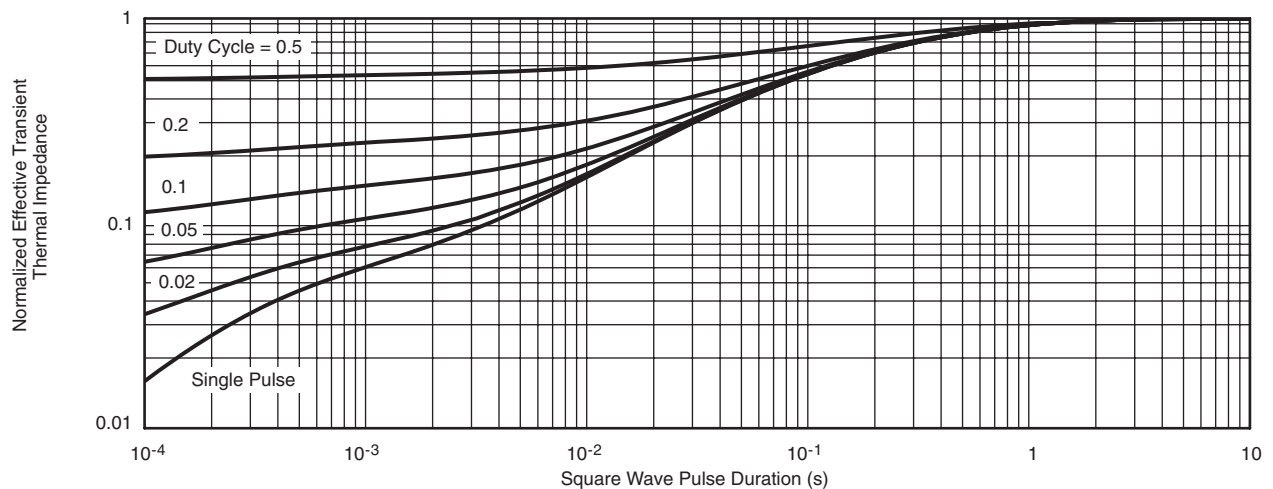

Normalized Thermal Transient Impedance, Junction-to-Foot

CHANNEL-2 TYPICAL CHARACTERISTICS 25 °C, unless otherwise noted

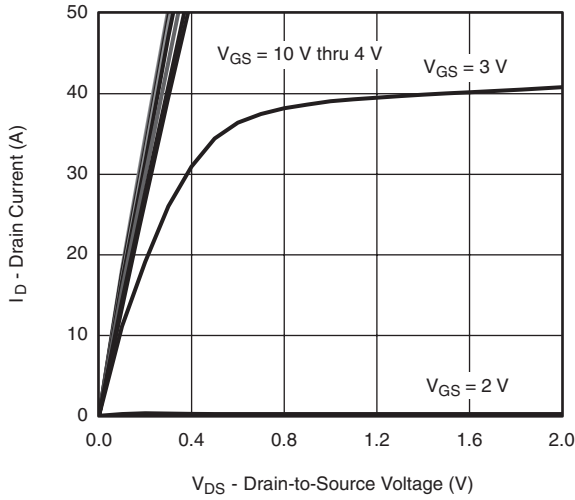

Output Characteristics

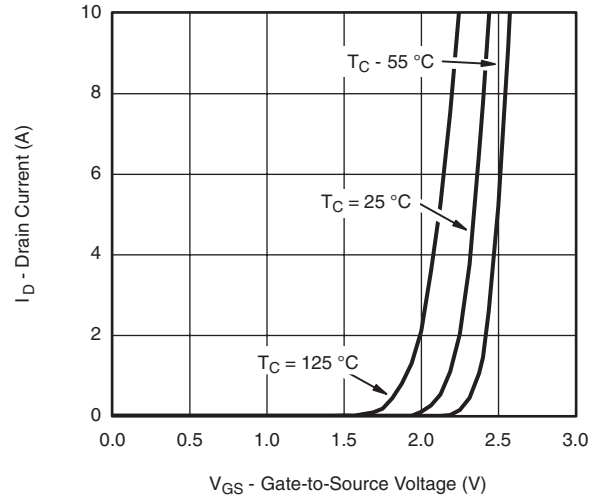

Transfer Characteristics

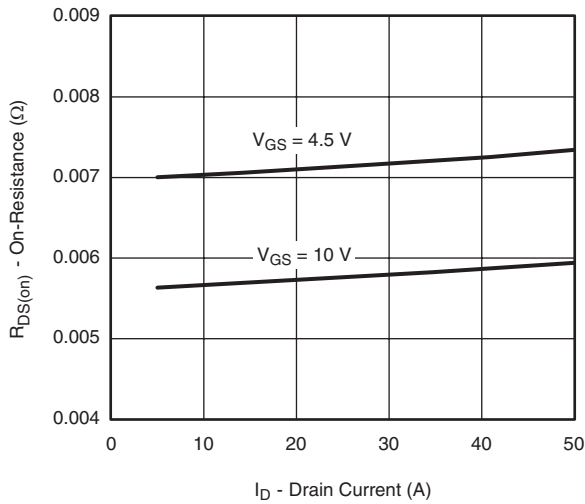

On-Resistance vs. Drain Current

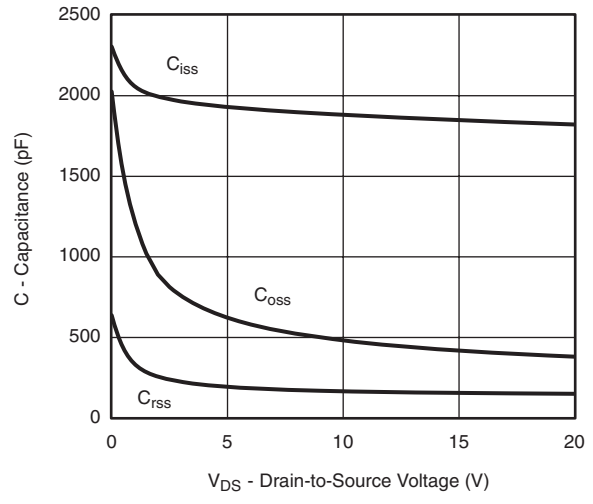

Capacitance

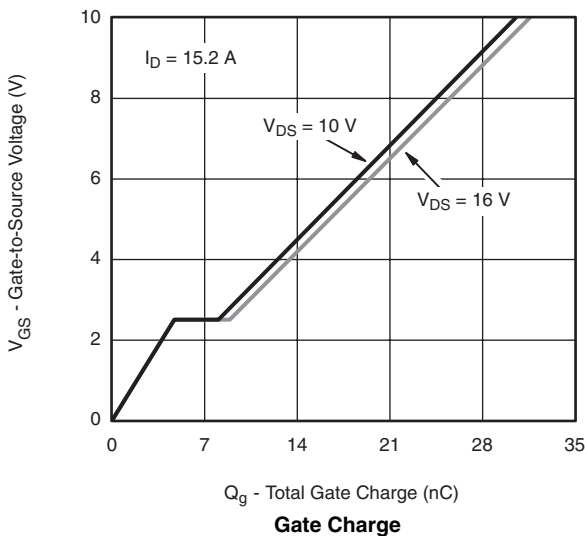

Gate Charge

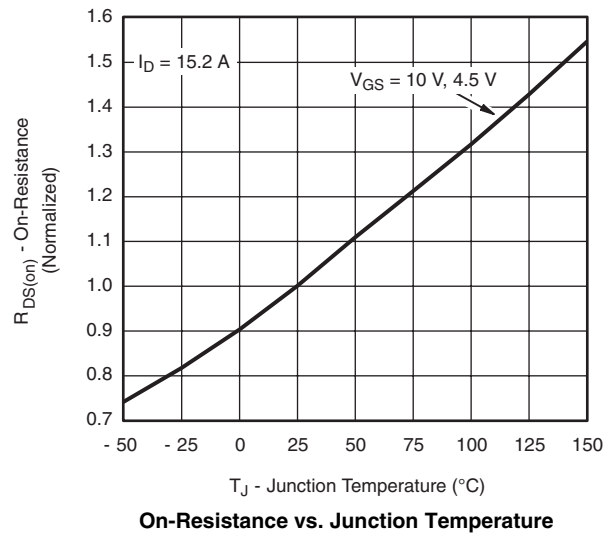

On-Resistance vs. Junction Temperature

CHANNEL-2 TYPICAL CHARACTERISTICS 25 °C, unless otherwise noted

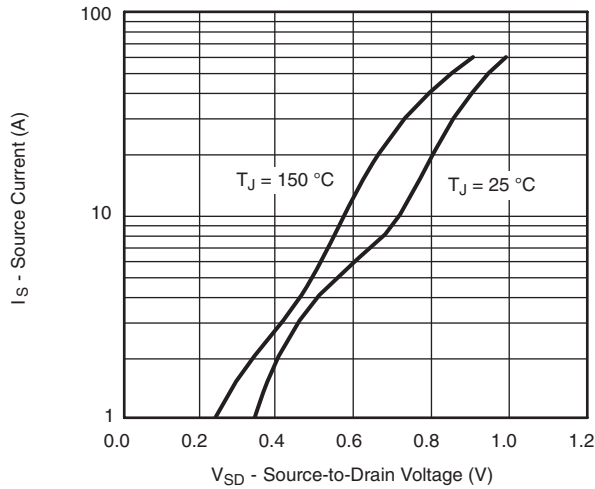

Source-Drain Diode Forward Voltage

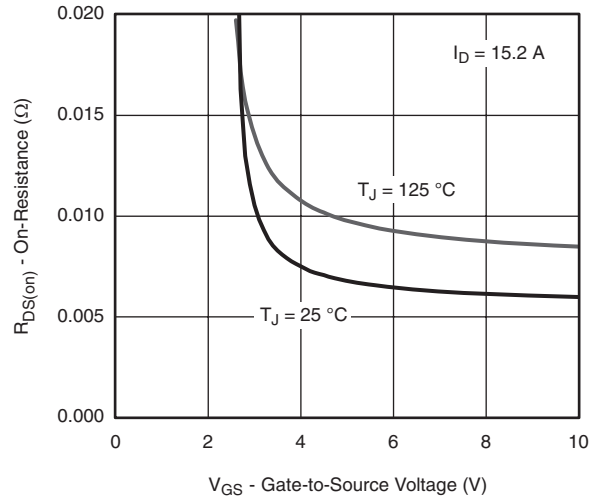

On-Resistance vs. Gate-to-Source Voltage

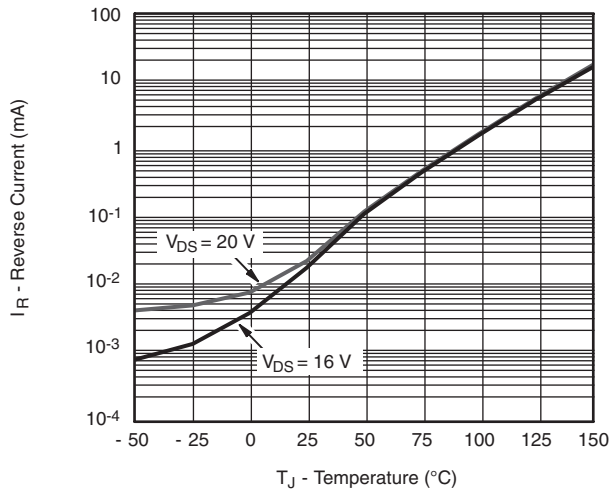

Reverse Current vs. Junction Temperature

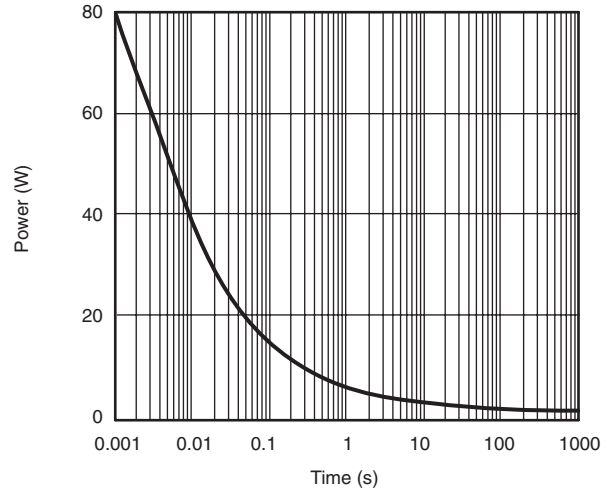

Single Pulse Power

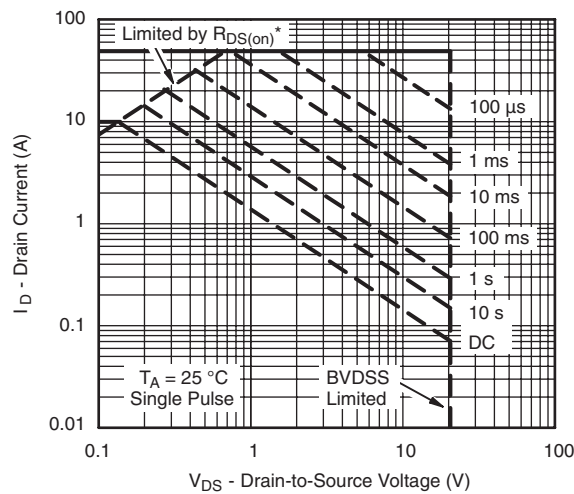

* $V_{GS} >$ minimum V_{GS} at which $R_{DS(on)}$ is specified

Safe Operating Area, Junction-to-Ambient

CHANNEL-2 TYPICAL CHARACTERISTICS 25 °C, unless otherwise noted

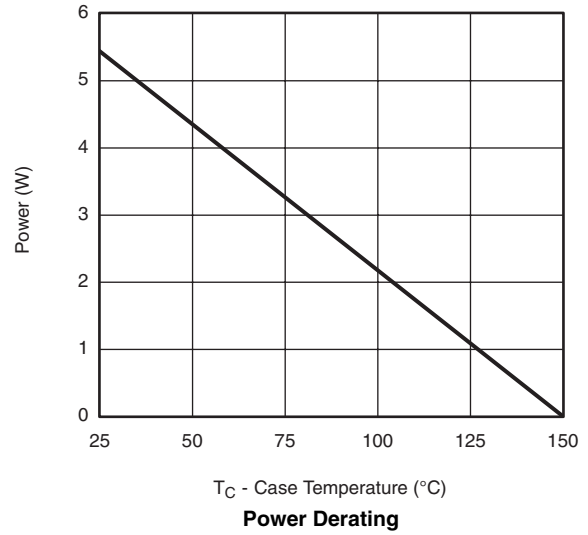
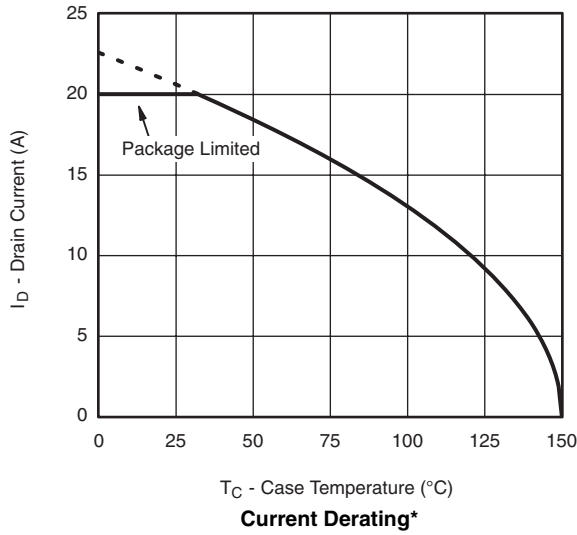

* The power dissipation P_D is based on $T_{J(max)} = 150$ °C, using junction-to-case thermal resistance, and is more useful in settling the upper dissipation limit for cases where additional heatsinking is used. It is used to determine the current rating, when this rating falls below the package limit.

CHANNEL-2 TYPICAL CHARACTERISTICS 25 °C, unless otherwise noted

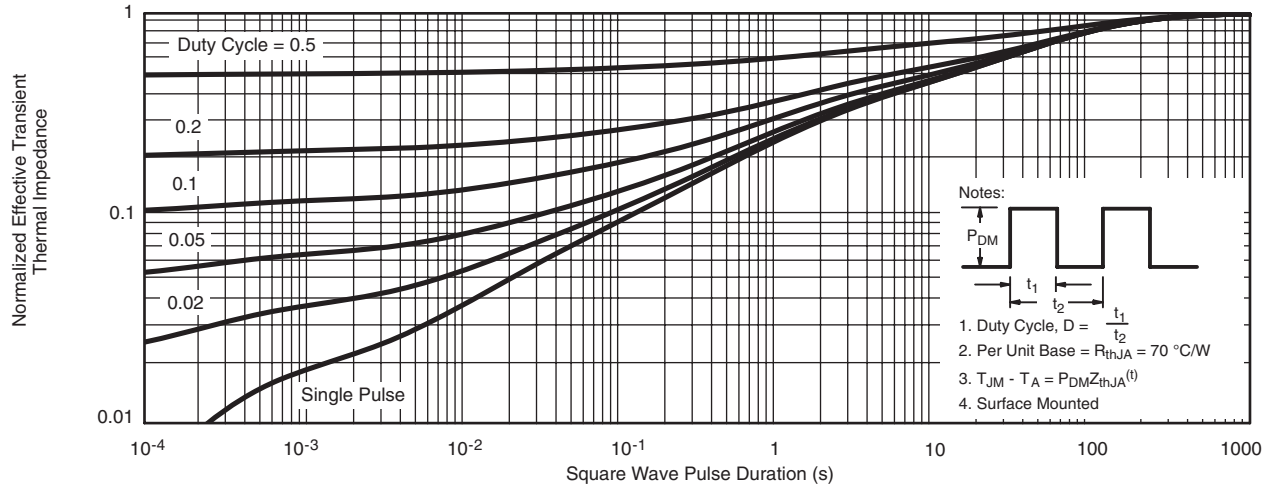

Normalized Thermal Transient Impedance, Junction-to-Ambient

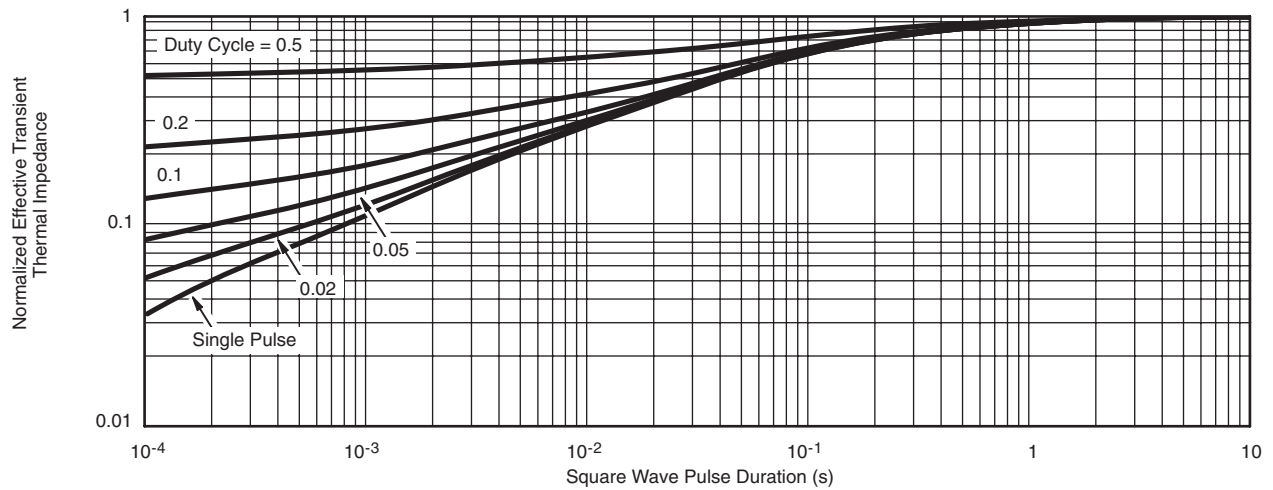

Normalized Thermal Transient Impedance, Junction-to-Foot

Vishay Siliconix maintains worldwide manufacturing capability. Products may be manufactured at one of several qualified locations. Reliability data for Silicon Technology and Package Reliability represent a composite of all qualified locations. For related documents such as package/tape drawings, part marking, and reliability data, see www.vishay.com/ppg?68398.



Disclaimer

ALL PRODUCT, PRODUCT SPECIFICATIONS AND DATA ARE SUBJECT TO CHANGE WITHOUT NOTICE TO IMPROVE RELIABILITY, FUNCTION OR DESIGN OR OTHERWISE.

Vishay Intertechnology, Inc., its affiliates, agents, and employees, and all persons acting on its or their behalf (collectively, "Vishay"), disclaim any and all liability for any errors, inaccuracies or incompleteness contained in any datasheet or in any other disclosure relating to any product.

Vishay makes no warranty, representation or guarantee regarding the suitability of the products for any particular purpose or the continuing production of any product. To the maximum extent permitted by applicable law, Vishay disclaims (i) any and all liability arising out of the application or use of any product, (ii) any and all liability, including without limitation special, consequential or incidental damages, and (iii) any and all implied warranties, including warranties of fitness for particular purpose, non-infringement and merchantability.

Statements regarding the suitability of products for certain types of applications are based on Vishay's knowledge of typical requirements that are often placed on Vishay products in generic applications. Such statements are not binding statements about the suitability of products for a particular application. It is the customer's responsibility to validate that a particular product with the properties described in the product specification is suitable for use in a particular application. Parameters provided in datasheets and / or specifications may vary in different applications and performance may vary over time. All operating parameters, including typical parameters, must be validated for each customer application by the customer's technical experts. Product specifications do not expand or otherwise modify Vishay's terms and conditions of purchase, including but not limited to the warranty expressed therein.

Hyperlinks included in this datasheet may direct users to third-party websites. These links are provided as a convenience and for informational purposes only. Inclusion of these hyperlinks does not constitute an endorsement or an approval by Vishay of any of the products, services or opinions of the corporation, organization or individual associated with the third-party website. Vishay disclaims any and all liability and bears no responsibility for the accuracy, legality or content of the third-party website or for that of subsequent links.

Except as expressly indicated in writing, Vishay products are not designed for use in medical, life-saving, or life-sustaining applications or for any other application in which the failure of the Vishay product could result in personal injury or death. Customers using or selling Vishay products not expressly indicated for use in such applications do so at their own risk. Please contact authorized Vishay personnel to obtain written terms and conditions regarding products designed for such applications.

No license, express or implied, by estoppel or otherwise, to any intellectual property rights is granted by this document or by any conduct of Vishay. Product names and markings noted herein may be trademarks of their respective owners.