

Optocoupler, Phototransistor Output, AC Input (Dual, Quad Channel)

Dual Channel

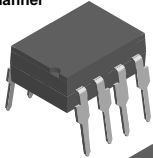

Quad Channel

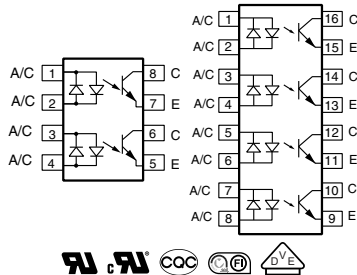
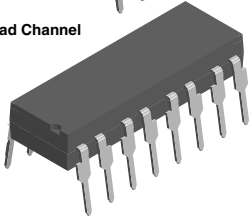

FEATURES

- Identical channel to channel footprint
- ILD620 crosses to TLP620-2
- ILQ620 crosses to TLP620-4
- High collector emitter voltage, $BV_{CEO} = 70\text{ V}$
- Dual and quad packages feature:
 - Reduced board space
 - Lower pin and parts count
 - Better channel to channel CTR match
 - Improved common mode rejection
- Isolation test voltage 5300 V_{RMS}
- Material categorization: For definitions of compliance please see www.vishay.com/doc?99912

RoHS
COMPLIANT

DESCRIPTION

The ILD620, ILQ620, ILD620GB, and ILQ620GB are multi-channel input phototransistor optocouplers that use inverse parallel GaAs IRLED emitter and high gain NPN silicon phototransistors per channel. These devices are constructed using over/under leadframe optical coupling and double molded insulation resulting in a withstand test voltage of 5300 V_{RMS} .

The LED parameters and the linear CTR characteristics make these devices well suited for AC voltage detection. The ILD620GB and ILQ620GB with its low I_F guaranteed CTR_{CEsat} minimizes power dissipation of the A_C voltage detection network that is placed in series with the LEDs. Eliminating the phototransistor base connection provides added electrical noise immunity from the transients found in many industrial control environments.

AGENCY APPROVALS

- UL1577, file no. E52744 system code H, double protection
- cUL tested to CSA 22.2 bulletin 5A
- DIN EN 60747-5-5 (VDE 0884)
- FIMKO
- CQC GB4943.1-2011 and GB8898:2011 (suitable for installation altitude below 2000 m)

ORDERING INFORMATION



PART NUMBER

PACKAGE OPTION

 TAPE
AND
REEL

x = D (Dual) or Q (Quad)

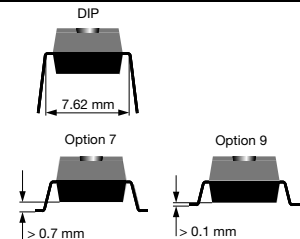

AGENCY CERTIFIED/PACKAGE	DUAL CHANNEL		QUAD CHANNEL	
	CTR (%)			
UL, cUL, FIMKO	50 to 600	100 to 600	50 to 600	100 to 600
DIP-8	ILD620	ILD620GB	-	-
SMD-8, option 7	ILD620-X007T ⁽¹⁾	-	-	-
SMD-8, option 9	ILD620-X009T ⁽¹⁾	ILD620GB-X009T ⁽¹⁾	-	-
DIP-16	-	-	ILQ620	ILQ620GB
SMD-16, option 7	-	-	ILQ620-X007	-
SMD-16, option 9	-	-	ILQ620-X009T ⁽¹⁾	ILQ620GB-X009T ⁽¹⁾
VDE, UL, cUL, FIMKO	50 to 600	100 to 600	50 to 600	100 to 600
DIP-16	-	-	ILQ620-X001	-
SMD-16, option 9	-	-	ILQ620-X019T ⁽¹⁾	-

Notes

- Additional options may be possible, please contact sales office.
- (1) Also available in tubes, do not put T on the end.



ABSOLUTE MAXIMUM RATINGS (T _{amb} = 25 °C, unless otherwise specified)					
PARAMETER	TEST CONDITION	PART	SYMBOL	VALUE	UNIT
INPUT					
Forward current			I _F	± 60	mA
Surge current			I _{FSM}	± 1.5	A
Power dissipation			P _{diss}	100	mW
Derate linearly from 25 °C				1.3	mW/°C
OUTPUT					
Collector emitter breakdown voltage			BV _{CEO}	70	V
Collector current			I _C	50	mA
	t < 1 s		I _C	100	mA
Power dissipation			P _{diss}	150	mW
Derate from 25 °C				2	mW/°C
COUPLER					
Isolation test voltage	t = 1 s		V _{ISO}	5300	V _{RMS}
Isolation voltage			V _{IORM}	890	V _P
Total power dissipation			P _{tot}	250	mW
Package dissipation		ILD620		400	mW
		ILD620GB		400	mW
Derate from 25 °C				5.33	mW/°C
Package dissipation		ILQ620		500	mW
		ILQ620GB		500	mW
Derate from 25 °C				6.67	mW/°C
Creepage distance				≥ 7	mm
Clearance distance				≥ 7	mm
Isolation resistance	V _{IO} = 500 V, T _{amb} = 25 °C		R _{IO}	≥ 10 ¹²	Ω
	V _{IO} = 500 V, T _{amb} = 100 °C		R _{IO}	≥ 10 ¹¹	Ω
Storage temperature			T _{stg}	- 55 to + 150	°C
Operating temperature			T _{amb}	- 55 to + 100	°C
Junction temperature			T _j	100	°C
Soldering temperature ⁽¹⁾	2 mm from case bottom		T _{sld}	260	°C

Notes

- Stresses in excess of the absolute maximum ratings can cause permanent damage to the device. Functional operation of the device is not implied at these or any other conditions in excess of those given in the operational sections of this document. Exposure to absolute maximum ratings for extended periods of the time can adversely affect reliability.
- ⁽¹⁾ Refer to reflow profile for soldering conditions for surface mounted devices (SMD). Refer to wave profile for soldering conditions for through hole devices (DIP).

ELECTRICAL CHARACTERISTICS (T _{amb} = 25 °C, unless otherwise specified)							
PARAMETER	TEST CONDITION	PART	SYMBOL	MIN.	TYP.	MAX.	UNIT
INPUT							
Forward voltage	I _F = ± 10 mA		V _F	1	1.15	1.3	V
Forward current	V _R = ± 0.7 V		I _F		2.5	20	μA
Capacitance	V _F = 0 V, f = 1 MHz		C _O		25		pF
Thermal resistance, junction to lead			R _{thJL}		750		K/W
OUTPUT							
Collector emitter capacitance	V _{CE} = 5 V, f = 1 MHz		C _{CE}		6.8		pF
Collector emitter leakage current	V _{CE} = 24 V		I _{CEO}		10	100	nA
	T _A = 85 °C, V _{CE} = 24 V		I _{CEO}		2	50	μA
Thermal resistance, junction to lead			R _{thJL}		500		K/W



ELECTRICAL CHARACTERISTICS ($T_{amb} = 25\text{ }^{\circ}\text{C}$, unless otherwise specified)							
PARAMETER	TEST CONDITION	PART	SYMBOL	MIN.	TYP.	MAX.	UNIT
COUPLER							
Off-state collector current	$V_F = \pm 0.7\text{ V}$, $V_{CE} = 24\text{ V}$		I_{CEoff}		1	10	μA
Collector emitter saturation voltage	$I_F = \pm 8\text{ mA}$, $I_{CE} = 2.4\text{ mA}$	ILD620	V_{CEsat}			0.4	V
		ILQ620	V_{CEsat}			0.4	V
	$I_F = \pm 1\text{ mA}$, $I_{CE} = 0.2\text{ mA}$	ILD620GB	V_{CEsat}			0.4	V
		ILQ620GB	V_{CEsat}			0.4	V

Note

- Minimum and maximum values are testing requirements. Typical values are characteristics of the device and are the result of engineering evaluation. Typical values are for information only and are not part of the testing requirements.

CURRENT TRANSFER RATIO ($T_{amb} = 25\text{ }^{\circ}\text{C}$, unless otherwise specified)							
PARAMETER	TEST CONDITION	PART	SYMBOL	MIN.	TYP.	MAX.	UNIT
Channel/channel CTR match	$I_F = \pm 5\text{ mA}$, $V_{CE} = 5\text{ V}$		CTR _X /CTR _Y	1 to 1		3 to 1	
CTR symmetry	$I_{CE} (I_F = -5\text{ mA})/I_{CE} (I_F = +5\text{ mA})$		$I_{CE(RATIO)}$	0.5		2	
Current transfer ratio (collector emitter saturated)	$I_F = \pm 1\text{ mA}$, $V_{CE} = 0.4\text{ V}$	ILD620	CTR _{CEsat}		60		%
		ILQ620	CTR _{CEsat}		60		%
Current transfer ratio (collector emitter)	$I_F = \pm 5\text{ mA}$, $V_{CE} = 5\text{ V}$	ILD620	CTR _{CE}	50	80	600	%
		ILQ620	CTR _{CE}	50	80	600	%
Current transfer ratio (collector emitter saturated)	$I_F = \pm 1\text{ mA}$, $V_{CE} = 0.4\text{ V}$	ILD620GB	CTR _{CEsat}	30			%
		ILQ620GB	CTR _{CEsat}	30			%
Current transfer ratio (collector emitter)	$I_F = \pm 5\text{ mA}$, $V_{CE} = 5\text{ V}$	ILD620GB	CTR _{CEsat}	100	200	600	%
		ILQ620GB	CTR _{CEsat}	100	200	600	%

SAFETY AND INSULATION RATED PARAMETERS							
PARAMETER	TEST CONDITION	SYMBOL	MIN.	TYP.	MAX.	UNIT	
Partial discharge test voltage - routine test	100 %, $t_{test} = 1\text{ s}$	V_{pd}	1.669			kV	
Partial discharge test voltage - lot test (sample test)	$t_{Tr} = 60\text{ s}$, $t_{test} = 10\text{ s}$, (see figure 2)	V_{IOTM}	10			kV	
		V_{pd}	1.424			kV	
Insulation resistance	$V_{IO} = 500\text{ V}$	R_{IO}	10^{12}			Ω	
	$V_{IO} = 500\text{ V}$, $T_{amb} = 100\text{ }^{\circ}\text{C}$	R_{IO}	10^{11}			Ω	
	$V_{IO} = 500\text{ V}$, $T_{amb} = 150\text{ }^{\circ}\text{C}$ (construction test only)	R_{IO}	10^9			Ω	
Forward current		I_{si}			275	mA	
Power dissipation		P_{SO}			400	mW	
Rated impulse voltage		V_{IOTM}			10	kV	
Safety temperature		T_{si}			175	$^{\circ}\text{C}$	

Note

- According to DIN EN 60747-5-5 (VDE 0884) (see figure 2). This optocoupler is suitable for safe electrical isolation only within the safety ratings. Compliance with the safety ratings shall be ensured by means of suitable protective circuits.

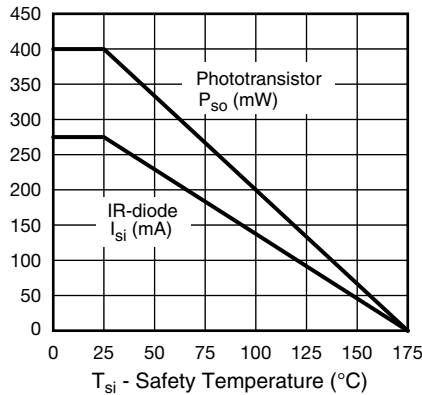

Fig. 1 - Derating Diagram

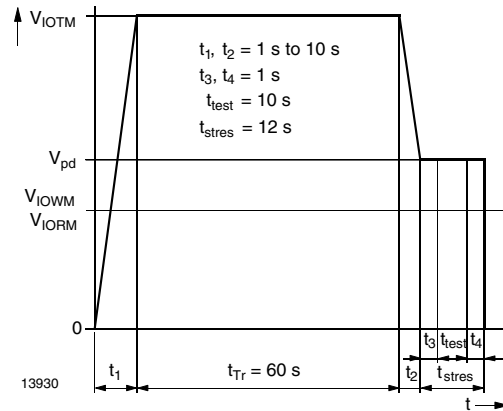

Fig. 2 - Test Pulse Diagram for Sample Test According to DIN EN 60747-5-2 (VDE 0884); IEC 60747-5-5

SWITCHING CHARACTERISTICS ($T_{amb} = 25$ °C, unless otherwise specified)						
PARAMETER	TEST CONDITION	SYMBOL	MIN.	TYP.	MAX.	UNIT
NON-SATURATED						
On time	$I_F = \pm 10$ mA, $V_{CC} = 5$ V, $R_L = 75$ Ω , 50 % of V_{PP}	t_{on}		3		μ s
Rise time	$I_F = \pm 10$ mA, $V_{CC} = 5$ V, $R_L = 75$ Ω , 50 % of V_{PP}	t_r		20		μ s
Off time	$I_F = \pm 10$ mA, $V_{CC} = 5$ V, $R_L = 75$ Ω , 50 % of V_{PP}	t_{off}		2.3		μ s
Fall time	$I_F = \pm 10$ mA, $V_{CC} = 5$ V, $R_L = 75$ Ω , 50 % of V_{PP}	t_f		2		μ s
Propagation H to L	$I_F = \pm 10$ mA, $V_{CC} = 5$ V, $R_L = 75$ Ω , 50 % of V_{PP}	t_{PHL}		1.1		μ s
Propagation L to H	$I_F = \pm 10$ mA, $V_{CC} = 5$ V, $R_L = 75$ Ω , 50 % of V_{PP}	t_{PLH}		2.5		μ s
SATURATED						
On time	$I_F = \pm 10$ mA, $V_{CC} = 5$ V, $R_L = 1$ k Ω , $V_{TH} = 1.5$ V,	t_{on}		4.3		μ s
Rise time	$I_F = \pm 10$ mA, $V_{CC} = 5$ V, $R_L = 1$ k Ω , $V_{TH} = 1.5$ V,	t_r		2.8		μ s
Off time	$I_F = \pm 10$ mA, $V_{CC} = 5$ V, $R_L = 1$ k Ω , $V_{TH} = 1.5$ V,	t_{off}		2.5		μ s
Fall time	$I_F = \pm 10$ mA, $V_{CC} = 5$ V, $R_L = 1$ k Ω , $V_{TH} = 1.5$ V,	t_f		11		μ s
Propagation H to L	$I_F = \pm 10$ mA, $V_{CC} = 5$ V, $R_L = 1$ k Ω , $V_{TH} = 1.5$ V,	t_{PHL}		2.6		μ s
Propagation L to H	$I_F = \pm 10$ mA, $V_{CC} = 5$ V, $R_L = 1$ k Ω , $V_{TH} = 1.5$ V,	t_{PLH}		7.2		μ s

TYPICAL CHARACTERISTICS (T_{amb} = 25 °C, unless otherwise specified)



Fig. 3 - Non-Saturated Switching Timing

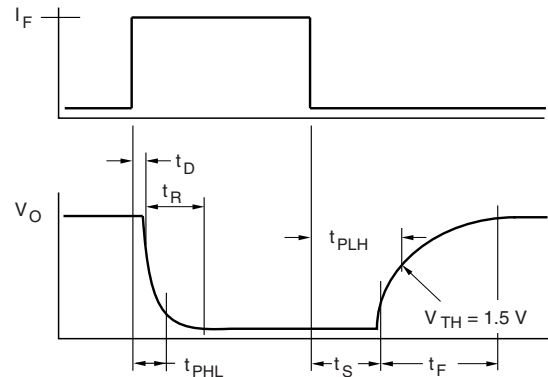

Fig. 6 - Saturated Switching Timing



Fig. 4 - Saturated Switching Timing

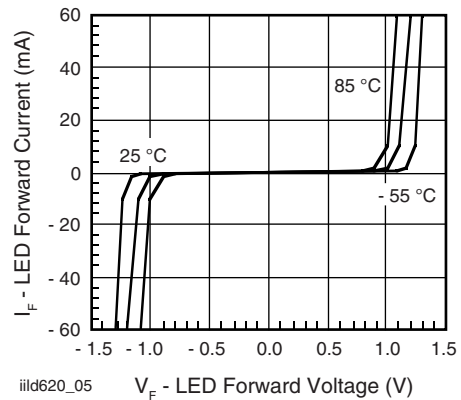

Fig. 7 - LED Forward Current vs. Forward Voltage

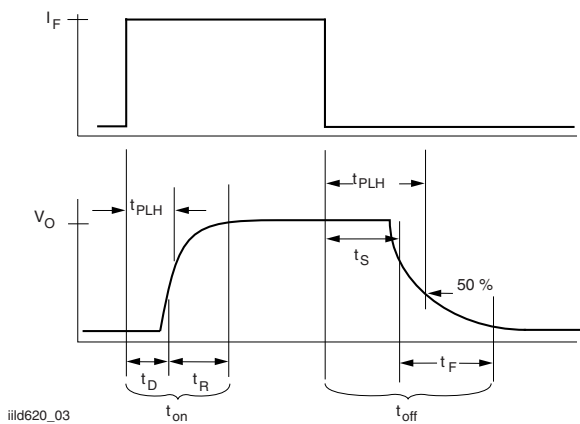

Fig. 5 - Non-Saturated Switching Timing

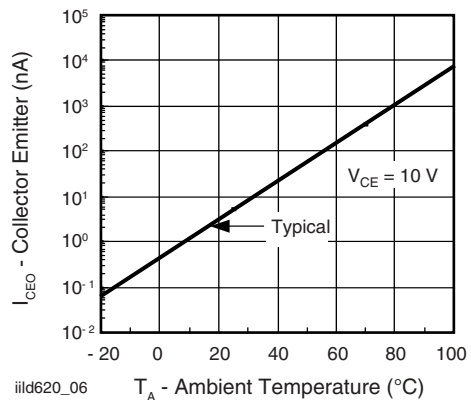

Fig. 8 - Collector Emitter Leakage vs. Temperature

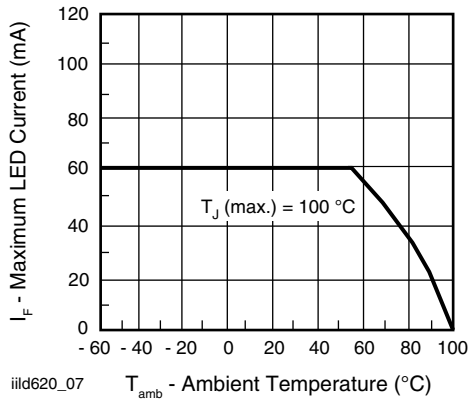

Fig. 9 - Maximum LED Current vs. Ambient Temperature

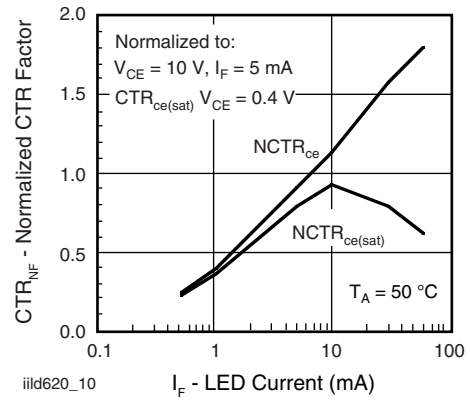

Fig. 12 - Normalization Factor for Non-Saturated and Saturated CTR vs. I_F

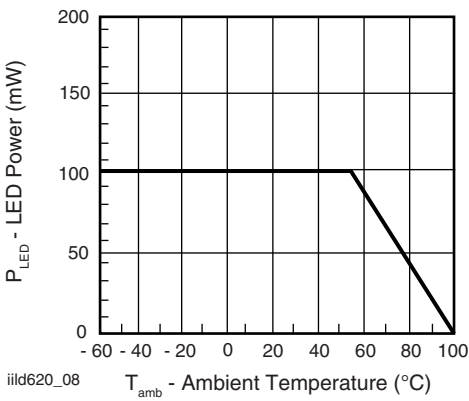

Fig. 10 - Maximum LED Power Dissipation

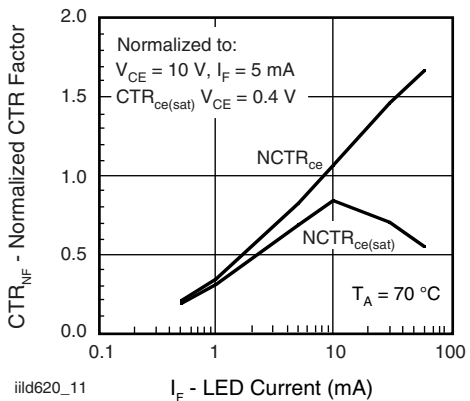

Fig. 13 - Normalization Factor for Non-Saturated and Saturated CTR vs. I_F

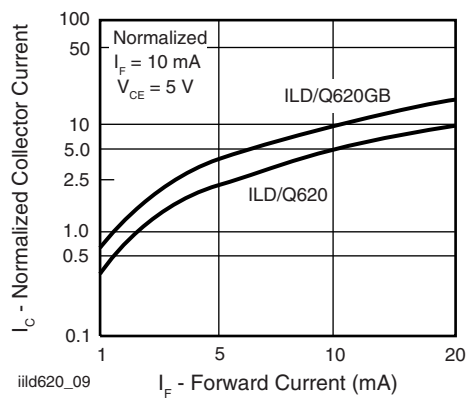

Fig. 11 - Collector Current vs. Diode Forward Current

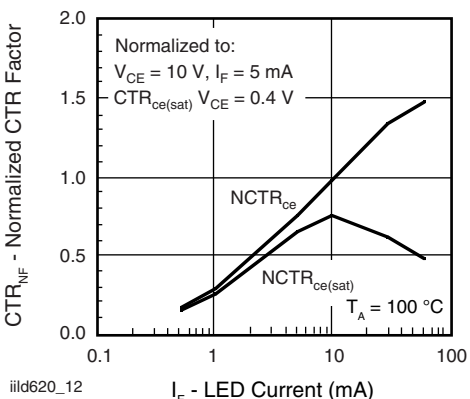

Fig. 14 - Normalization Factor for Non-Saturated and Saturated CTR vs. I_F



Fig. 15 - Peak LED Current vs. Pulse Duration, τ

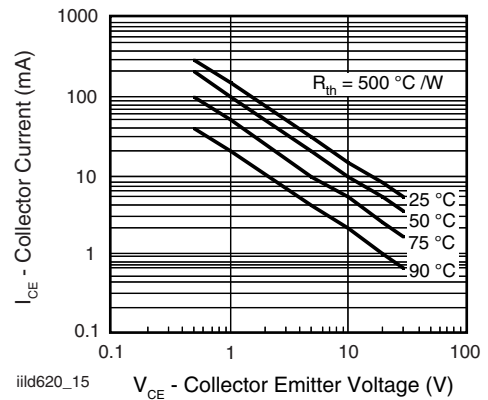
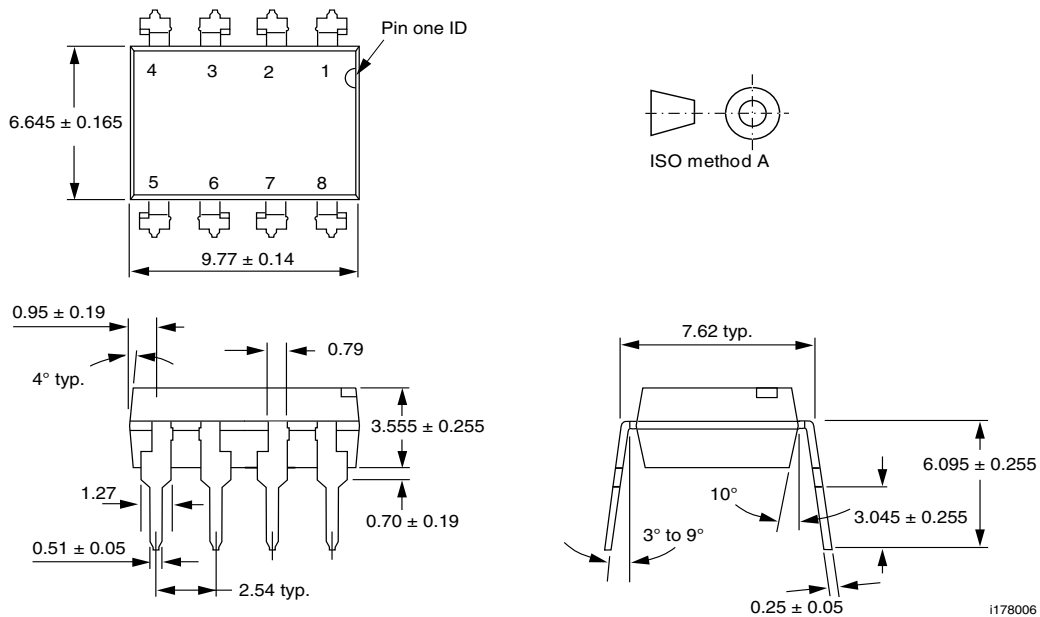

Fig. 17 - Maximum Collector Current vs. Collector Voltage



Fig. 16 - Maximum Detector Power Dissipation

PACKAGE DIMENSIONS in millimeters



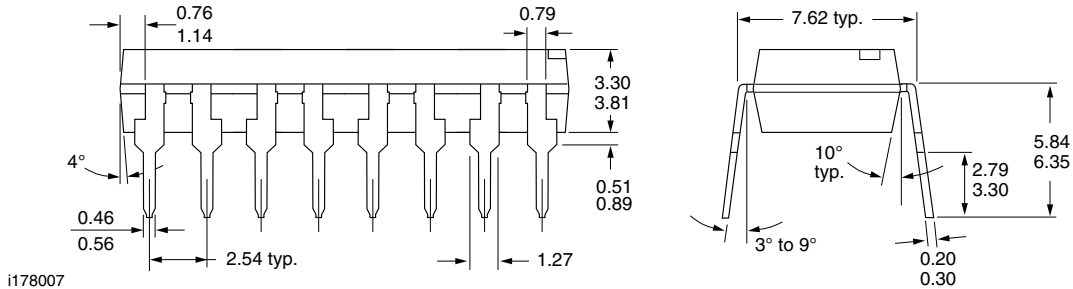
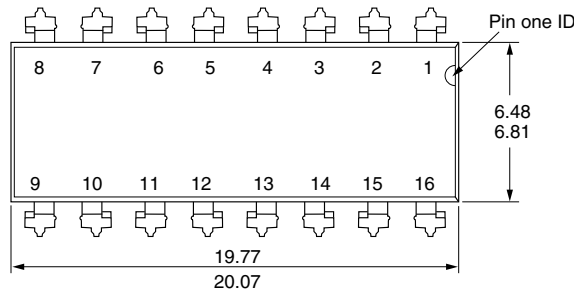

i178007

Option 7

Option 9

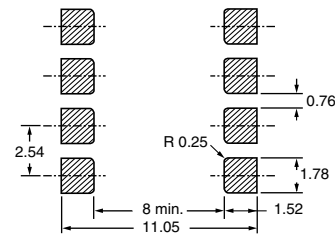
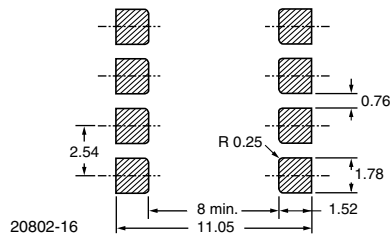
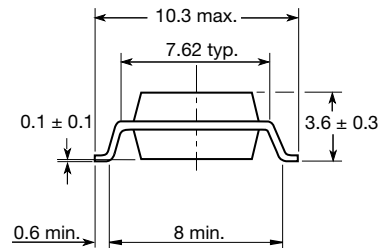
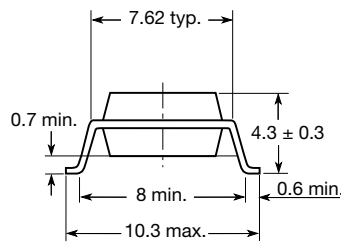

PACKAGE MARKING (example)

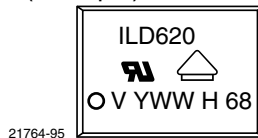

21764-95

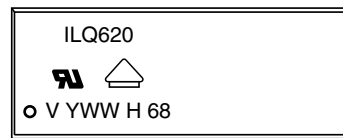

Notes

- Only option 1 and 7 reflected in the package marking.
- The VDE logo is only marked on option 1 parts.
- Tape and reel suffix (T) is not part of the package marking.



Disclaimer

ALL PRODUCT, PRODUCT SPECIFICATIONS AND DATA ARE SUBJECT TO CHANGE WITHOUT NOTICE TO IMPROVE RELIABILITY, FUNCTION OR DESIGN OR OTHERWISE.

Vishay Intertechnology, Inc., its affiliates, agents, and employees, and all persons acting on its or their behalf (collectively, "Vishay"), disclaim any and all liability for any errors, inaccuracies or incompleteness contained in any datasheet or in any other disclosure relating to any product.

Vishay makes no warranty, representation or guarantee regarding the suitability of the products for any particular purpose or the continuing production of any product. To the maximum extent permitted by applicable law, Vishay disclaims (i) any and all liability arising out of the application or use of any product, (ii) any and all liability, including without limitation special, consequential or incidental damages, and (iii) any and all implied warranties, including warranties of fitness for particular purpose, non-infringement and merchantability.

Statements regarding the suitability of products for certain types of applications are based on Vishay's knowledge of typical requirements that are often placed on Vishay products in generic applications. Such statements are not binding statements about the suitability of products for a particular application. It is the customer's responsibility to validate that a particular product with the properties described in the product specification is suitable for use in a particular application. Parameters provided in datasheets and / or specifications may vary in different applications and performance may vary over time. All operating parameters, including typical parameters, must be validated for each customer application by the customer's technical experts. Product specifications do not expand or otherwise modify Vishay's terms and conditions of purchase, including but not limited to the warranty expressed therein.

Except as expressly indicated in writing, Vishay products are not designed for use in medical, life-saving, or life-sustaining applications or for any other application in which the failure of the Vishay product could result in personal injury or death. Customers using or selling Vishay products not expressly indicated for use in such applications do so at their own risk. Please contact authorized Vishay personnel to obtain written terms and conditions regarding products designed for such applications.

No license, express or implied, by estoppel or otherwise, to any intellectual property rights is granted by this document or by any conduct of Vishay. Product names and markings noted herein may be trademarks of their respective owners.