

Standard Rectifier Module

3~ Rectifier
$V_{RRM} = 1200\text{ V}$
$I_{DAV} = 120\text{ A}$
$I_{FSM} = 1500\text{ A}$

3~ Rectifier Bridge

Part number

VUO105-12NO7

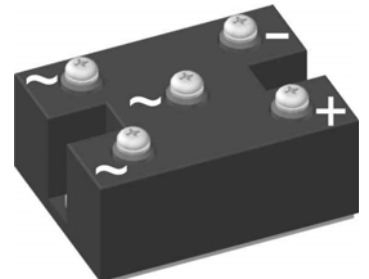

 E72873

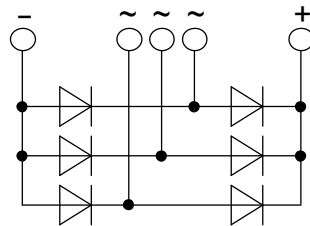

Features / Advantages:

- Package with DCB ceramic
- Improved temperature and power cycling
- Planar passivated chips
- Very low forward voltage drop
- Very low leakage current

Applications:

- Diode for main rectification
- For three phase bridge configurations
- Supplies for DC power equipment
- Input rectifiers for PWM inverter
- Battery DC power supplies
- Field supply for DC motors

Package: PWS-C

- Industry standard outline
- RoHS compliant
- Easy to mount with two screws
- Base plate: Copper internally DCB isolated
- Advanced power cycling

Rectifier				Ratings				
Symbol	Definition	Conditions		min.	typ.	max.	Unit	
V_{RSM}	max. non-repetitive reverse blocking voltage					1300	V	
V_{RRM}	max. repetitive reverse blocking voltage					1200	V	
I_R	reverse current	$V_R = 1200$ V	$T_{VJ} = 25^\circ\text{C}$			100	μA	
		$V_R = 1200$ V	$T_{VJ} = 150^\circ\text{C}$			2	mA	
V_F	forward voltage drop	$I_F = 40$ A	$T_{VJ} = 25^\circ\text{C}$			1.09	V	
						1.38	V	
		$I_F = 120$ A	$T_{VJ} = 125^\circ\text{C}$			1.00	V	
						1.36	V	
I_{DAV}	bridge output current	$T_C = 105^\circ\text{C}$ rectangular $d = \frac{1}{3}$	$T_{VJ} = 150^\circ\text{C}$			120	A	
V_{FO}	threshold voltage	} for power loss calculation only				0.78	V	
r_F	slope resistance					4.8	m Ω	
R_{thJC}	thermal resistance junction to case					0.8	K/W	
R_{thCH}	thermal resistance case to heatsink				0.30		K/W	
P_{tot}	total power dissipation			$T_C = 25^\circ\text{C}$		155	W	
I_{FSM}	max. forward surge current	$t = 10$ ms; (50 Hz), sine	$T_{VJ} = 45^\circ\text{C}$			1.50	kA	
						1.62	kA	
		$t = 8,3$ ms; (60 Hz), sine	$V_R = 0$ V	$T_{VJ} = 150^\circ\text{C}$			1.28	kA
							1.38	kA
I^2t	value for fusing	$t = 10$ ms; (50 Hz), sine	$T_{VJ} = 45^\circ\text{C}$			11.3	kA ² s	
						10.9	kA ² s	
		$t = 8,3$ ms; (60 Hz), sine	$V_R = 0$ V	$T_{VJ} = 150^\circ\text{C}$			8.13	kA ² s
							7.87	kA ² s
C_J	junction capacitance	$V_R = 400$ V; $f = 1$ MHz	$T_{VJ} = 25^\circ\text{C}$		58		pF	

Package PWS-C			Ratings			
Symbol	Definition	Conditions	min.	typ.	max.	Unit
I_{RMS}	RMS current	per terminal			150	A
T_{stg}	storage temperature		-40		125	°C
T_{VJ}	virtual junction temperature		-40		150	°C
Weight				250		g
M_D	mounting torque		4.25		5.75	Nm
M_T	terminal torque		4.25		5.75	Nm
$d_{Spp/App}$	creepage distance on surface striking distance through air	terminal to terminal	26.0			mm
$d_{Spb/Appb}$		terminal to backside	14.0			mm
V_{ISOL}	isolation voltage	t = 1 second	3000			V
		t = 1 minute	2500			V

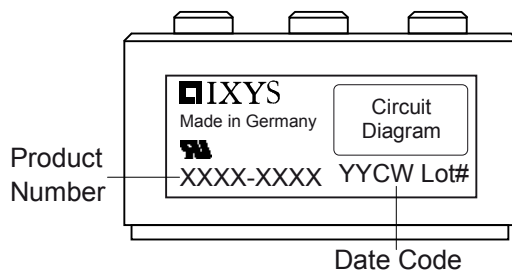

Ordering	Part Number	Marking on Product	Delivery Mode	Quantity	Code No.
Standard	VUO105-12NO7	VUO105-12NO7	Box	10	456713

Equivalent Circuits for Simulation

* on die level

$T_{VJ} = 150\text{ °C}$

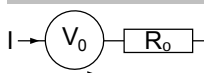

Rectifier

$V_{0\ max}$	threshold voltage	0.78	V
$R_{0\ max}$	slope resistance *	3.6	mΩ

Outlines PWS-C

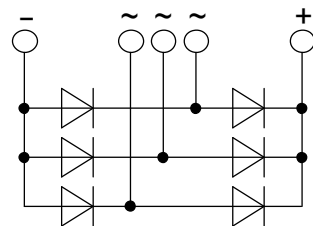
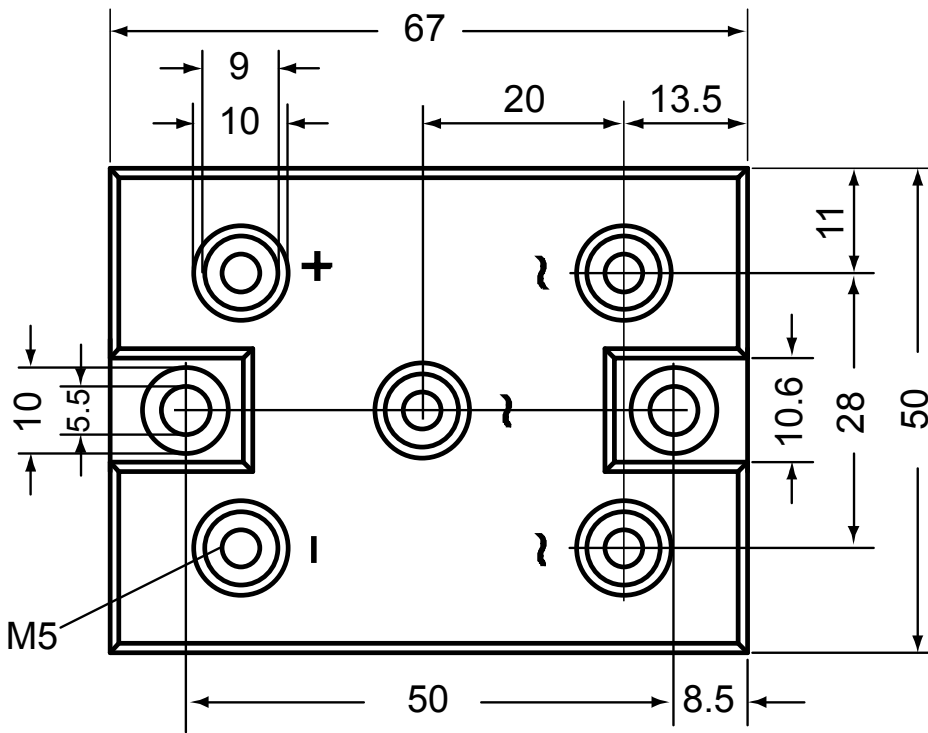
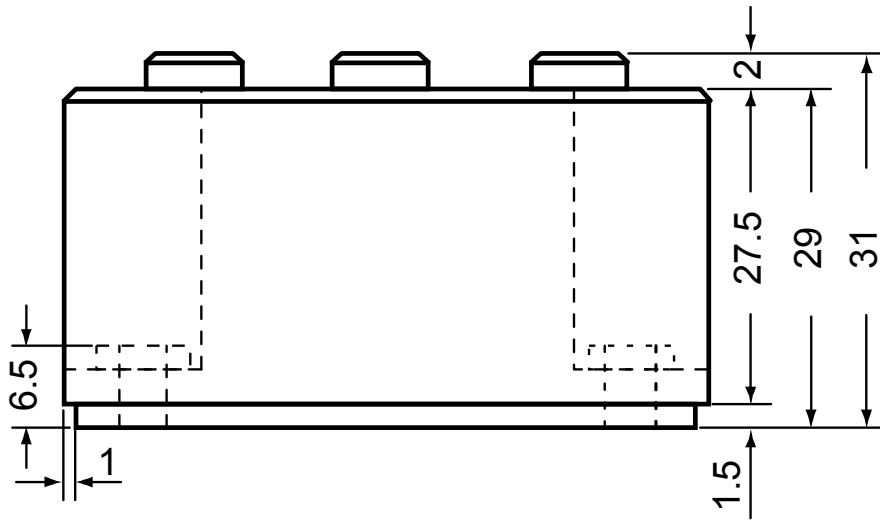

Rectifier

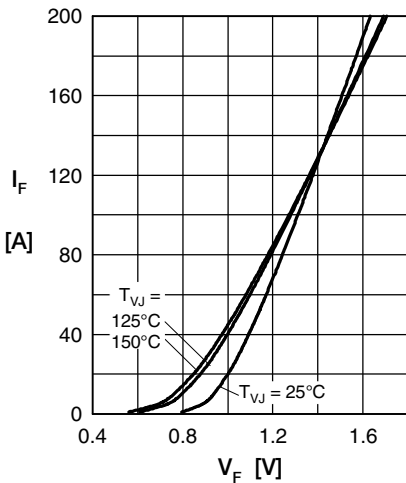

Fig. 1 Forward current versus voltage drop per diode

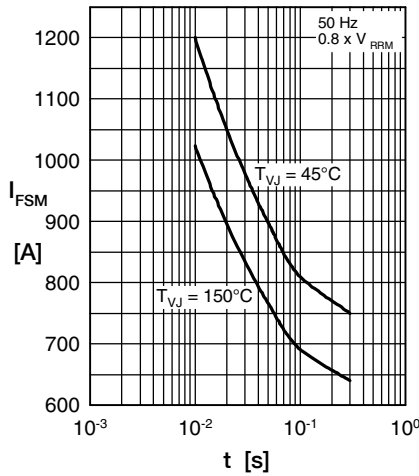

Fig. 2 Surge overload current vs. time per diode

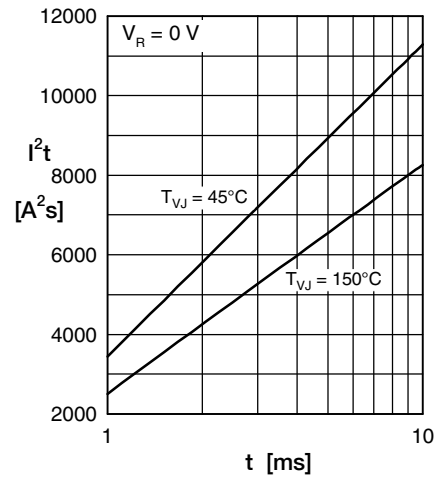

Fig. 3 I^2t versus time per diode

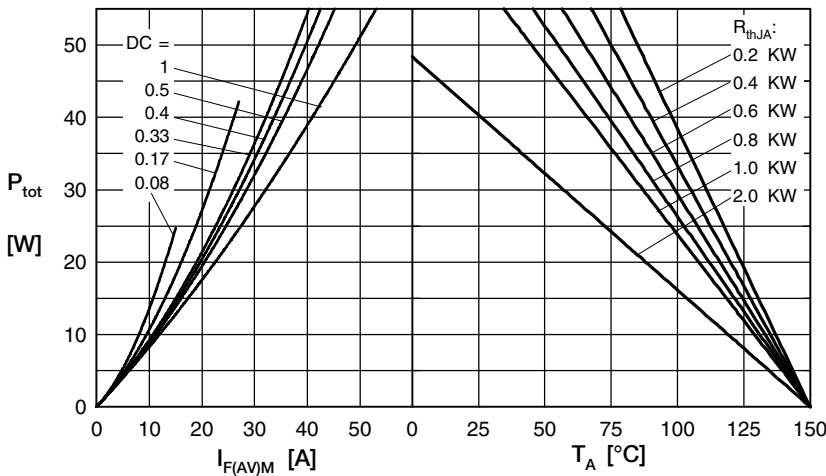

Fig. 4 Power dissipation vs. forward current and ambient temperature per diode

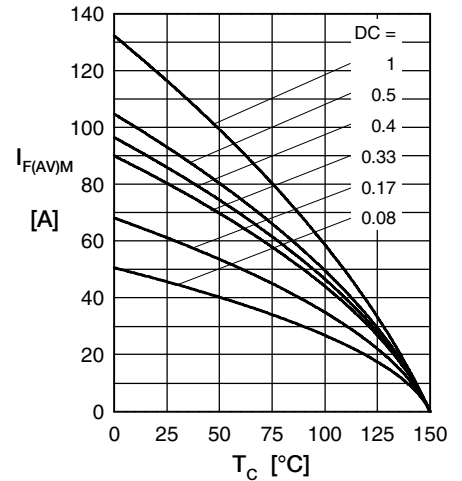

Fig. 5 Max. forward current vs. case temperature per diode

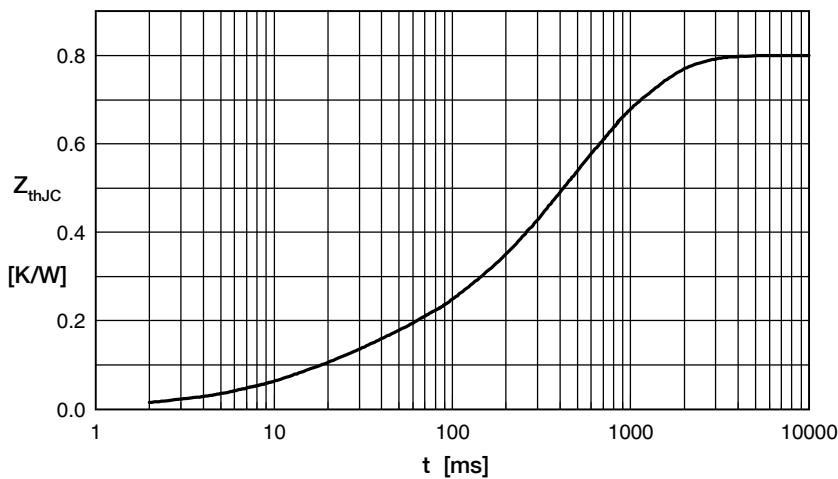

Fig. 6 Transient thermal impedance junction to case vs. time per diode

Constants for Z_{thJC} calculation:

i	R_{th} (K/W)	t_i (s)
1	0.100	0.020
2	0.014	0.010
3	0.192	0.225
4	0.281	0.800
5	0.213	0.580