

LMx19 High Speed Dual Comparator

1 Features

- Two Independent Comparators
- Operates from a Single 5-V Supply
- Typically 80-ns Response Time at ± 15 V
- Minimum Fan-out of 2 Each Side
- Maximum Input Current of 1 μ A Over Temperature
- Inputs and Outputs can be Isolated from System Ground
- High Common-Mode Slew Rate

Connection Diagram

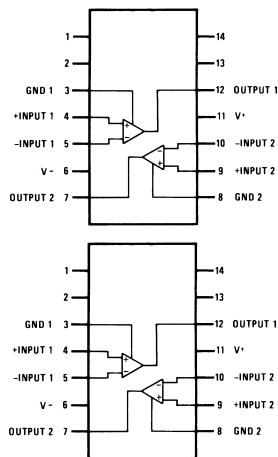

Typical Application - Relay Driver

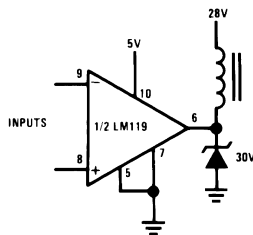

2 Description

The LM119 series are precision high-speed dual comparators fabricated on a single monolithic chip. They are designed to operate over a wide range of supply voltages down to a single 5-V logic supply and ground. They have higher gain and lower input currents than devices such as the LM710. The uncommitted collector of the output stage makes the LM119 compatible with RTL, DTL, and TTL, as well as capable of driving lamps and relays at currents of up to 25 mA.

The LM319A offers improved precision over the standard LM319, with tighter tolerances on offset voltage, offset current, and voltage gain.

Although designed primarily for applications requiring operation from digital logic supplies, the LM119 series are fully specified for power supplies up to ± 15 V. The series features faster response than the LM111, at the expense of higher power dissipation. However, the high-speed, wide operating voltage range and low package count make the LM119 more versatile than older devices such as the LM711.

The LM119 is specified from -55°C to $+125^{\circ}\text{C}$, the LM219 is specified from -25°C to $+85^{\circ}\text{C}$, and the LM319A and LM319 are specified from 0°C to $+70^{\circ}\text{C}$.

Device Information⁽¹⁾

PART NUMBER	PACKAGE	BODY SIZE (NOM)
LM119, LM219, LM319	TO-100 (10)	8.96 mm x 8.96 mm
	CDIP (14)	6.67 mm x 19.56 mm

(1) For all available packages, see the orderable addendum at the end of the data sheet.



Table of Contents

1 Features	1	6 Detailed Description	10
2 Description	1	6.1 Functional Block Diagram	10
3 Revision History	2	7 Application and Implementation	11
4 Pin Configuration and Functions	3	7.1 Typical Applications	11
5 Specifications	4	8 Device and Documentation Support	12
5.1 Absolute Maximum Ratings	4	8.1 Related Links	12
5.2 ESD Ratings	4	8.2 Community Resources	12
5.3 Thermal Information	4	8.3 Trademarks	12
5.4 Electrical Characteristics LM119, LM219	5	8.4 Electrostatic Discharge Caution	12
5.5 Electrical Characteristics LM319, LM319A	6	8.5 Glossary	12
5.6 Typical Characteristics	7	9 Mechanical, Packaging, and Orderable Information	12

3 Revision History

Changes from Revision A (May 2004) to Revision B	Page
• Changed datasheet to new TI format from National.	1
• Added <i>Pin Functions</i> and <i>Thermal Information</i> tables, the <i>Device and Documentation Support</i> section, and <i>Mechanical, Packaging, and Orderable Information</i> section	1

4 Pin Configuration and Functions

**D, J, or NFF Package
14-Pins CDIP and PDIP
Top View**

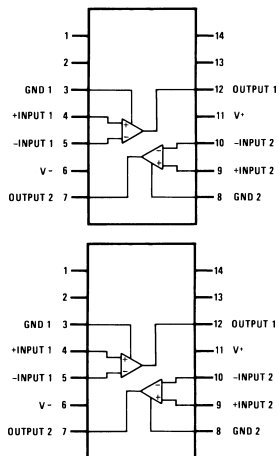

**LME Package
10-Pins TO-100 (Metal Can Package)
Top View**

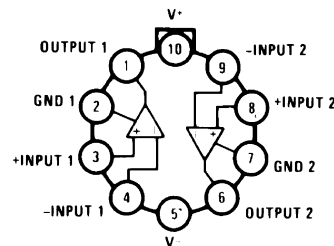

**NAD Package
10-Pins CFP
Top View**

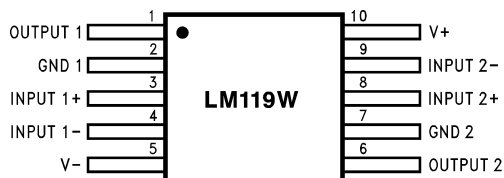

Pin Functions

NAME	PIN			I/O	DESCRIPTION
	NO. (D, J, NFF 14)	NO. (LME 10)	NO. (NAD 10)		
OUTPUT 1	1	12	1	O	Comparator 1 output
GND 1	2	3	2	G	Comparator 1 ground connection
INPUT 1+	3	4	3	I	Comparator 1 input
INPUT 1-	4	5	4	I	Comparator 1 input
V-	5	6	5	P	Negative supply voltage
OUTPUT 2	6	7	6	O	Comparator 2 output
GND 2	7	8	7	G	Comparator 2 ground connection
INPUT 2+	8	9	8	I	Comparator 2 input
INPUT 2-	9	10	9	I	Comparator 2 input
V+	10	11	10	P	Positive supply voltage
NC	1,2,13,14				No connect. Do not connect to ground.

5 Specifications

5.1 Absolute Maximum Ratings

 over operating free-air temperature range (unless otherwise noted)⁽¹⁾⁽²⁾⁽³⁾

		MIN	MAX	UNIT
Total supply voltage			36	V
Output to negative supply voltage			36	V
Ground to negative supply voltage			25	V
Ground to positive supply voltage			18	V
Differential input voltage		-5	+5	V
Input voltage ⁽⁴⁾		-15	+15	V
Power dissipation ⁽⁵⁾			500	mW
Output short circuit duration			10	sec
Lead temperature (soldering, 10 sec.)			260	°C
Soldering information ⁽⁶⁾	Dual-In-Line Package Soldering (10 seconds)		260	°C
	Small Outline Package Vapor Phase (60 seconds)		215	
	Small Outline Package Infrared (15 seconds)		220	
Operating temperature	LM119	-55	125	°C
	LM219	-25	85	
	LM319A, LM319	0	70	
Storage temperature, T _{stg}		-65	150	°C

- (1) Stresses beyond those listed under *Absolute Maximum Ratings* may cause permanent damage to the device. These are stress ratings only, which do not imply functional operation of the device at these or any other conditions beyond those indicated under *Recommended Operating Conditions*. Exposure to absolute-maximum-rated conditions for extended periods may affect device reliability.
- (2) If Military/Aerospace specified devices are required, please contact the Texas Instruments Sales Office/ Distributors for availability and specifications.
- (3) Refer to RETS119X for LM119H/883 and LM119J/883 specifications.
- (4) For supply voltages less than ± 15 V the absolute maximum input voltage is equal to the supply voltage.
- (5) The maximum junction temperature of the LM119 is 150°C, while that of the LM219 is 110°C. For operating at elevated temperatures, devices in the H10 package must be derated based on a thermal resistance of 160°C/W, junction to ambient, or 19°C/W, junction to case. The thermal resistance of the J14 and N14 packages is 100°C/W, junction to ambient.
- (6) See AN-450 "Surface Mounting Methods and Their Effect on Product Reliability" for other methods of soldering surface mount devices.

5.2 ESD Ratings

			VALUE	UNIT
V _(ESD)	Electrostatic discharge	Human body model (HBM), per ANSI/ESDA/JEDEC JS-001 ⁽¹⁾	±800	V

- (1) JEDEC document JEP155 states that 500-V HBM allows safe manufacturing with a standard ESD control process.

5.3 Thermal Information

THERMAL METRIC ⁽¹⁾	LM119, LM219, LM319			UNIT
	TO-100 (LME)	PDIP (NFF)	CDIP (J)	
	10 PINS	14 PINS	14 PINS	
R _{θJA} Junction-to-ambient thermal resistance	160	100	100	°C/W
R _{θJC(top)} Junction-to-case (top) thermal resistance	19	NA	NA	°C/W

- (1) For more information about traditional and new thermal metrics, see the *Semiconductor and IC Package Thermal Metrics* application report, [SPRA953](#).

5.4 Electrical Characteristics LM119, LM219

These specifications apply for $V_S = \pm 15\text{ V}$, and the Ground pin at ground, and $-55^\circ\text{C} \leq T_A \leq +125^\circ\text{C}$, unless otherwise stated. With the LM219, all temperature specifications are limited to $-25^\circ\text{C} \leq T_A \leq +85^\circ\text{C}$. The offset voltage, offset current and bias current specifications apply for any supply voltage from a single 5-V supply up to $\pm 15\text{-V}$ supplies. Do not operate the device with more than 16 V from ground to V_S .

PARAMETER	TEST CONDITIONS	MIN	TYP	MAX	UNIT
Input Offset Voltage ⁽¹⁾	$T_A = 25^\circ\text{C}$, $R_S \leq 5\text{k}$		0.7	4	mV
Input Offset Current ⁽¹⁾	$T_A = 25^\circ\text{C}$		30	75	nA
Input Bias Current	$T_A = 25^\circ\text{C}$		150	500	nA
Voltage Gain	$T_A = 25^\circ\text{C}$ ⁽²⁾	10	40		V/mV
Response Time ⁽³⁾	$T_A = 25^\circ\text{C}$, $V_S = \pm 15\text{ V}$		80		ns
Saturation Voltage	$V_{IN} \leq -5\text{ mV}$, $I_{OUT} = 25\text{ mA}$ $T_A = 25^\circ\text{C}$		0.75	1.5	V
Output Leakage Current	$V_{IN} \geq 5\text{ mV}$, $V_{OUT} = 35\text{ V}$ $T_A = 25^\circ\text{C}$		0.2	2	μA
Input Offset Voltage ⁽¹⁾	$R_S \leq 5\text{k}$			7	mV
Input Offset Current ⁽¹⁾				100	nA
Input Bias Current				1000	nA
Input Voltage Range	$V_S = \pm 15\text{ V}$	-12	± 13	+12	V
	$V^+ = 5\text{ V}$, $V^- = 0$	1		3	
Saturation Voltage	$V^+ \geq 4.5\text{ V}$, $V^- = 0$ $V_{IN} \leq -6\text{ mV}$, $I_{SINK} \leq 3.2\text{ mA}$ $T_A \geq 0^\circ\text{C}$		0.23	0.4	V
	$T_A \leq 0^\circ\text{C}$			0.6	
Output Leakage Current	$V_{IN} \geq 5\text{ mV}$, $V_{OUT} = 35\text{ V}$, $V^- = V_{GND} = 0\text{ V}$		1	10	μA
Differential Input Voltage				± 5	V
Positive Supply Current	$T_A = 25^\circ\text{C}$, $V^+ = 5\text{ V}$, $V^- = 0$		4.3		mA
Positive Supply Current	$T_A = 25^\circ\text{C}$, $V_S = \pm 15\text{ V}$		8	11.5	mA
Negative Supply Current	$T_A = 25^\circ\text{C}$, $V_S = \pm 15\text{ V}$		3	4.5	mA

- (1) The offset voltages and offset currents given are the maximum values required to drive the output within a volt of either supply with a 1-mA load. Thus, these parameters define an error band and take into account the worst case effects of voltage gain and input impedance.
- (2) Output is pulled up to 15 V through a 1.4-kW resistor.
- (3) The response time specified is for a 100-mV input step with 5-mV overdrive.

5.5 Electrical Characteristics LM319, LM319A

These specifications apply for $V_S = \pm 15\text{ V}$, and $0^\circ\text{C} \leq T_A \leq 70^\circ\text{C}$, unless otherwise stated. The offset voltage, offset current, and bias current specifications apply for any supply voltage from a single 5-V supply up to $\pm 15\text{-V}$ supplies. Do not operate the device with more than 16 V from ground to V_S .

PARAMETER	TEST CONDITIONS	LM319A			LM319			UNIT
		MIN	TYP	MAX	MIN	TYP	MAX	
Input Offset Voltage ⁽¹⁾	$T_A = 25^\circ\text{C}$, $R_S \leq 5\text{ k}$		0.5	1		2	8	mV
Input Offset Current ⁽¹⁾	$T_A = 25^\circ\text{C}$		20	40		80	200	nA
Input Bias Current	$T_A = 25^\circ\text{C}$		150	500		250	1000	nA
Voltage Gain	$T_A = 25^\circ\text{C}$ ⁽²⁾	20	40		8	40		V/mV
Response Time ⁽³⁾	$T_A = 25^\circ\text{C}$, $V_S = \pm 15\text{ V}$		80			80		ns
Saturation Voltage	$V_{IN} \leq -10\text{ mV}$, $I_{OUT} = 25\text{ mA}$ $T_A = 25^\circ\text{C}$		0.75	1.5		0.75	1.5	V
Output Leakage Current	$V_{IN} \geq 10\text{ mV}$, $V_{OUT} = 35\text{ V}$ $V^- = V_{GND} = 0\text{ V}$, $T_A = 25^\circ\text{C}$		0.2	10		0.2	10	μA
Input Offset Voltage ⁽¹⁾	$R_S \leq 5\text{ k}$			10			10	mV
Input Offset Current ⁽¹⁾				300			300	nA
Input Bias Current				1000			1200	nA
Input Voltage Range	$V_S = \pm 15\text{ V}$		± 13			± 13		V
	$V^+ = 5\text{ V}$, $V^- = 0$	1		3	1		3	
Saturation Voltage	$V^+ \geq 4.5\text{ V}$, $V^- = 0$ $V_{IN} \leq -10\text{ mV}$, $I_{SINK} \leq 3.2\text{ mA}$		0.3	0.4		0.3	0.4	V
Differential Input Voltage				± 5			± 5	V
Positive Supply Current	$T_A = 25^\circ\text{C}$, $V^+ = 5\text{ V}$, $V^- = 0$		4.3			4.3		mA
Positive Supply Current	$T_A = 25^\circ\text{C}$, $V_S = \pm 15\text{ V}$		8	12.5		8	12.5	mA
Negative Supply Current	$T_A = 25^\circ\text{C}$, $V_S = \pm 15\text{ V}$		3	5		3	5	mA

- (1) The offset voltages and offset currents given are the maximum values required to drive the output within a volt of either supply with a 1-mA load. Thus, these parameters define an error band and take into account the worst case effects of voltage gain and input impedance.
- (2) Output is pulled up to 15 V through a 1.4-kW resistor.
- (3) The response time specified is for a 100-mV input step with 5-mV overdrive.

5.6 Typical Characteristics

5.6.1 Typical Characteristics – LM119, LM119A, LM219

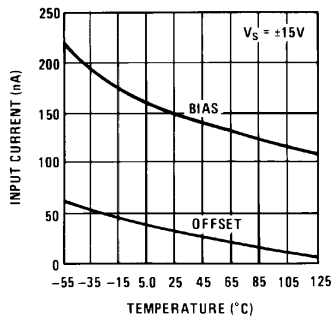

Figure 1. Input Currents

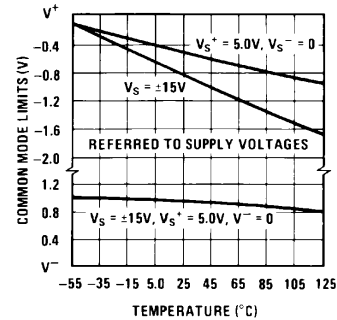

Figure 2. Common-Mode Limits

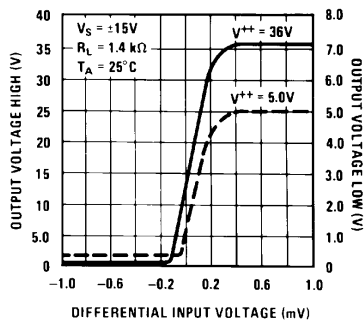

Figure 3. Transfer Function

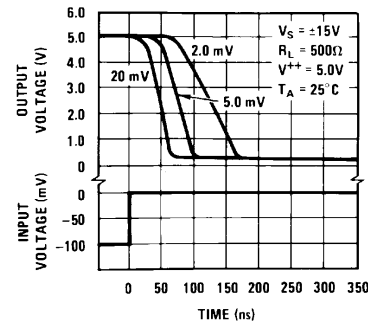

Figure 4. Response Time for Various Input Overdrives

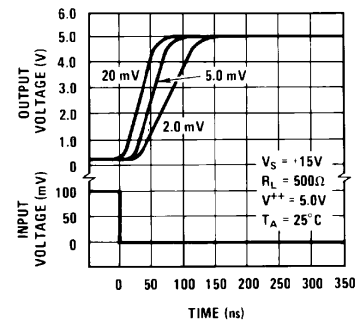

Figure 5. Response Time for Various Input Overdrives

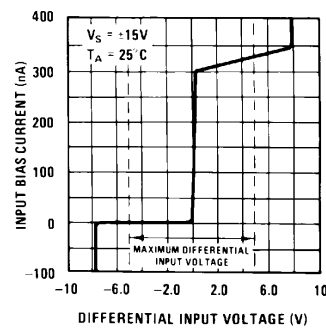

Figure 6. Input Characteristics

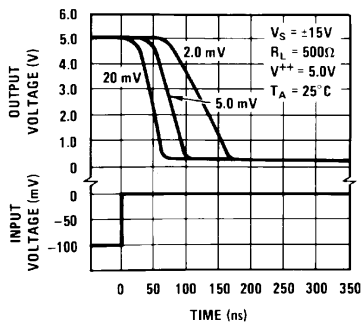

Figure 7. Response Time for Various Input Overdrives

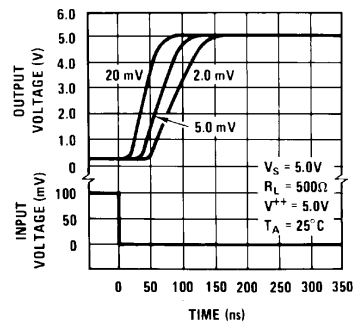

Figure 8. Response Time for Various Input Overdrives

Typical Characteristics – LM119, LM119A, LM219 (continued)

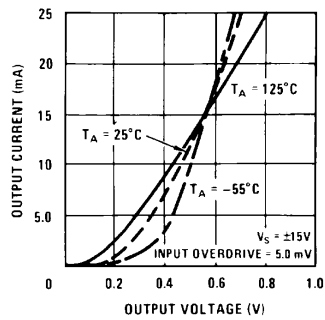

Figure 9. Output Saturation Voltage

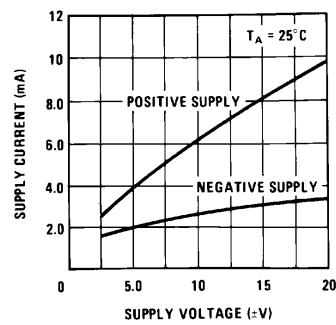

Figure 10. Supply Current

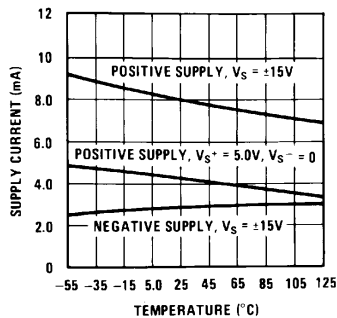

Figure 11. Supply Current

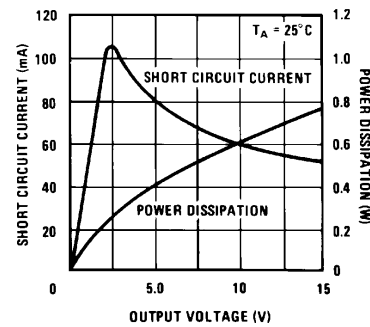

Figure 12. Output Limiting Characteristics

5.6.2 Typical Characteristics – LM319, LM319A

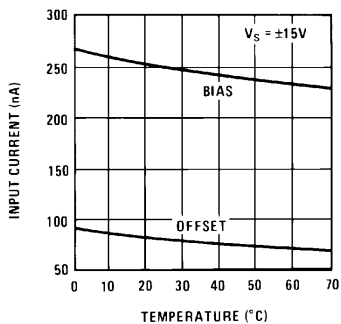

Figure 13. Input Currents

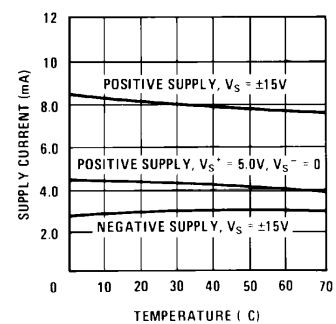

Figure 14. Supply Currents

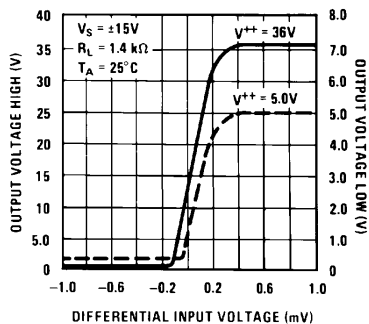

Figure 15. Transfer Function

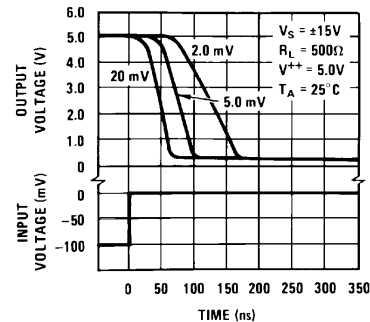

Figure 16. Response Time for Various Input Overdrives

Typical Characteristics – LM319, LM319A (continued)

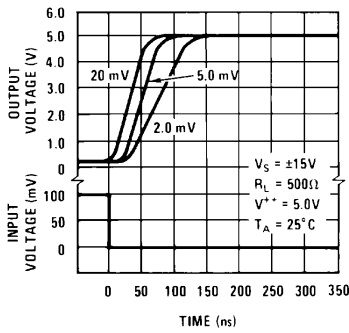

Figure 17. Response Time for Various Input Overdrives

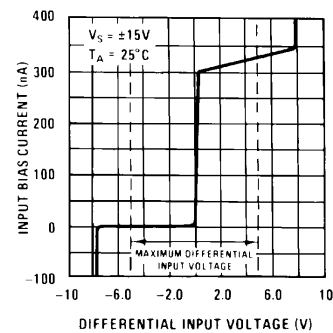

Figure 18. Input Characteristics

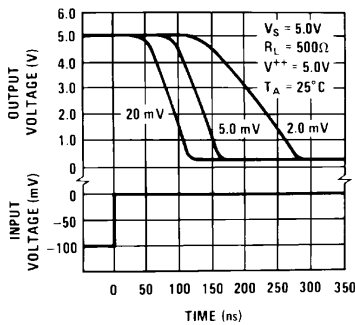

Figure 19. Response Time for Various Input Overdrives

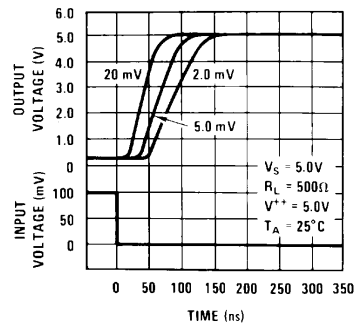

Figure 20. Response Time for Various Input Overdrives

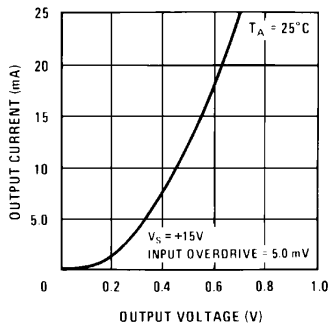

Figure 21. Output Saturation Voltage

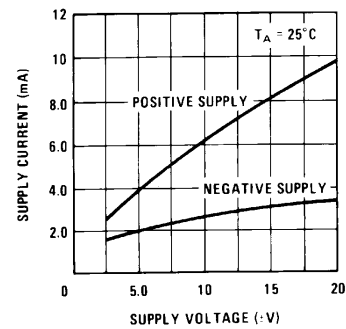

Figure 22. Supply Current

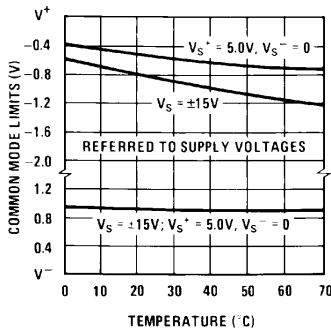

Figure 23. Common-Mode Limits

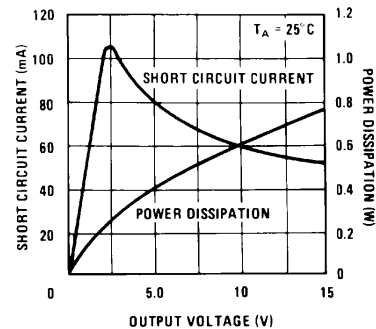
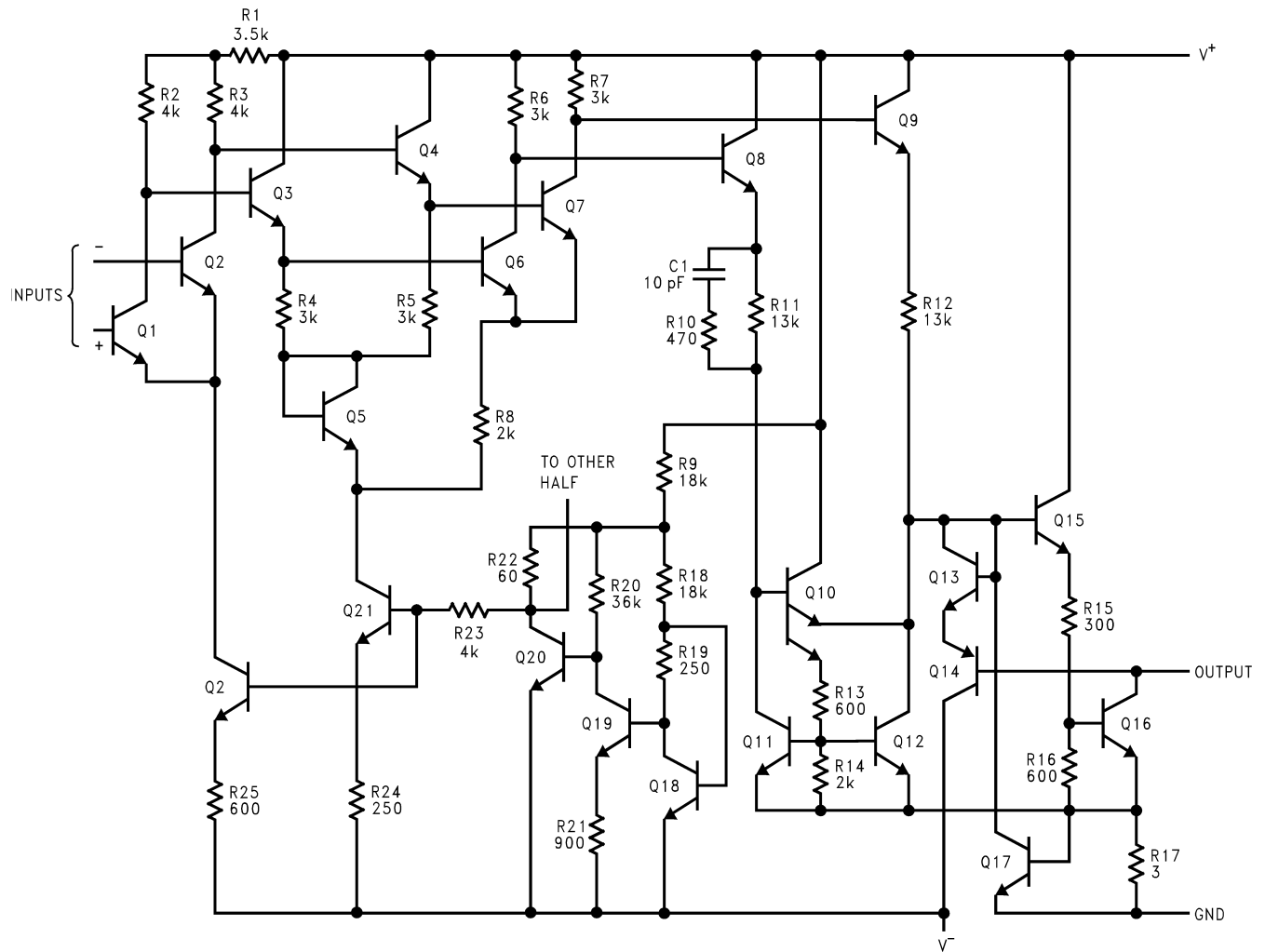

Figure 24. Output Limiting Characteristics

6 Detailed Description

6.1 Functional Block Diagram



DS005705-1

*Do not operate the LM119 with more than 16V between GND and V⁺

7 Application and Implementation

NOTE

Information in the following applications sections is not part of the TI component specification, and TI does not warrant its accuracy or completeness. TI's customers are responsible for determining suitability of components for their purposes. Customers should validate and test their design implementation to confirm system functionality.

7.1 Typical Applications

7.1.1 Relay Driver

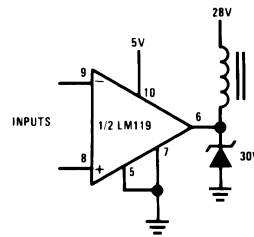

Figure 25. Relay Driver

7.1.2 Window Detector

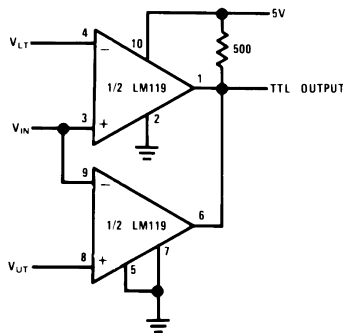

Figure 26. Window Detector

8 Device and Documentation Support

8.1 Related Links

The table below lists quick access links. Categories include technical documents, support and community resources, tools and software, and quick access to sample or buy.

Table 1. Related Links

PARTS	PRODUCT FOLDER	SAMPLE & BUY	TECHNICAL DOCUMENTS	TOOLS & SOFTWARE	SUPPORT & COMMUNITY
LM119	Click here	Click here	Click here	Click here	Click here
LM219	Click here	Click here	Click here	Click here	Click here
LM319	Click here	Click here	Click here	Click here	Click here

8.2 Community Resources

The following links connect to TI community resources. Linked contents are provided "AS IS" by the respective contributors. They do not constitute TI specifications and do not necessarily reflect TI's views; see TI's [Terms of Use](#).

TI E2E™ Online Community *TI's Engineer-to-Engineer (E2E) Community*. Created to foster collaboration among engineers. At e2e.ti.com, you can ask questions, share knowledge, explore ideas and help solve problems with fellow engineers.

Design Support *TI's Design Support* Quickly find helpful E2E forums along with design support tools and contact information for technical support.

8.3 Trademarks

E2E is a trademark of Texas Instruments.

All other trademarks are the property of their respective owners.

8.4 Electrostatic Discharge Caution



These devices have limited built-in ESD protection. The leads should be shorted together or the device placed in conductive foam during storage or handling to prevent electrostatic damage to the MOS gates.

8.5 Glossary

[SLYZ022](#) — *TI Glossary*.

This glossary lists and explains terms, acronyms, and definitions.

9 Mechanical, Packaging, and Orderable Information

The following pages include mechanical, packaging, and orderable information. This information is the most current data available for the designated devices. This data is subject to change without notice and revision of this document. For browser-based versions of this data sheet, refer to the left-hand navigation.

PACKAGING INFORMATION

Orderable Device	Status (1)	Package Type	Package Drawing	Pins	Package Qty	Eco Plan (2)	Lead finish/ Ball material (6)	MSL Peak Temp (3)	Op Temp (°C)	Device Marking (4/5)	Samples
LM119H	ACTIVE	TO-100	LME	10	500	Non-RoHS & Non-Green	Call TI	Call TI	-55 to 125	(LM119H, LM119H)	Samples
LM119H/NOPB	ACTIVE	TO-100	LME	10	500	RoHS & Green	Call TI	Level-1-NA-UNLIM	-55 to 125	(LM119H, LM119H)	Samples
LM119J	ACTIVE	CDIP	J	14	25	Non-RoHS & Green	Call TI	Level-1-NA-UNLIM	-55 to 125	LM119J	Samples
LM319AM	ACTIVE	SOIC	D	14	55	Non-RoHS & Green	Call TI	Level-1-235C-UNLIM	0 to 70	LM319AM	Samples
LM319AM/NOPB	ACTIVE	SOIC	D	14	55	RoHS & Green	SN	Level-1-260C-UNLIM	0 to 70	LM319AM	Samples
LM319AMX/NOPB	ACTIVE	SOIC	D	14	2500	RoHS & Green	SN	Level-1-260C-UNLIM	0 to 70	LM319AM	Samples
LM319M	ACTIVE	SOIC	D	14	55	Non-RoHS & Green	Call TI	Level-1-235C-UNLIM	0 to 70	LM319M	Samples
LM319M/NOPB	ACTIVE	SOIC	D	14	55	RoHS & Green	SN	Level-1-260C-UNLIM	0 to 70	LM319M	Samples
LM319MX/NOPB	ACTIVE	SOIC	D	14	2500	RoHS & Green	SN	Level-1-260C-UNLIM	0 to 70	LM319M	Samples
LM319N/NOPB	ACTIVE	PDIP	N	14	25	RoHS & Green	Call TI SN	Level-1-NA-UNLIM	0 to 70	LM319N	Samples

(1) The marketing status values are defined as follows:

ACTIVE: Product device recommended for new designs.

LIFEBUY: TI has announced that the device will be discontinued, and a lifetime-buy period is in effect.

NRND: Not recommended for new designs. Device is in production to support existing customers, but TI does not recommend using this part in a new design.

PREVIEW: Device has been announced but is not in production. Samples may or may not be available.

OBSELETE: TI has discontinued the production of the device.

(2) **RoHS:** TI defines "RoHS" to mean semiconductor products that are compliant with the current EU RoHS requirements for all 10 RoHS substances, including the requirement that RoHS substance do not exceed 0.1% by weight in homogeneous materials. Where designed to be soldered at high temperatures, "RoHS" products are suitable for use in specified lead-free processes. TI may reference these types of products as "Pb-Free".

RoHS Exempt: TI defines "RoHS Exempt" to mean products that contain lead but are compliant with EU RoHS pursuant to a specific EU RoHS exemption.

Green: TI defines "Green" to mean the content of Chlorine (Cl) and Bromine (Br) based flame retardants meet JS709B low halogen requirements of <=1000ppm threshold. Antimony trioxide based flame retardants must also meet the <=1000ppm threshold requirement.

(3) MSL, Peak Temp. - The Moisture Sensitivity Level rating according to the JEDEC industry standard classifications, and peak solder temperature.

- (4) There may be additional marking, which relates to the logo, the lot trace code information, or the environmental category on the device.
- (5) Multiple Device Markings will be inside parentheses. Only one Device Marking contained in parentheses and separated by a "~" will appear on a device. If a line is indented then it is a continuation of the previous line and the two combined represent the entire Device Marking for that device.
- (6) Lead finish/Ball material - Orderable Devices may have multiple material finish options. Finish options are separated by a vertical ruled line. Lead finish/Ball material values may wrap to two lines if the finish value exceeds the maximum column width.

Important Information and Disclaimer:The information provided on this page represents TI's knowledge and belief as of the date that it is provided. TI bases its knowledge and belief on information provided by third parties, and makes no representation or warranty as to the accuracy of such information. Efforts are underway to better integrate information from third parties. TI has taken and continues to take reasonable steps to provide representative and accurate information but may not have conducted destructive testing or chemical analysis on incoming materials and chemicals. TI and TI suppliers consider certain information to be proprietary, and thus CAS numbers and other limited information may not be available for release.

In no event shall TI's liability arising out of such information exceed the total purchase price of the TI part(s) at issue in this document sold by TI to Customer on an annual basis.

TAPE AND REEL INFORMATION

QUADRANT ASSIGNMENTS FOR PIN 1 ORIENTATION IN TAPE



*All dimensions are nominal

Device	Package Type	Package Drawing	Pins	SPQ	Reel Diameter (mm)	Reel Width W1 (mm)	A0 (mm)	B0 (mm)	K0 (mm)	P1 (mm)	W (mm)	Pin1 Quadrant
LM319AMX/NOPB	SOIC	D	14	2500	330.0	16.4	6.5	9.35	2.3	8.0	16.0	Q1
LM319MX/NOPB	SOIC	D	14	2500	330.0	16.4	6.5	9.35	2.3	8.0	16.0	Q1

TAPE AND REEL BOX DIMENSIONS

*All dimensions are nominal

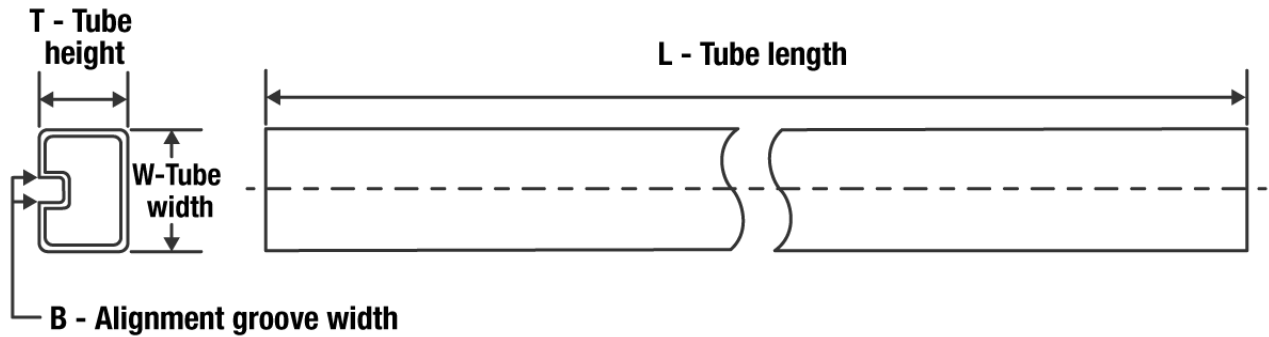
Device	Package Type	Package Drawing	Pins	SPQ	Length (mm)	Width (mm)	Height (mm)
LM319AMX/NOPB	SOIC	D	14	2500	367.0	367.0	35.0
LM319MX/NOPB	SOIC	D	14	2500	367.0	367.0	35.0

TUBE

*All dimensions are nominal

Device	Package Name	Package Type	Pins	SPQ	L (mm)	W (mm)	T (μm)	B (mm)
LM119J	J	CDIP	14	25	502	14	11938	4.32
LM319AM	D	SOIC	14	55	495	8	4064	3.05
LM319AM	D	SOIC	14	55	495	8	4064	3.05
LM319AM/NOPB	D	SOIC	14	55	495	8	4064	3.05
LM319M	D	SOIC	14	55	495	8	4064	3.05
LM319M	D	SOIC	14	55	495	8	4064	3.05
LM319M/NOPB	D	SOIC	14	55	495	8	4064	3.05
LM319N/NOPB	N	PDIP	14	25	502	14	11938	4.32

GENERIC PACKAGE VIEW

LME 10

TO-CAN - 5.72 mm max height

METAL CYLINDRICAL PACKAGE

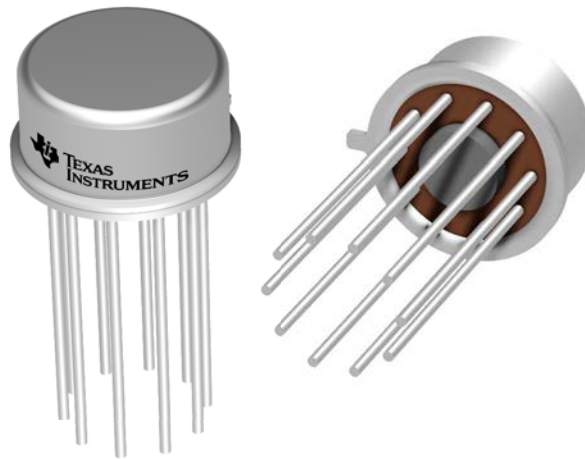

Images above are just a representation of the package family, actual package may vary.
Refer to the product data sheet for package details.

4202488/B

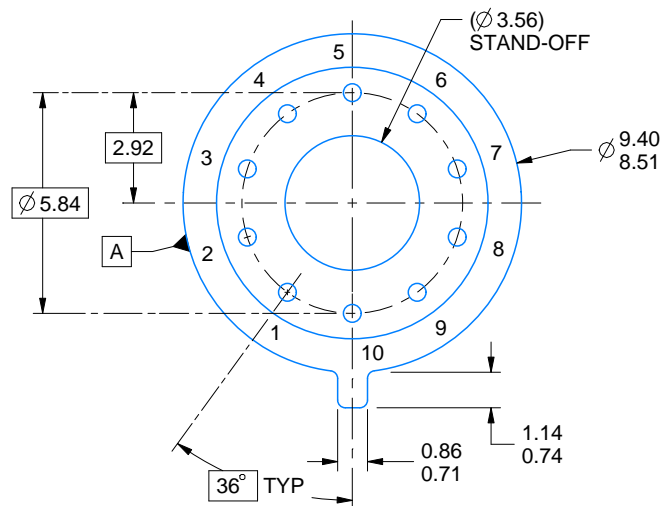
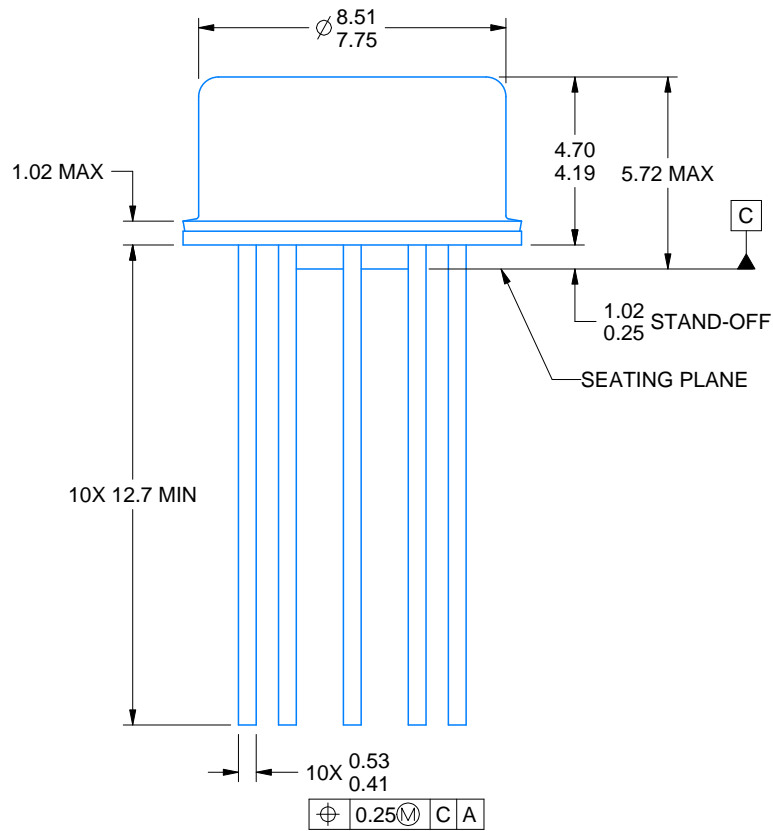

4220604/A 05/2017

NOTES:

1. All linear dimensions are in millimeters. Any dimensions in parenthesis are for reference only. Dimensioning and tolerancing per ASME Y14.5M.
2. This drawing is subject to change without notice.
3. Reference JEDEC registration MO-006/TO-100.

EXAMPLE BOARD LAYOUT

LME0010A

TO-CAN - 5.72 mm max height

METAL CYLINDRICAL PACKAGE

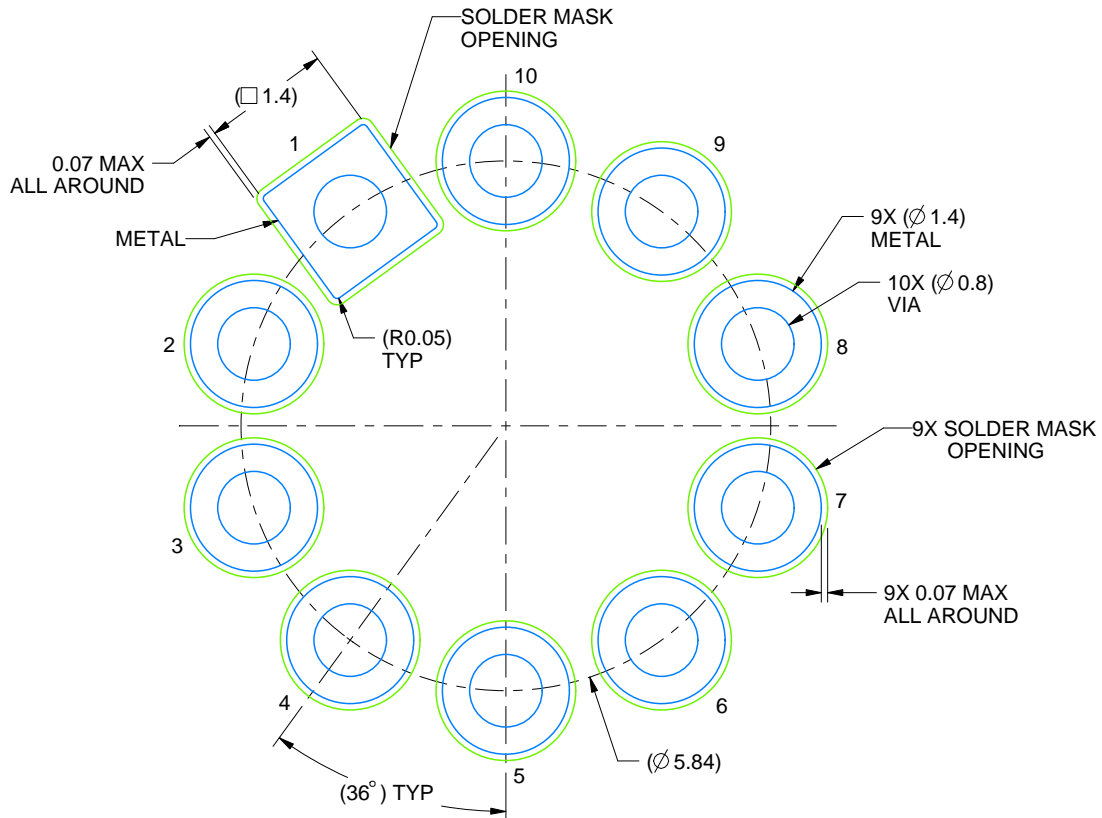

LAND PATTERN EXAMPLE
NON-SOLDER MASK DEFINED
SCALE: 12X

4220604/A 05/2017

J 14

GENERIC PACKAGE VIEW
CDIP - 5.08 mm max height
CERAMIC DUAL IN LINE PACKAGE



Images above are just a representation of the package family, actual package may vary.
Refer to the product data sheet for package details.

4040083-5/G

J0014A



PACKAGE OUTLINE

CDIP - 5.08 mm max height

CERAMIC DUAL IN LINE PACKAGE



4214771/A 05/2017

NOTES:

1. All controlling linear dimensions are in inches. Dimensions in brackets are in millimeters. Any dimension in brackets or parenthesis are for reference only. Dimensioning and tolerancing per ASME Y14.5M.
2. This drawing is subject to change without notice.
3. This package is hermetically sealed with a ceramic lid using glass frit.
4. Index point is provided on cap for terminal identification only and on press ceramic glass frit seal only.
5. Falls within MIL-STD-1835 and GDIP1-T14.

EXAMPLE BOARD LAYOUT

J0014A

CDIP - 5.08 mm max height

CERAMIC DUAL IN LINE PACKAGE



LAND PATTERN EXAMPLE
NON-SOLDER MASK DEFINED
SCALE: 5X



4214771/A 05/2017

D (R-PDSO-G14)

PLASTIC SMALL OUTLINE



- NOTES:
- A. All linear dimensions are in inches (millimeters).
 - B. This drawing is subject to change without notice.
 -  Body length does not include mold flash, protrusions, or gate burrs. Mold flash, protrusions, or gate burrs shall not exceed 0.006 (0,15) each side.
 -  Body width does not include interlead flash. Interlead flash shall not exceed 0.017 (0,43) each side.
 - E. Reference JEDEC MS-012 variation AB.

D (R-PDSO-G14)

PLASTIC SMALL OUTLINE



- NOTES:
- A. All linear dimensions are in millimeters.
 - B. This drawing is subject to change without notice.
 - C. Publication IPC-7351 is recommended for alternate designs.
 - D. Laser cutting apertures with trapezoidal walls and also rounding corners will offer better paste release. Customers should contact their board assembly site for stencil design recommendations. Refer to IPC-7525 for other stencil recommendations.
 - E. Customers should contact their board fabrication site for solder mask tolerances between and around signal pads.

N (R-PDIP-T**)

PLASTIC DUAL-IN-LINE PACKAGE

16 PINS SHOWN



- NOTES:
- A. All linear dimensions are in inches (millimeters).
 - B. This drawing is subject to change without notice.
 - Falls within JEDEC MS-001, except 18 and 20 pin minimum body length (Dim A).
 - The 20 pin end lead shoulder width is a vendor option, either half or full width.

IMPORTANT NOTICE AND DISCLAIMER

TI PROVIDES TECHNICAL AND RELIABILITY DATA (INCLUDING DATA SHEETS), DESIGN RESOURCES (INCLUDING REFERENCE DESIGNS), APPLICATION OR OTHER DESIGN ADVICE, WEB TOOLS, SAFETY INFORMATION, AND OTHER RESOURCES "AS IS" AND WITH ALL FAULTS, AND DISCLAIMS ALL WARRANTIES, EXPRESS AND IMPLIED, INCLUDING WITHOUT LIMITATION ANY IMPLIED WARRANTIES OF MERCHANTABILITY, FITNESS FOR A PARTICULAR PURPOSE OR NON-INFRINGEMENT OF THIRD PARTY INTELLECTUAL PROPERTY RIGHTS.

These resources are intended for skilled developers designing with TI products. You are solely responsible for (1) selecting the appropriate TI products for your application, (2) designing, validating and testing your application, and (3) ensuring your application meets applicable standards, and any other safety, security, regulatory or other requirements.

These resources are subject to change without notice. TI grants you permission to use these resources only for development of an application that uses the TI products described in the resource. Other reproduction and display of these resources is prohibited. No license is granted to any other TI intellectual property right or to any third party intellectual property right. TI disclaims responsibility for, and you will fully indemnify TI and its representatives against, any claims, damages, costs, losses, and liabilities arising out of your use of these resources.

TI's products are provided subject to [TI's Terms of Sale](#) or other applicable terms available either on ti.com or provided in conjunction with such TI products. TI's provision of these resources does not expand or otherwise alter TI's applicable warranties or warranty disclaimers for TI products.

TI objects to and rejects any additional or different terms you may have proposed.

Mailing Address: Texas Instruments, Post Office Box 655303, Dallas, Texas 75265
Copyright © 2022, Texas Instruments Incorporated