

MCR08B, MCR08M

Surface Mount – 600V - 800V

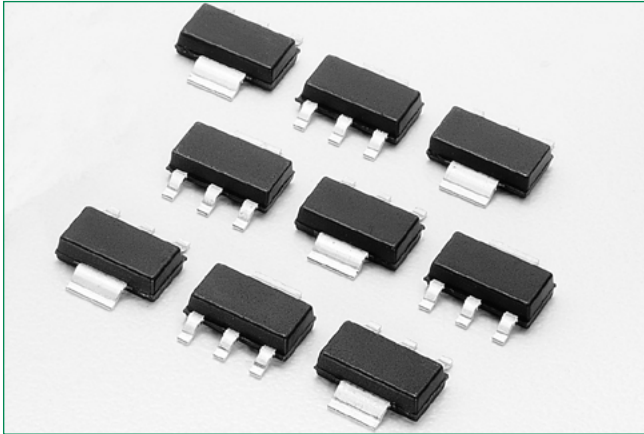

Description

PNPN devices designed for line powered consumer applications such as relay and lamp drivers, small motor controls, gate drivers for larger thyristors, and sensing and detection circuits. Supplied in surface mount package for use in automated manufacturing.

Features

- Sensitive Gate Trigger Current
- Blocking Voltage to 600 V
- Glass Passivated Surface for Reliability and Uniformity
- Surface Mount Package
- Lead-free and RoHS-compliant

Functional Diagram

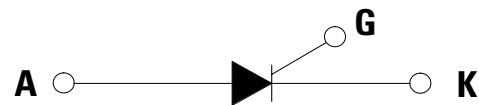

Pin Out

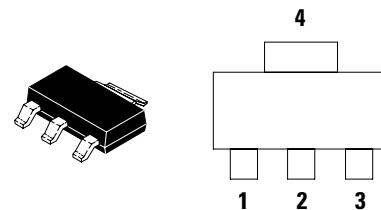

Additional Information



Resources



Accessories



Samples

MCR08B, MCR08M

Surface Mount – 600V - 800V

Maximum Ratings ($T_J = 25^\circ\text{C}$ unless otherwise noted)

Rating	Symbol	Value	Unit
Peak Repetitive Off-State Voltage (Note 1) (Sine Wave, $R_{GK}=1\text{ k}\Omega$, $T_J = 25$ to 110°C)	V_{DRM} V_{RRM}	200 600	V
On-State RMS Current (All Conduction Angles; $T_C = 80^\circ\text{C}$)	$I_{T(RMS)}$	0.8	A
Peak Non-Repetitive Surge Current (1/2 Cycle Sine Wave, 60 Hz, $T_C = 25^\circ\text{C}$)	I_{TSM}	8.0	A
Circuit Fusing Consideration ($t = 8.3\text{ ms}$)	I^2t	0.4	A^2sec
Forward Peak Gate Power ($T_C = 80^\circ\text{C}$, $t = 1.0\text{ }\mu\text{s}$)	P_{GM}	0.1	W
Average Gate Power ($t = 8.3\text{ ms}$, $T_C = 80^\circ\text{C}$)	$P_{GM(AV)}$	0.01	W
Operating Junction Temperature Range	T_J	-40 to +110	$^\circ\text{C}$
Storage Temperature Range	T_{stg}	-40 to +150	$^\circ\text{C}$

Thermal Characteristics

Rating	Symbol	Value	Unit
Thermal Resistance, Junction-to-Ambient PCB Mounted per Figure 1	$R_{\theta JA}$	156	$^\circ\text{C}/\text{W}$
Thermal Resistance, Junction-to-Tab Measured on Anode Tab Adjacent to Epoxy	$R_{\theta JA}$	25	$^\circ\text{C}/\text{W}$
Maximum Device Temperature for Soldering Purposes (for 10 Seconds Maximum)	T_L	260	$^\circ\text{C}$

Stresses exceeding Maximum Ratings may damage the device. Maximum Ratings are stress ratings only. Functional operation above the Recommended Operating Conditions is not implied. Extended exposure to stresses above the Recommended Operating Conditions may affect device reliability.

1. V_{DRM} and V_{RRM} for all types can be applied on a continuous basis. Ratings apply for zero or negative gate voltage; however, positive gate voltage shall not be applied concurrent with negative potential on the anode. Blocking voltages shall not be tested with a constant current source such that the voltage ratings of the devices are exceeded.

Electrical Characteristics - OFF ($T_J = 25^\circ\text{C}$ unless otherwise noted ; Electricals apply in both directions)

Characteristic	Symbol	Min	Typ	Max	Unit
Peak Repetitive Forward or Reverse Blocking Current (Note 3) ($V_{AK} = \text{Rated } V_{DRM} \text{ or } V_{RRM}$, $R_{GK} = 1\text{ k}\Omega$)	I_{DRM}	-	-	10	μA
	I_{RRM}	-	-	200	μA

Electrical Characteristics - ON ($T_J = 25^\circ\text{C}$ unless otherwise noted; Electricals apply in both directions)

Characteristic	Symbol	Min	Typ	Max	Unit
Peak Forward On-State Voltage (Note 2) ($I_T = 1.0\text{ A Peak}$)	V_{TM}	-	-	1.7	V
Gate Trigger Current (Continuous dc) (Note 4) ($V_{AK} = 12\text{ Vdc}$, $R_L = 100\text{ }\Omega$)	I_{GT}	-	-	200	μA
Holding Current (Note 3) ($V_{AK} = 12\text{ Vdc}$, Initiating Current = 20 mA)	I_H	-	-	5.0	mA
Gate Trigger Voltage (Continuous dc) ($V_D = 12\text{ V}$, $R_L = 100\text{ }\Omega$)	V_{GT}	-	-	0.8	V
Turn-On Time ($V_{AK} = 12\text{ Vdc}$, $I_{TM} = 5\text{ Adc}$, $I_{GT} = 5\text{ mA}$)	t_{gt}	-	1.25	-	μs

2. Pulse Test: Pulse Width $\leq 300\text{ }\mu\text{s}$, Duty Cycle $\leq 2\%$.

3. $R_{GK} = 1000\text{ }\Omega$ is included in measurement.

4. R_{GK} is not included in measurement.

Dynamic Characteristics

Characteristic	Symbol	Min	Typ	Max	Unit
Critical Rate-of-Rise of Off State Voltage ($V_{pk} = \text{Rated } V_{DRM}$, $T_C = 110^\circ\text{C}$, $R_{GK} = 1\text{ k}\Omega$, Exponential Method)	dv/dt	10	-	-	$\text{V}/\mu\text{s}$

MCR08B, MCR08M

Surface Mount – 600V - 800V

Voltage Current Characteristic of SCR

Symbol	Parameter
V_{DRM}	Peak Repetitive Forward Off State Voltage
I_{DRM}	Peak Forward Blocking Current
V_{RRM}	Peak Repetitive Reverse Off State Voltage
I_{RRM}	Peak Reverse Blocking Current
V_{TM}	Maximum On State Voltage
I_H	Holding Current

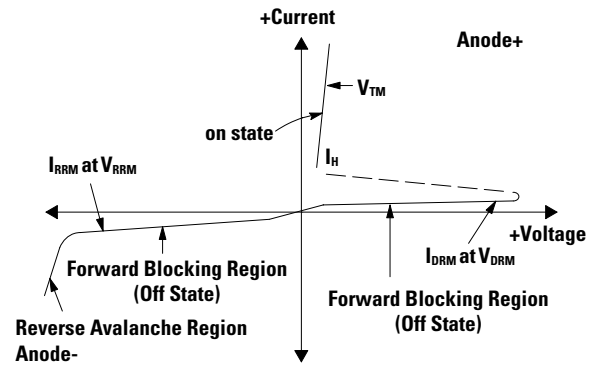
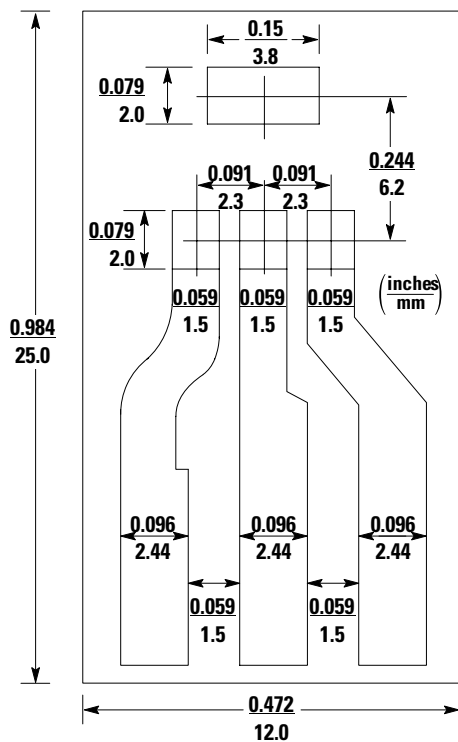

Figure 1.

PCB for Thermal Impedance and Power Testing of SOT-223



Board mounted vertically cinch 8840 edge connector.
 Board Thickness = 65Mil.
 Foil Thickness = 2.5Mil.
 Material: G10 Fiberglass Base Epoxy

MCR08B, MCR08M

Surface Mount – 600V - 800V

Figure 2.
On-State Characteristics

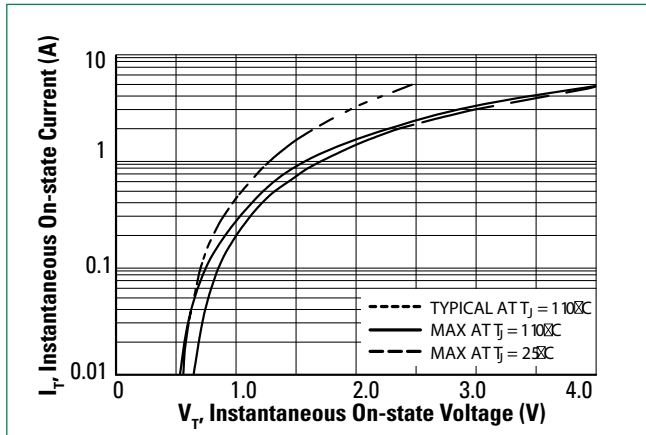

Figure 3.
Junction to Ambient Thermal Resistance vs Copper Tab Area

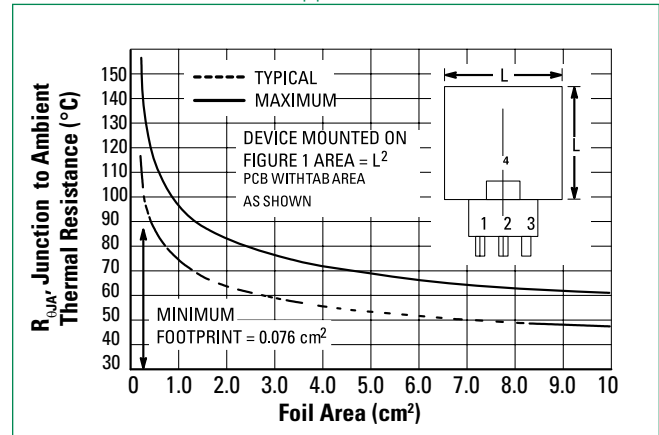

Figure 4.
Current Derating, Minimum Pad Size Reference:
Ambient Temperature

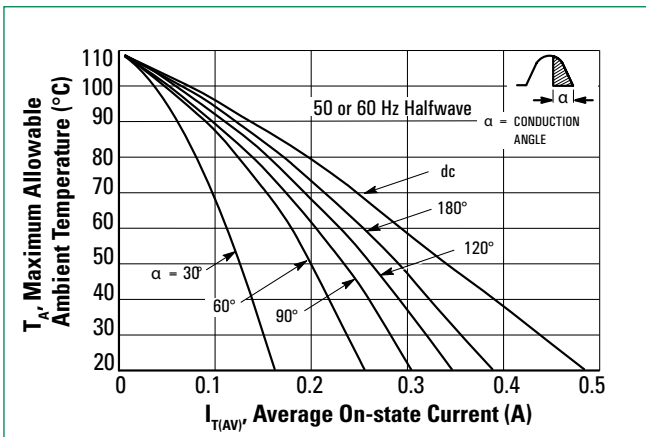

Figure 5.
Current Derating, 1.0 cm Square Pad Reference:
Ambient Temperature

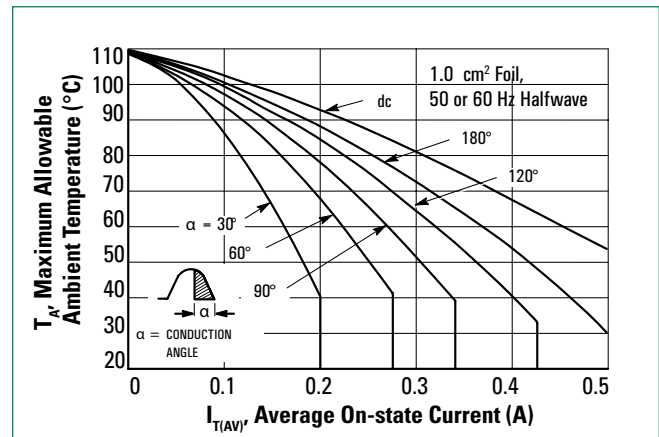

Figure 6.
Current Derating, 2.0 cm Square Pad Reference:
Ambient Temperature

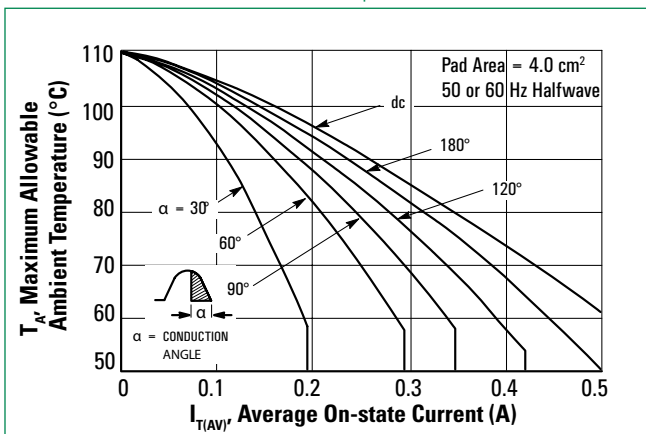
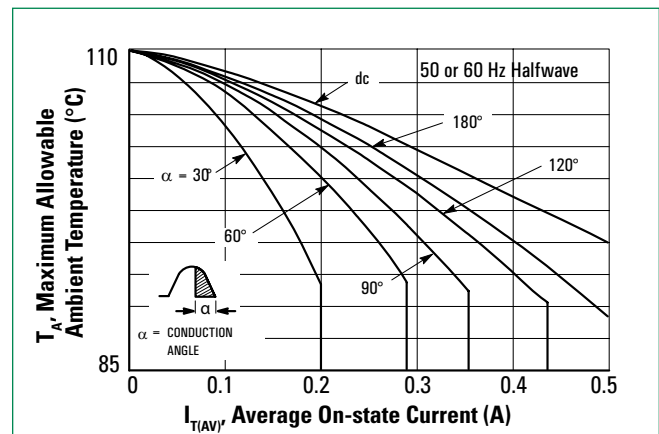

Figure 7.
Current Derating Reference: Anode Tab



MCR08B, MCR08M

Surface Mount – 600V - 800V

Figure 8.
Power Dissipation

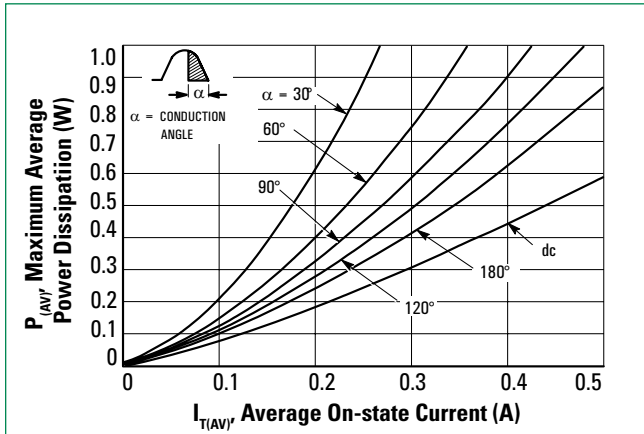

Figure 9.

Thermal Response Device Mounted on Figure 1 Printed Circuit Board

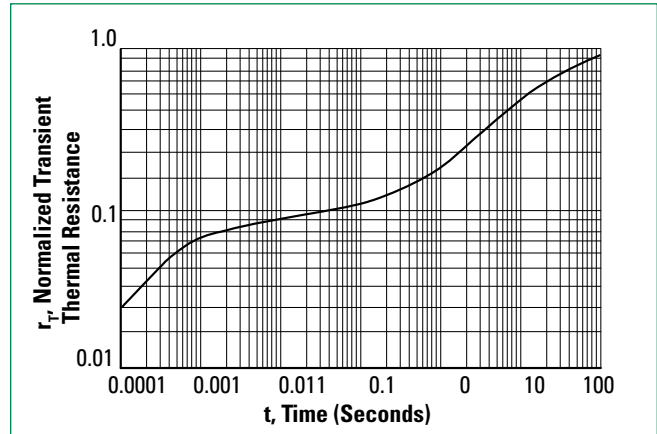

Figure 10.

Typical Gate Trigger Voltage vs Junction Temperature

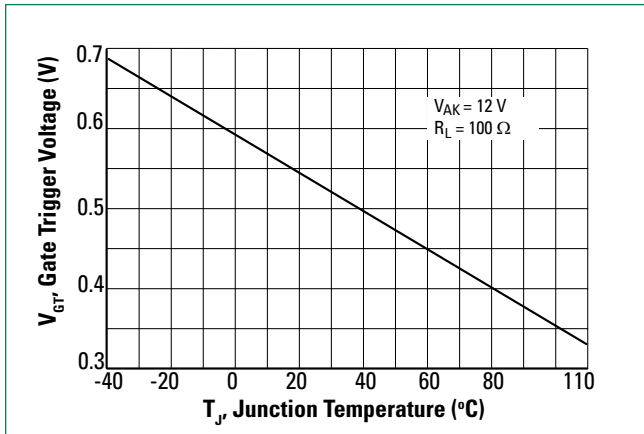

Figure 11.

Typical Normalized Holding Current vs Junction Temperature

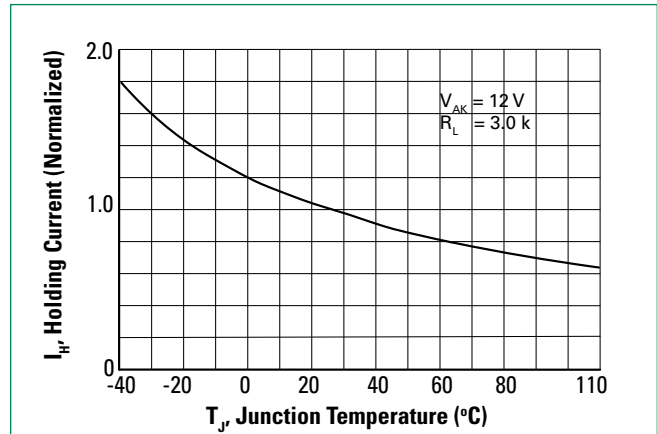

Figure 12.

Typical Range of VGT versus Measured IGT

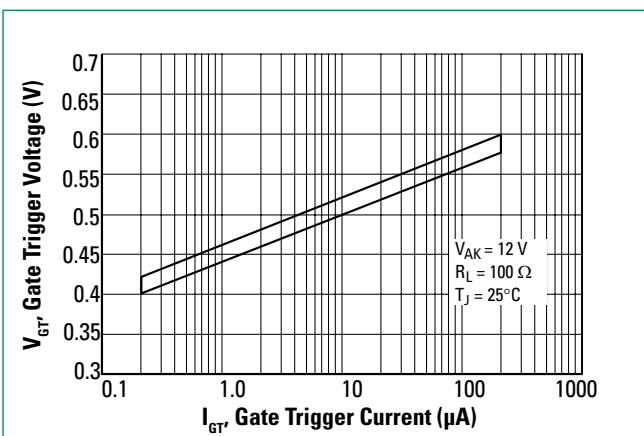
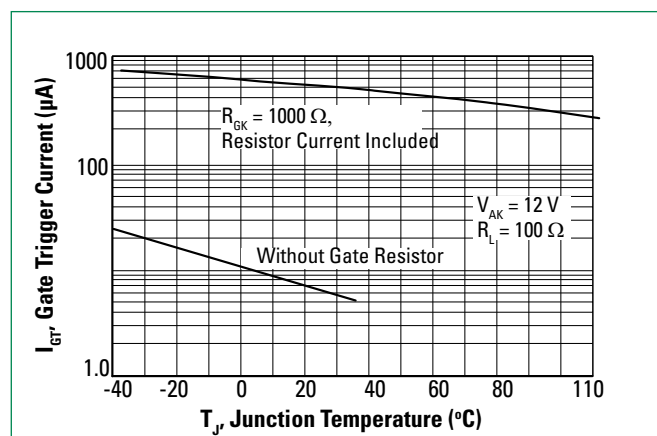

Figure 13.

Typical Gate Trigger Current vs Junction Temperature



MCR08B, MCR08M

Surface Mount – 600V - 800V

Figure 14.

Holding Current Range vs Gate-Cathode Resistance

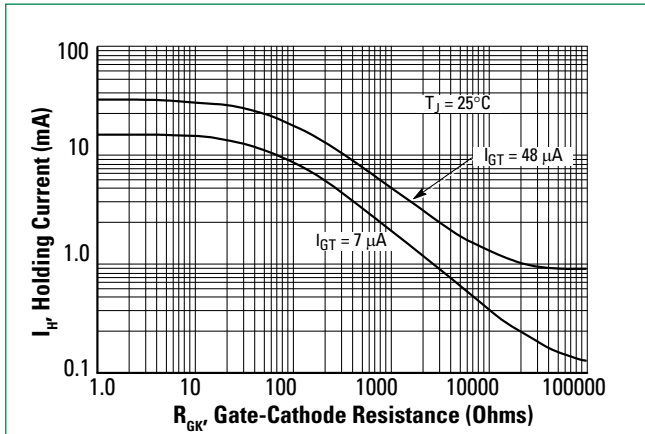

Figure 15.

Exponential Static dv/dt vs. Junction Temperature and Gate-Cathode Termination Resistance

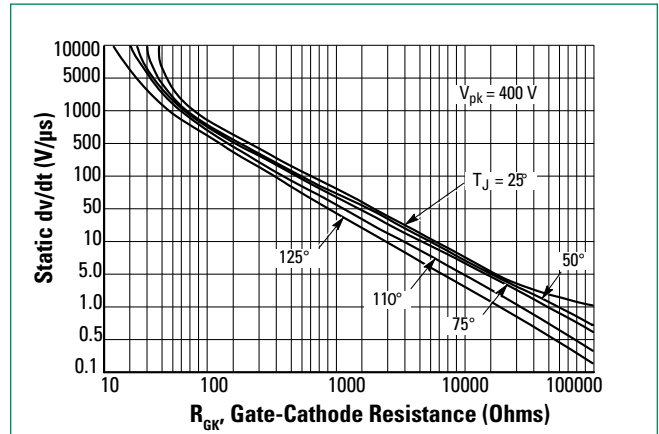

Figure 16.

Exponential Static dv/dt vs Peak Voltage and Gate-Cathode Termination Resistance

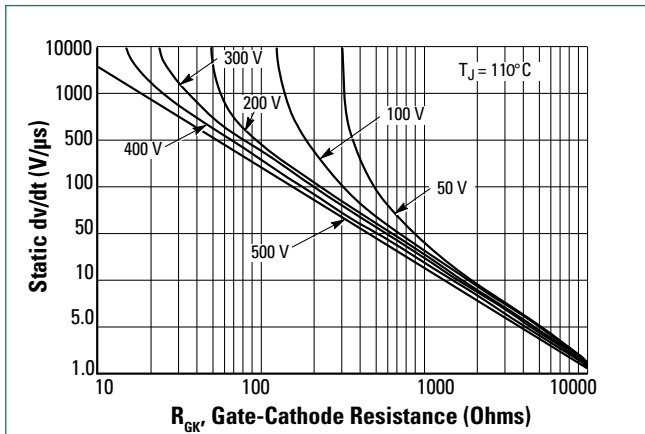

Figure 17.

Exponential Static dv/dt vs Gate-Cathode Capacitance and Resistance

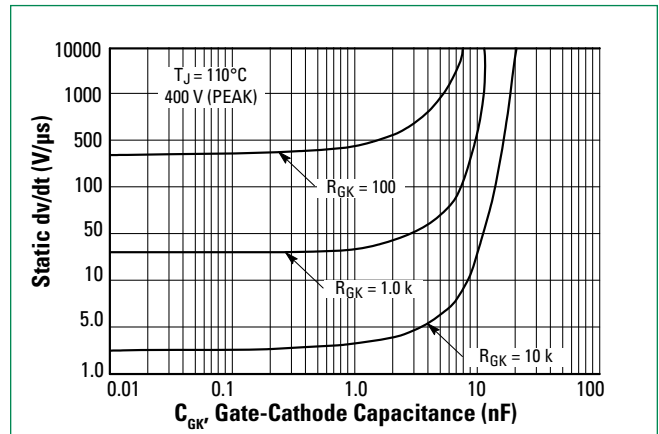
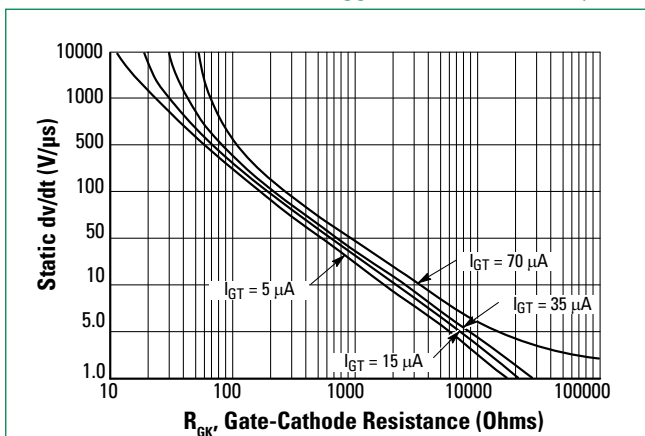

Figure 18.

Exponential Static dv/dt vs Gate-Cathode Termination Resistance and Product Trigger Current Sensitivity



MCR08B, MCR08M

Surface Mount – 600V - 800V

Dimensions

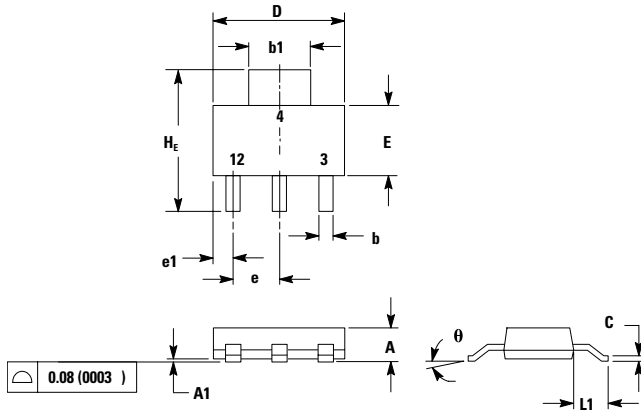

Soldering Footprint

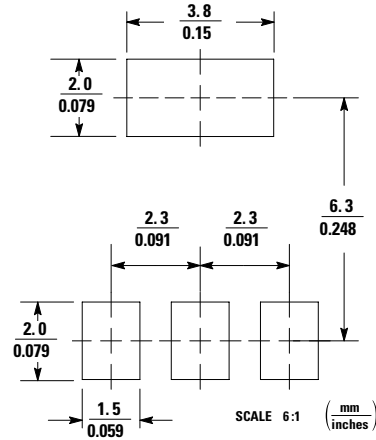

Dim	Millimeters			Inches		
	Min	Nom	Max	Min	Nom	Max
A	1.50	1.63	1.75	0.060	0.064	0.068
A1	0.02	0.06	0.10	0.001	0.002	0.004
b	0.60	0.75	0.89	0.024	0.030	0.035
b1	2.90	3.06	3.20	0.115	0.121	0.126
c	0.24	0.29	0.35	0.009	0.012	0.014
D	6.30	6.50	6.70	0.249	0.256	0.263
E	3.30	3.50	3.70	0.130	0.138	0.145
e	2.20	2.30	2.40	0.087	0.091	0.094
e1	0.85	0.94	1.05	0.033	0.037	0.041
L1	1.50	1.75	2.00	0.060	0.069	0.078
H _E	6.70	7.00	7.30	0.264	0.276	0.287
θ	0°	–	10°	0°	–	10°

1. Dimensions and Tolerancing per Ansi Y14.5M. 1982.
 2. Controlling Dimension: Inch.

Part Marking System

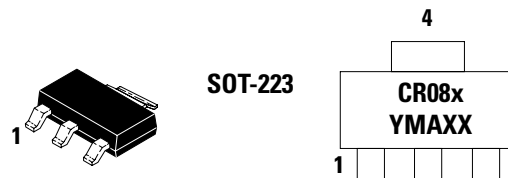

CR08x = Device Code
 x = B or M
 Y = Year
 M = Month
 A = Assembly Location
 XX = Series Number

Ordering Information

Device	Package	Shipping
MCR08BT1G	SOT-223 (Pb-Free)	1000/Tape & Reel
MCR08MT1G	SOT-223 (Pb-Free)	1000/Tape & Reel

Pin Assignment

Pin	Assignment
1	Cathode
2	Anode
3	Gate
4	Anode

Disclaimer Notice - Information furnished is believed to be accurate and reliable. However, users should independently evaluate the suitability of and test each product selected for their own applications. Littelfuse products are not designed for, and may not be used in, all applications. Read complete Disclaimer Notice at: www.littelfuse.com/disclaimer-electronics