

MAXIM

3-Pin Silicon Oscillator

MAX7381

General Description

The MAX7381 is a silicon oscillator intended as a low-cost improvement to ceramic resonators, crystals, and crystal oscillator modules as the clock source for microcontrollers and UARTs in 3V, 3.3V, and 5V applications.

The MAX7381 is an integrated oscillator, supplied at specific frequencies, just like crystals and resonators, and with a rail-to-rail, 50%, duty-cycle square-wave output. The oscillator frequency is generated directly without the use of a phase-locked loop (PLL). No additional components are required for setting or adjusting the frequency.

Unlike typical crystal and ceramic resonator oscillator circuits, the MAX7381 is resistant to vibration and EMI. The high output-drive current and absence of high-impedance nodes make the oscillator invulnerable to dirty or humid operating conditions. With a wide operating temperature range as standard, the oscillator is a good choice for demanding appliance and automotive environments. The MAX7381 is available with frequencies in the 10MHz to 16MHz range.

The MAX7381 is offered in a space-saving 3-pin SC70 package. All ICs are guaranteed to operate over the -55°C to +135°C temperature range and specified from the -40°C to +125°C temperature range.

Applications

White Goods
Automotive
Appliances and Controls
Handheld Products
Portable Equipment
Microcontroller Systems

Typical Operating Circuit

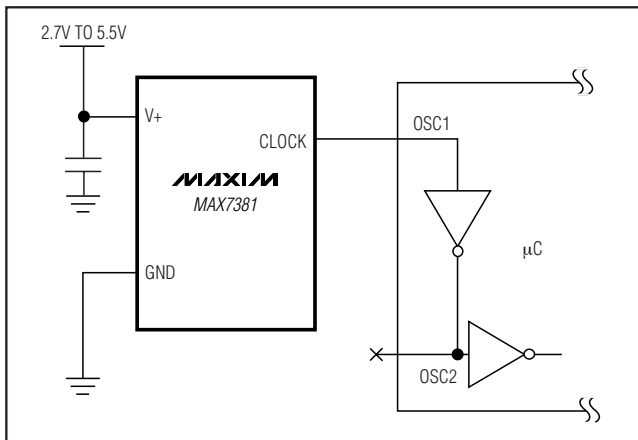

Features

- ◆ 2.7V to 5.5V Operation
- ◆ Factory-Trimmed Oscillator (10MHz to 16MHz)
- ◆ No External Components Required
- ◆ ±10mA Output-Drive Current
- ◆ 2% Initial Accuracy
- ◆ ±100ppm/°C Temperature Drift
- ◆ Fast Startup Time: 5µs
- ◆ 40% to 60% Maximum Duty Cycle
- ◆ 5ns Output Rise/Fall Time
- ◆ Very-Low-EMI Susceptibility (No High-Impedance Nodes)
- ◆ No PLL
- ◆ Low Jitter: 180psp-p at 16MHz
- ◆ -40°C to +125°C Temperature Range

Ordering Information

PART	TEMP RANGE	PIN-PACKAGE
MAX7381AXR106-T	-40°C to +125°C	3 SC70-3
MAX7381AXR126-T	-40°C to +125°C	3 SC70-3
MAX7381AXR146-T	-40°C to +125°C	3 SC70-3
MAX7381AXR166-T	-40°C to +125°C	3 SC70-3

The MAX7381 is available in factory-set frequencies from 10MHz to 16MHz. There are four standard versions (10MHz, 12MHz, 14MHz, and 16MHz, shown in the Selector Guide) with a required order increment of 2.5K. Nonstandard frequencies are also available with a required order increment of 10K. For nonstandard versions, contact factory for availability and ordering information. All versions are available in tape and reel only.

Refer to the MAX7375 data sheet for output frequencies below 10MHz.

Selector Guide appears at end of data sheet.

3-Pin Silicon Oscillator

ABSOLUTE MAXIMUM RATINGS

V+ to GND-0.3V to +6.0V
 CLK to GND.....-0.3V to (V+ + 0.3V)
 CLK Current±50mA
 Continuous Power Dissipation (T_A = + 70°C)
 3-Pin SC70 (derate 2.9mW/°C over +70°C).....235.3mW

Functional Temperature Range-55°C to +135°C
 Junction Temperature+150°C
 Storage Temperature Range-65°C to +150°C
 Lead Temperature (soldering, 10s)+300°C

Stresses beyond those listed under "Absolute Maximum Ratings" may cause permanent damage to the device. These are stress ratings only, and functional operation of the device at these or any other conditions beyond those indicated in the operational sections of the specifications is not implied. Exposure to absolute maximum rating conditions for extended periods may affect device reliability.

ELECTRICAL CHARACTERISTICS

(V+ = 2.7V to 5.5V, T_A = -40°C to +125°C, unless otherwise noted. Typical values are at V+ = 5V, T_A = +25°C, unless otherwise noted.) (Note 1)

PARAMETER	SYMBOL	CONDITIONS	MIN	TYP	MAX	UNITS	
Operating Supply Voltage	V+		2.7		5.5	V	
Operating Supply Current	I+	MAX7381AXR126		3.7	4.75	mA	
		MAX7381AXR166		4.8	6.50		
Output High Voltage	V _{OH}	V+ ≥ 2.7V, I _{SOURCE} = 2.5mA	V+ - 0.4			V	
		V+ ≥ 4.5V, I _{SOURCE} = 9mA	V+ - 0.4				
Output Low Voltage	V _{OL}	V+ ≥ 2.7V, I _{SINK} = 10mA			0.4	V	
		V+ ≥ 4.5V, I _{SINK} = 20mA			0.4		
On-Resistance		V _{IN} = 3V (typ value at T _A = +25°C)		0.11	0.17	Ω	
		V _{IN} = 5V (typ value at T _A = +25°C)		0.095	0.15		
Initial CLOCK Frequency (Note 2)	f _{CLOCK}	V+ = 5.0V, T _A = +25°C	MAX7381AXR_ _ _	-2%		+2%	MHz
		V+ = 2.7V to 5.5V, T _A = +25°C	MAX7381AXR_ _ _	-5%		+3%	
CLOCK Frequency Temperature Sensitivity		T _A = -40°C to +125°C, (Note 3)	-350	100	+300	ppm/°C	
Duty Cycle		(Note 3)	40	50	60	%	
Output Jitter		Observation for 20s using a 12GHz oscilloscope (MAX7381AXR166)		180		psp-p	
Output Rise Time	t _R			5		ns	
Output Fall Time	t _F			5		ns	
Startup Time				5		μs	

Note 1: All parameters tested at T_A = +25°C. Specifications over temperature are guaranteed by design and characterization.

Note 2: Typical frequencies are nominal values.

Note 3: Guaranteed by design and characterization. Not production tested.

3-Pin Silicon Oscillator

MAX7381

Typical Operating Characteristics

($V_+ = 5V$, $C_L = 10pF$, 16MHz output, $T_A = +25^\circ C$, unless otherwise noted.)

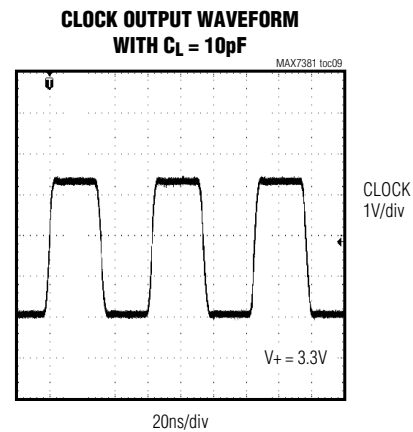
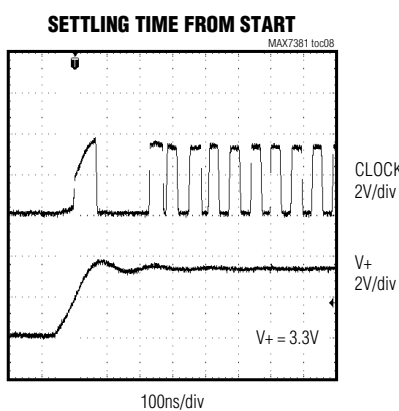
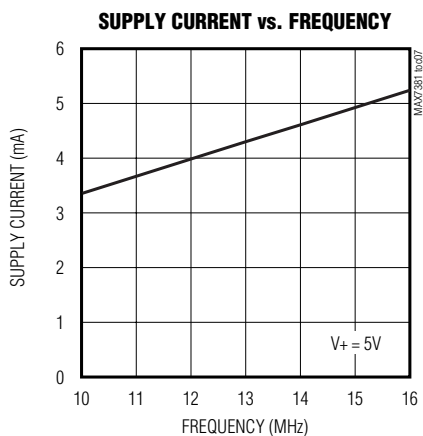
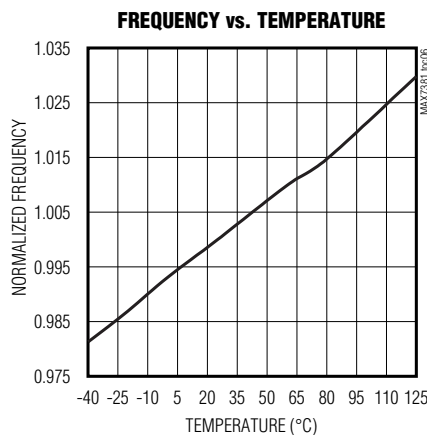
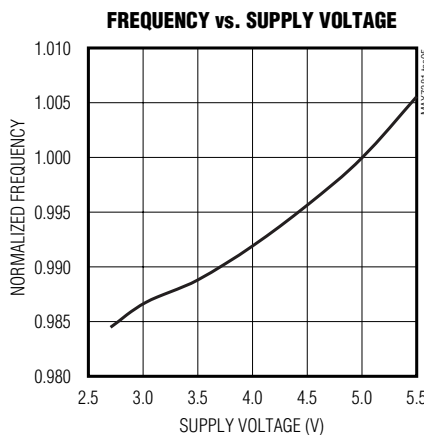
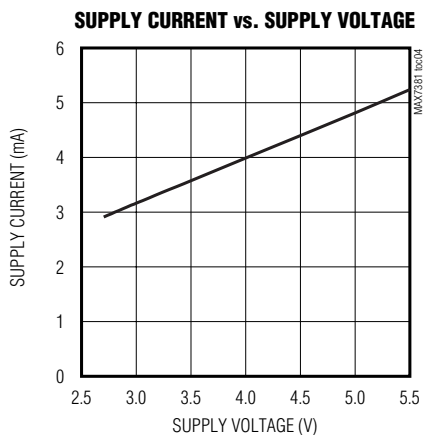
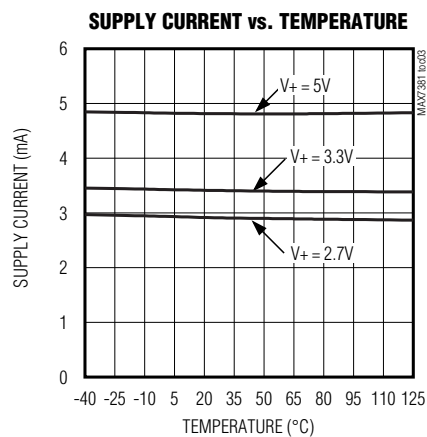
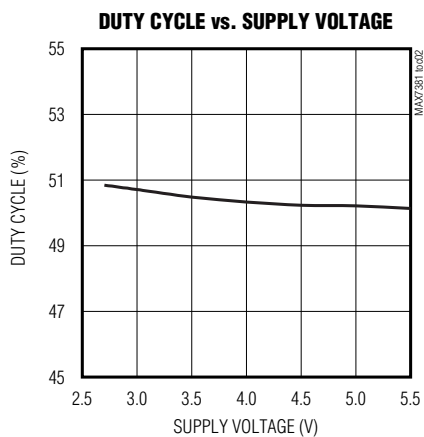
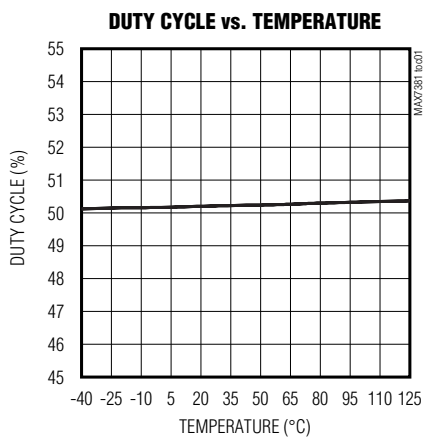

3-Pin Silicon Oscillator

Typical Operating Characteristics (continued)

($V_+ = 5V$, $C_L = 10pF$, 16MHz output, $T_A = +25^\circ C$, unless otherwise noted.)

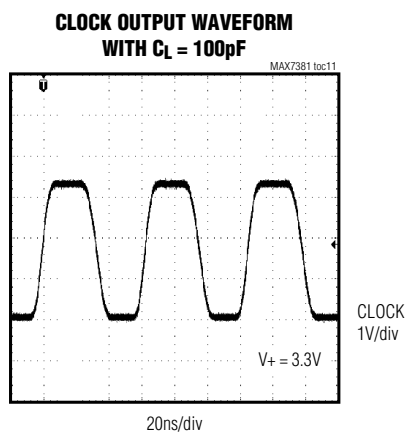
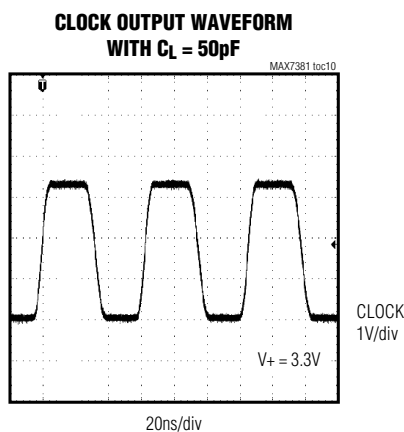

Detailed Description

The MAX7381 is a replacement for ceramic resonators, crystals, and crystal-oscillator modules as the clock source for microcontrollers and UARTs in 3V, 3.3V, and 5V applications. The MAX7381 is an integrated oscillator, supplied at specific frequencies just like crystals and resonators. A variety of popular standard frequencies are available. No external components are required for setting or adjusting the frequency.

Supply Voltages

The MAX7381 has been designed for use in systems with nominal supply voltages of 3V, 3.3V, or 5V and is specified for operation with supply voltages in the 2.7V to 5.5V range. Operation outside this range is not guaranteed. See the *Absolute Maximum Ratings* for limit values of power-supply and pin voltages.

Oscillator

The clock output is a push-pull configuration and is capable of driving a ground-connected $1k\Omega$ load or a positive-supply-connected 500Ω load to within 400mV of either supply rail. The clock output remains stable over the full operating voltage range. A typical startup characteristic is shown in the *Typical Operating Characteristics* section.

Output Jitter

The MAX7381's jitter performance is given in the *Electrical Characteristics* table as a peak-to-peak value obtained by observing the output of the MAX7381 for 20s with a 500MHz oscilloscope. Jitter measurements

Pin Description

PIN	NAME	FUNCTION
1	V_+	Positive Supply Voltage. Bypass V_+ to GND with a $0.1\mu F$ surface-mount ceramic capacitor.
2	CLOCK	Clock Output. CLOCK is a push-pull output.
3	GND	Ground

are approximately proportional to the period of the output frequency of the device.

The jitter performance of all clock sources degrades in the presence of mechanical and electrical interference. The MAX7381 is relatively immune to vibration, shock, and EMI influences, and thus provides a considerably more robust clock source than crystal- or ceramic-resonator-based oscillator circuits.

Applications Information

Interfacing to a Microcontroller Clock Input

The MAX7381 clock output is a push-pull, CMOS, logic output, which directly drives any microprocessor (μP) or microcontroller (μC) clock input. There are no impedance-matching issues when using the MAX7381. Operate the MAX7381 and microcontroller (or other clock-input device) from the same supply voltage. Refer to the microcontroller data sheet for clock-input compatibility with external clock signals.

3-Pin Silicon Oscillator

The MAX7381 requires no biasing components or load capacitance. When using the MAX7381 to retrofit a crystal oscillator, remove all biasing components from the oscillator input.

Startup Performance

The MAX7381 oscillator output stabilizes within a few cycles of operation after V+ rises to a sufficient voltage to start the oscillator, typically 1.65V at +25°C. Use a reset or similar voltage-detection circuit to disable devices connected to the MAX7381 until 20µs after the voltage on V+ has risen above 2.7V.

Power-Supply Considerations

The MAX7381 operates with power-supply voltages in the 2.7V to 5.5V range. Power-supply decoupling is needed to maintain the power-supply rejection performance of the MAX7381. Use a 0.1µF surface-mount ceramic capacitor connected between V+ and GND and mounted as close to the device as possible. If possible, mount the MAX7381 close to the microcontroller's decoupling capacitor so that additional decoupling is not required.

A larger value bypass capacitor is recommended if the MAX7381 is driving a large capacitive load. Use a bypass capacitor value of at least 1000 times the output-load capacitance.

Chip Information

PROCESS: BiCMOS

Selector Guide

PART	FREQUENCY (MHz)	TOP MARK
MAX7381AXR106	10	APE
MAX7381AXR126	12	APG
MAX7381AXR146	14	ARC
MAX7381AXR166	16	APH

Pin Configuration

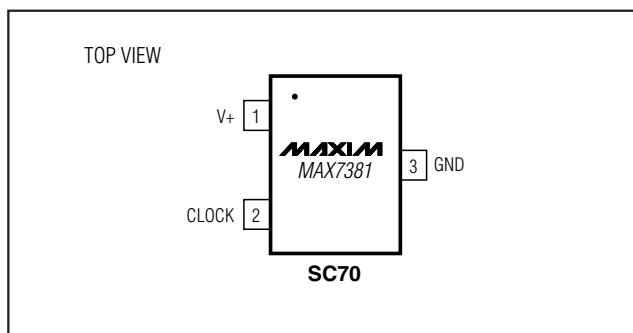

3-Pin Silicon Oscillator

Package Information

(The package drawing(s) in this data sheet may not reflect the most current specifications. For the latest package outline information, go to www.maxim-ic.com/packages.)

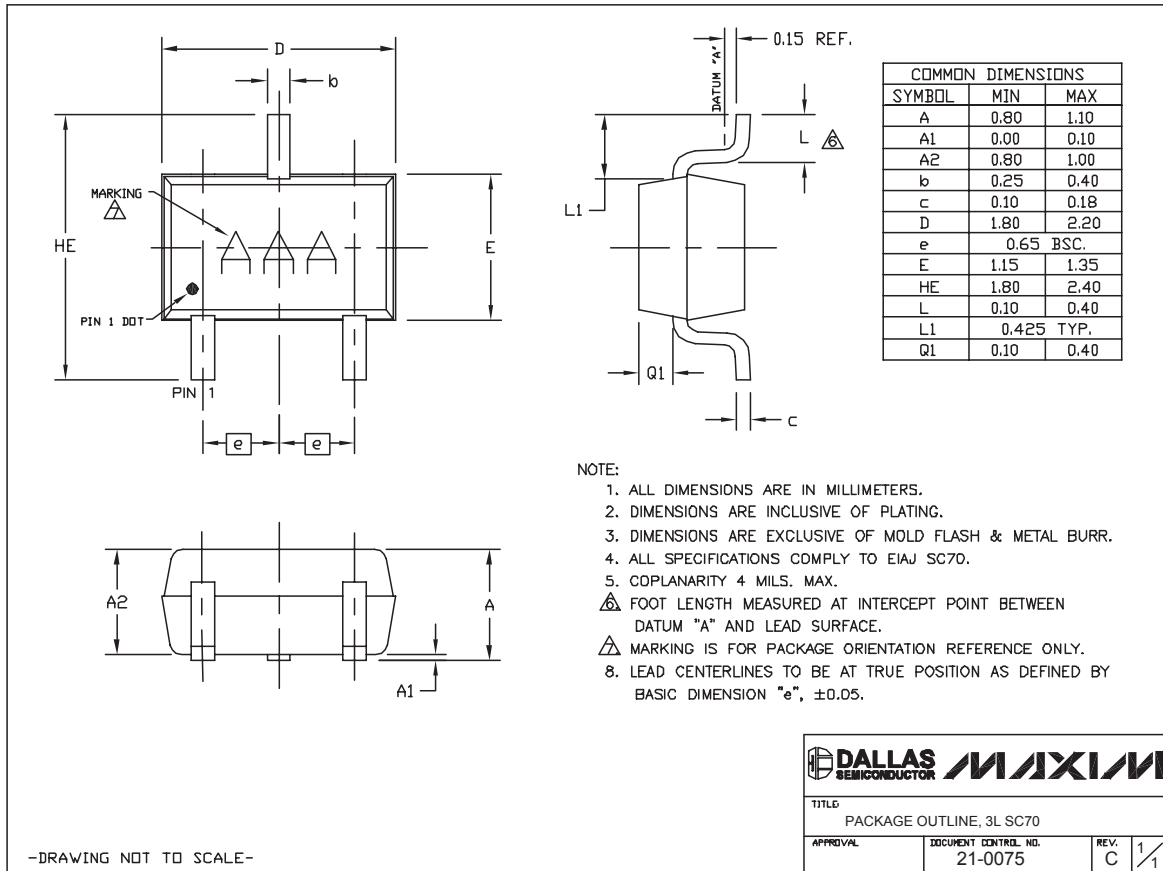

Maxim cannot assume responsibility for use of any circuitry other than circuitry entirely embodied in a Maxim product. No circuit patent licenses are implied. Maxim reserves the right to change the circuitry and specifications without notice at any time.

Maxim Integrated Products, 120 San Gabriel Drive, Sunnyvale, CA 94086 408-737-7600 6