

## 175°C, Wide Supply 2.5V Precision Voltage Reference

### FEATURES

- 2.5V Output Voltage
- 100% Tested at 175°C
- Total Error < 1% Over -40°C to 175°C
- Low Thermal Hysteresis: 30ppm Over -40°C to 175°C
- Wide Supply Range to 36V
- Long Term Drift: 50ppm/ $\sqrt{\text{kHr}}$
- Line Regulation (Up to 36V): 30ppm/V Max at 175°C
- Low Dropout Voltage: 120mV Max at 175°C
- Sources 3mA and Sinks 10mA at 175°C
- Load Regulation 50ppm/mA Max at 175°C
- Low Noise 1.5ppm<sub>P-P</sub> (0.1Hz to 10Hz)
- No Thermal Shutdown
- Fully Specified from -40°C to 175°C
- Available in an 8-Lead MSOP Package

### APPLICATIONS

- Oil and Gas Exploration
- Down-Hole Drilling and Instrumentation
- Avionics
- Heavy Industrial
- High Temperature Automotive

### DESCRIPTION

The LT<sup>®</sup>6654BX is a 2.5V precision voltage reference that is rated for operation up to 175°C junction temperature. The LT6654BX operates from voltages up to 36V and is fully specified from -40°C to 175°C. A buffered output ensures both sourcing and sinking output current, with low output impedance and precise load regulation. These features, in combination, make the LT6654BX well positioned for high temperature environment applications.

Low thermal hysteresis ensures high accuracy and 1.5ppm<sub>P-P</sub> noise minimizes measurement uncertainty. Since the LT6654BX can also sink current, it can operate as a low power negative voltage reference with the same precision as a positive reference. The typical performance characteristics and the application information of the standard LT6654BH applies to the LT6654BX as well. See the LT6654 data sheet for more information.

The LT6654BX reference is offered in an 8-lead MSOP package.

All registered trademarks and trademarks are the property of their respective owners.

### TYPICAL APPLICATION

175°C Basic Connection

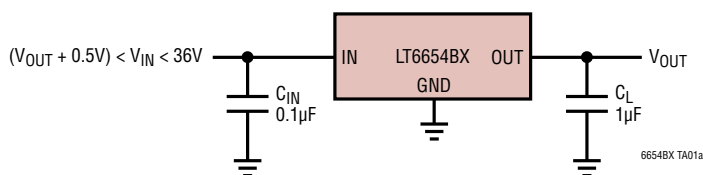

Output Voltage Temperature Drift

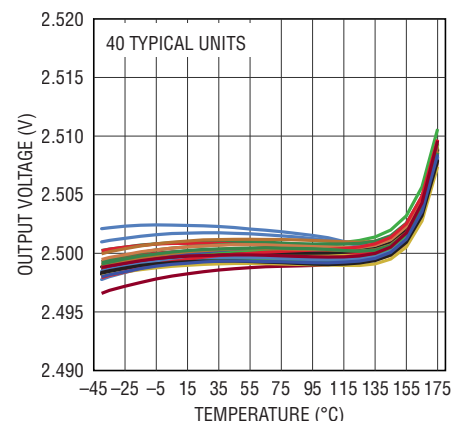

# LT6654BX

## ABSOLUTE MAXIMUM RATINGS

(Note 1)

Input Voltage $V_{IN}$ to GND .....	-0.3V to 38V
Output Voltage $V_{OUT}$ .....	-0.3V to $V_{IN} + 0.3V$
Output Short-Circuit Duration .....	Indefinite
Specified Junction Temperature Range	
X-Grade (Note 2) .....	-40°C to 175°C
Operating Junction Temperature Range	
(Note 3) .....	-60°C to 175°C
Storage Temperature Range (Note 4) .....	-65°C to 150°C

## PIN CONFIGURATION

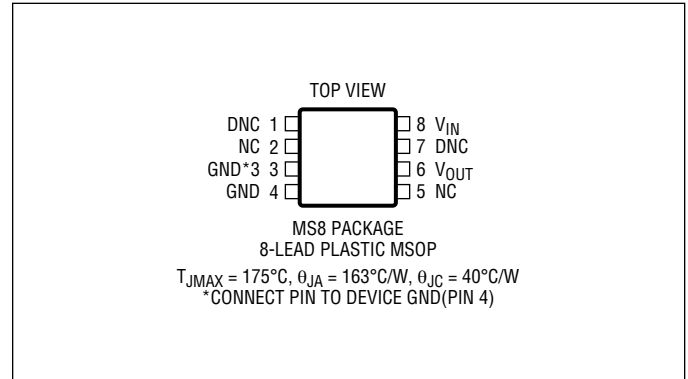

## ORDER INFORMATION

Lead Free Finish

TUBE	TAPE AND REEL	PART MARKING*	PACKAGE DESCRIPTION	SPECIFIED TEMPERATURE RANGE
LT6654BXMS8-2.5#PBF	LT6654BXMS8-2.5#TRPBF	LTHCD	8-Lead Plastic MSOP	-40°C to 175°C

Contact the factory for parts specified with wider operating temperature ranges. \*The temperature grade is identified by a label on the shipping container.

[Tape and reel specifications](#). Some packages are available in 500 unit reels through designated sales channels with #TRMPBF suffix.

**ELECTRICAL CHARACTERISTICS** The ● denotes the specifications which apply over the specified junction temperature range, otherwise specifications are at  $T_A = 25^\circ\text{C}$ ,  $C_{IN} = 0.1\mu\text{F}$ ,  $C_{OUT} = 1\mu\text{F}$ ,  $I_{OUT} = 0\text{A}$  and  $V_{IN} = V_{OUT} + 0.5\text{V}$ , unless otherwise noted.

PARAMETER	CONDITIONS	MIN	TYP	MAX	UNITS
Output Voltage Accuracy		-0.10 -0.43		0.10 1.00	% %
Output Voltage Temperature Coefficient (Note 6)			10	20	ppm/ $^\circ\text{C}$
Line Regulation (Note 7)	$V_{OUT} + 0.5\text{V} \leq V_{IN} \leq 36\text{V}$		1.2	5 30	ppm/V ppm/V
Load Regulation (Note 7)	$I_{OUT(SOURCE)} = 3\text{mA}$		3	8 50	ppm/mA ppm/mA
Load Regulation (Note 7)	$I_{OUT(SINK)} = 10\text{mA}$		17	35 80	ppm/mA ppm/mA
Dropout Voltage (Note 8)	$V_{IN} - V_{OUT}$ , $\Delta V_{OUT} = 0.1\%$ $I_{OUT} = 0\text{mA}$		55	100 120	mV mV
	$I_{OUT(SOURCE)} = 3\text{mA}$ $I_{OUT(SINK)} = 10\text{mA}$			400 50	mV mV
Supply Current	No Load		350	600	$\mu\text{A}$ $\mu\text{A}$
Output Short-Circuit Current (Note 9)	Short $V_{OUT}$ to GND Short $V_{OUT}$ to $V_{IN}$		40 30		mA mA
Output Voltage Noise (Note 10)	$0.1\text{Hz} \leq f \leq 10\text{Hz}$ $10\text{Hz} \leq f \leq 1\text{kHz}$		1.5 2.0		ppm <sub>P-P</sub> ppm <sub>RMS</sub>
Turn-On Time	0.1% Settling, $C_{LOAD} = 1\mu\text{F}$		150		$\mu\text{s}$
Long-Term Drift of Output Voltage (Note 11)			50		ppm/ $\sqrt{\text{kHr}}$
Hysteresis (Note 12)	$\Delta T = -40^\circ\text{C}$ to $125^\circ\text{C}$ $\Delta T = -40^\circ\text{C}$ to $175^\circ\text{C}$		26 30		ppm ppm

**Note 1:** Stresses beyond those listed under Absolute Maximum Ratings may cause permanent damage to the device. Exposure to any Absolute Maximum Rating condition for extended periods may affect device reliability and lifetime.

**Note 2:** Product lifetime decreases at very high temperature, predicted by the Arrhenius equation.

**Note 3:** By design, the LT6654BX is guaranteed functional over the operating junction temperature range of  $-60^\circ\text{C}$  to  $175^\circ\text{C}$ .

**Note 4:** If the parts are stored outside of the specified temperature range, the output may shift due to hysteresis.

**Note 5:** The stated temperature is typical for soldering of the leads during manual rework. For detailed IR reflow recommendations, refer to the Applications Information section.

**Note 6:** Temperature coefficient is measured by dividing the maximum change in output voltage by the specified temperature range of  $-40^\circ\text{C}$  to  $125^\circ\text{C}$ . For  $-40^\circ\text{C}$  to  $175^\circ\text{C}$  temperature range, the maximum output voltage accuracy is specified.

**Note 7:** Line and load regulations are measured on a pulse basis from no load to the specified load current. Output changes due to die temperature change must be taken into account separately.

**Note 8:** Excludes load regulation errors.

**Note 9:** LT6654BX does not have thermal protection.

**Note 10:** Peak-to-peak noise is measured with a 1-pole high pass filter at 0.1Hz and 2-pole low pass filter at 10Hz. The unit is enclosed in a still-air environment to eliminate thermocouple effects on the leads. The test time is 10 seconds. RMS noise is measured on a spectrum analyzer in a shielded environment where the intrinsic noise of the instrument is removed to determine the actual noise of the device.

**Note 11:** Long-term stability typically has a logarithmic characteristic and therefore, changes after 1000 hours tend to be much smaller than before that time. Total drift in the second thousand hours is normally less than one third that of the first thousand hours with a continuing trend toward reduced drift with time. Long-term stability will also be affected by differential stresses between the IC and the board material created during board assembly.

**Note 12:** Hysteresis in output voltage is created by package stress that differs depending on whether the IC was previously at a higher or lower temperature. Output voltage is always measured at  $25^\circ\text{C}$ , but the IC is cycled to the hot or cold temperature limit before successive measurements. Hysteresis measures the maximum output change for the averages of three hot or cold temperature cycles. For instruments that are stored at well controlled temperatures (within 20 or 30 degrees of operational temperature), it is usually not a dominant error source. Typical hysteresis is the worst-case of  $25^\circ\text{C}$  to cold to  $25^\circ\text{C}$  or  $25^\circ\text{C}$  to hot to  $25^\circ\text{C}$ , preconditioned by one thermal cycle.

## TYPICAL PERFORMANCE CHARACTERISTICS

The test conditions are  $T_A = 25^\circ\text{C}$ ,  $C_{IN} = 0.1\mu\text{F}$ ,  $C_{OUT} = 1\mu\text{F}$ ,  $I_{OUT} = 0\text{A}$  and  $V_{IN} = V_{OUT} + 0.5\text{V}$ , unless otherwise noted.

**2.5V Output Voltage Temperature Drift**

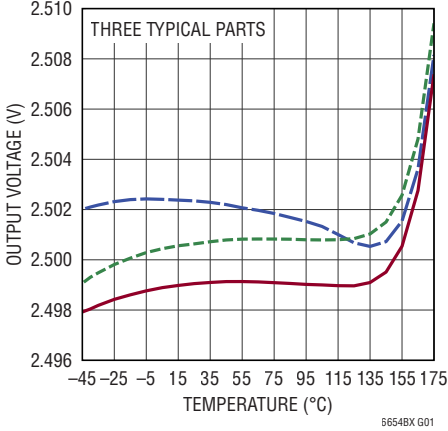

**2.5V Output Voltage Extended Temperature Drift**

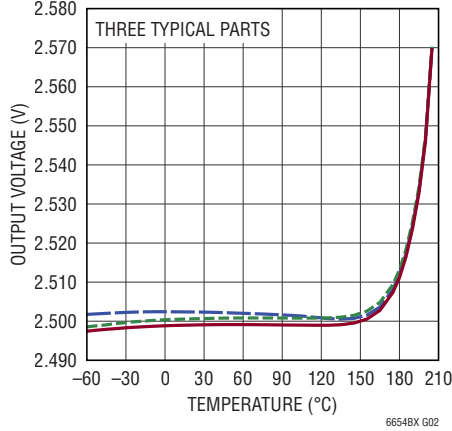

**2.5V Temperature Drift Distribution**

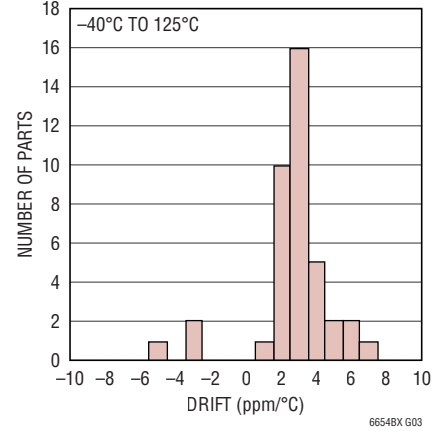

**2.5V Temperature Drift Distribution**

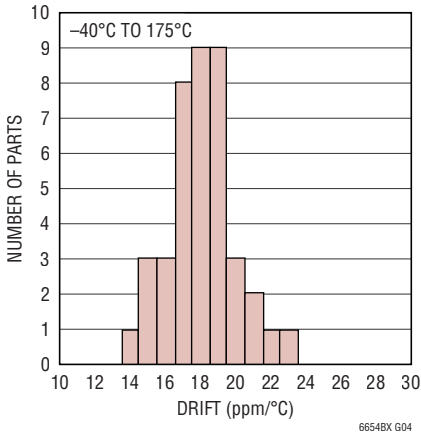

**2.5V  $V_{OUT}$  Distribution**

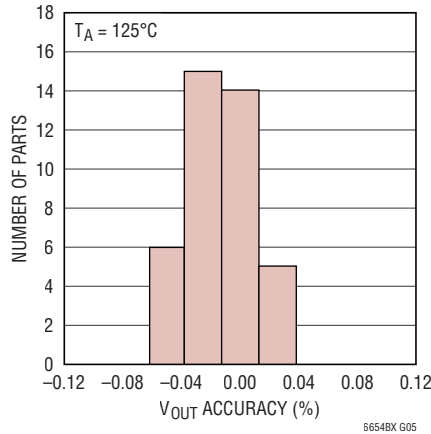

**2.5V  $V_{OUT}$  Distribution**

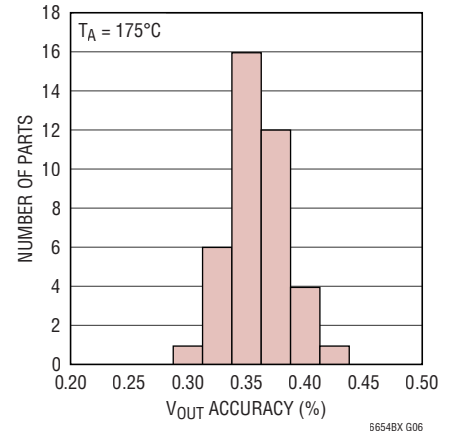

**2.5V Supply Current vs Supply Voltage**

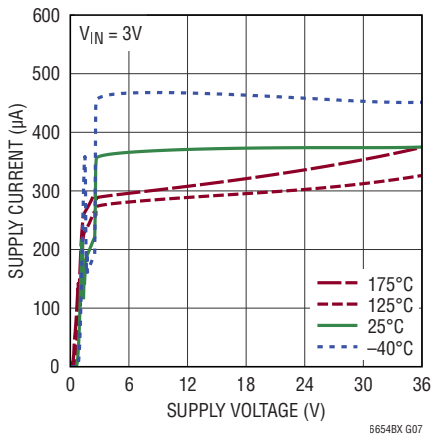

**2.5V Line Regulation vs Supply Voltage**

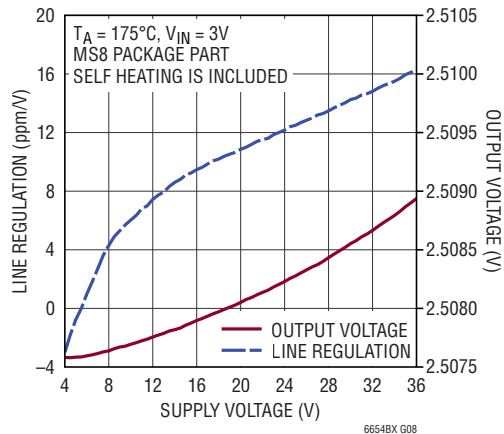

**TYPICAL PERFORMANCE CHARACTERISTICS** The test conditions are  $T_A = 25^\circ\text{C}$ ,  $C_{IN} = 0.1\mu\text{F}$ ,  $C_{OUT} = 1\mu\text{F}$ ,  $I_{OUT} = 0\text{A}$  and  $V_{IN} = V_{OUT} + 0.5\text{V}$ , unless otherwise noted.

**2.5V Line Regulation vs Temperature**

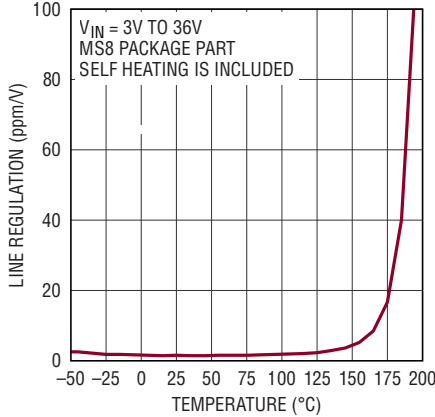

**2.5V Load Regulation (Sourcing) vs Temperature**

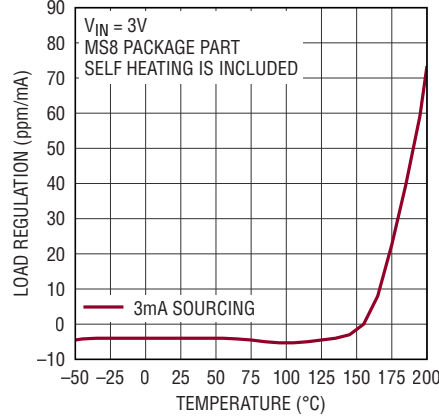

**2.5V Load Regulation (Sourcing) vs Time**

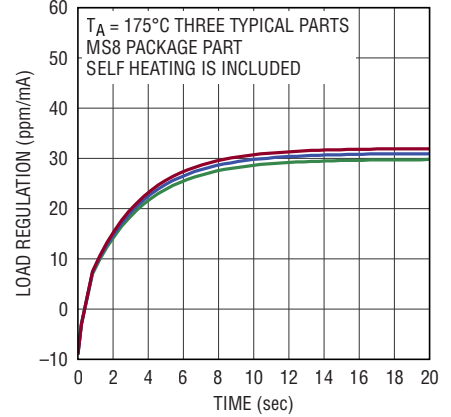

**2.5V Load Regulation (Sinking) vs Temperature**

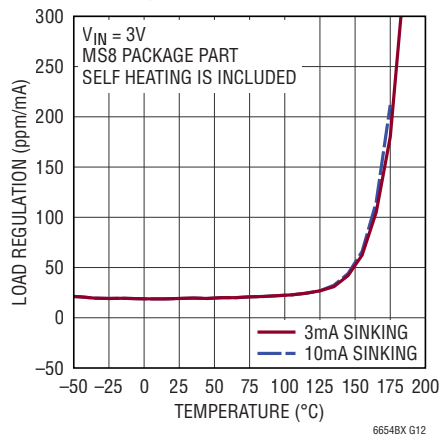

**2.5V Minimum  $V_{IN}$  to  $V_{OUT}$  Differential (Sourcing)**

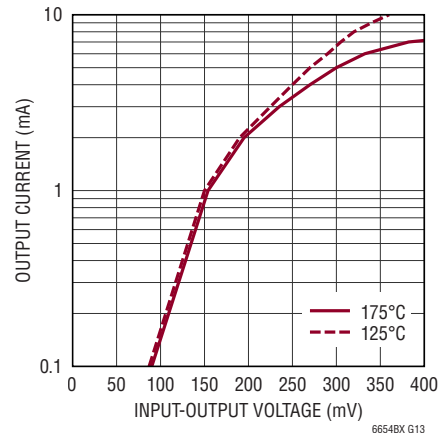

**2.5V Minimum  $V_{IN}$  to  $V_{OUT}$  Differential (Sinking)**

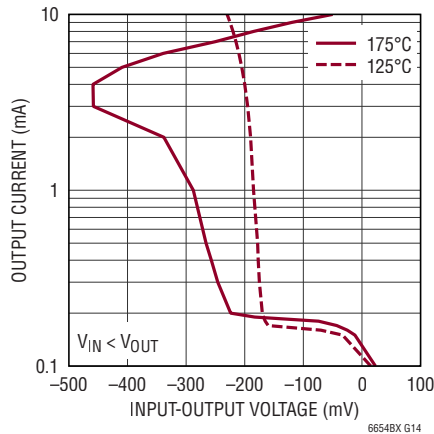

**2.5V Output Noise 0.1Hz to 10Hz**

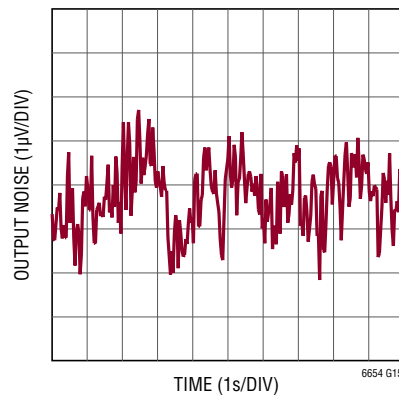

## TYPICAL PERFORMANCE CHARACTERISTICS

The test conditions are  $T_A = 25^\circ\text{C}$ ,  $C_{IN} = 0.1\mu\text{F}$ ,  $C_{OUT} = 1\mu\text{F}$ ,  $I_{OUT} = 0\text{A}$  and  $V_{IN} = V_{OUT} + 0.5\text{V}$ , unless otherwise noted.

**2.5V Output Voltage Noise Spectrum**

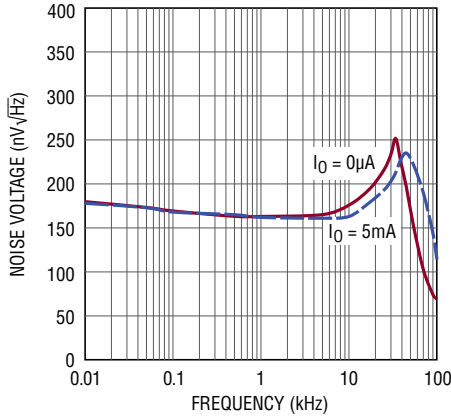

6654 G18

**2.5V Power Supply Rejection Ratio vs Frequency**

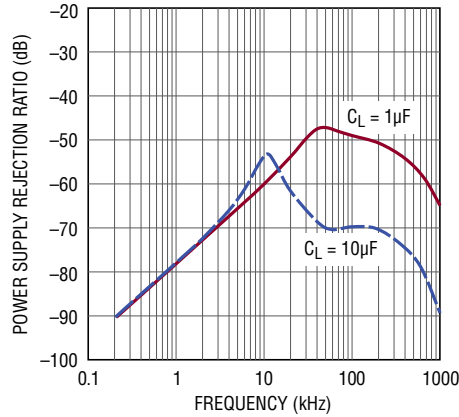

6654 G20

**2.5V Output Impedance vs Frequency**

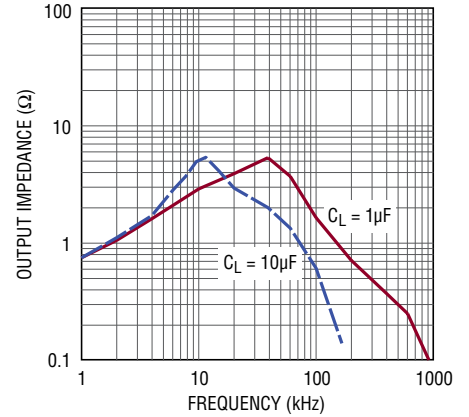

6654BX G18

## PIN FUNCTIONS

**DNC (Pins 1,7):** Do Not Connect. Keep leakage current from this pin to  $V_{IN}$  or GND to a minimum. To minimize leakage due to board contamination, encircle the pin with a metal ring connected to  $V_{OUT}$ .

**NC (Pin 2, 5):** Not internally connected. May be tied to  $V_{IN}$ ,  $V_{OUT}$ , GND or floated.

**GND (Pin 3):** Internal Function. This pin must be tied to GND near Pin 4.

**GND (Pin 4):** Primary Device Ground. Pin 3 and the load ground should be star-connected to Pin 4.

**$V_{OUT}$  (Pin 6):**  $V_{OUT}$  Pin. An output capacitor of  $1\mu\text{F}$  or greater is required for stable operation.

**$V_{IN}$  (Pin 8):** Power Supply. Bypass  $V_{IN}$  with a  $0.1\mu\text{F}$  or larger capacitor to GND.

## BLOCK DIAGRAM

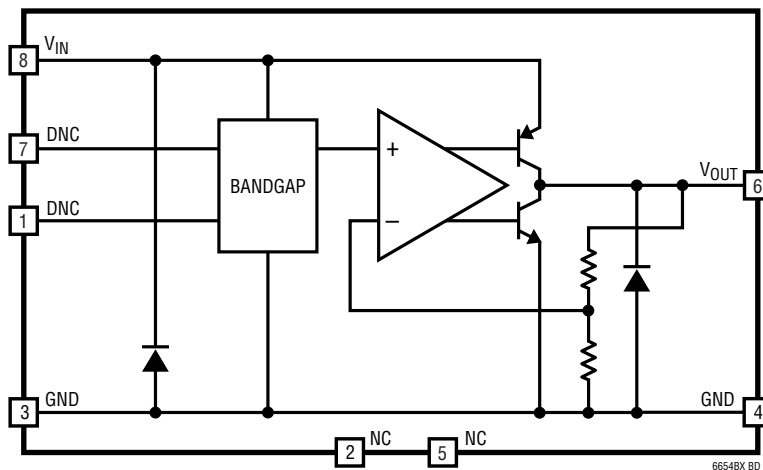

6654BX BD

Rev. 0

## APPLICATIONS INFORMATION

### Bypass and Load Capacitors

The LT6654BXMS8 operates between  $-40^{\circ}\text{C}$  to  $175^{\circ}\text{C}$ , and performs similarly to LT6654BHS6 within  $-40^{\circ}\text{C}$  to  $125^{\circ}\text{C}$  specified temperature range. The LT6654BX reference is offered in an MS8, 8-lead MSOP package.

The LT6654BX voltage reference should have an input bypass capacitor of  $0.1\mu\text{F}$  or larger. However, for light loading, the bypassing on other components nearby is sufficient. In high voltage applications,  $V_{\text{IN}} > 30\text{V}$ , a transient output short-circuit to ground can create an input voltage transient that could exceed the maximum input voltage rating. To prevent this worst-case condition, an RC input line filter of  $10\mu\text{s}$  (i.e.  $10\Omega$  and  $1\mu\text{F}$ ) is recommended.

This reference also requires an output capacitor for stability. The optimum output capacitance for most applications is  $1\mu\text{F}$ , although larger values work as well. This capacitor affects the turn-on and settling time for the output to reach its final value. Figures 1 and 2 show

the turn-on time for the LT6654BX, 2.5V output voltage with a  $0.1\mu\text{F}$  input bypass and  $1\mu\text{F}$  load capacitor at  $25^{\circ}\text{C}$  and  $175^{\circ}\text{C}$ , respectively. Figures 3 and 4 show the output response to a 0.5V transient on  $V_{\text{IN}}$  with the same capacitors, at  $25^{\circ}\text{C}$  and  $175^{\circ}\text{C}$ , respectively. The test circuit of Figure 5 is used to measure the stability with various load currents. With  $R_{\text{L}} = 1\text{k}$ , the 1V step produces a current step of 1mA. Figures 6 and 7 show the response to a  $\pm 0.5\text{mA}$  load at  $25^{\circ}\text{C}$  and  $175^{\circ}\text{C}$ , respectively. Figures 8 and 9 are the output response to a sourcing step at  $25^{\circ}\text{C}$  and  $175^{\circ}\text{C}$ , respectively, and Figures 10 and 11 are the output response of a sinking step at  $25^{\circ}\text{C}$  and  $175^{\circ}\text{C}$ , respectively.

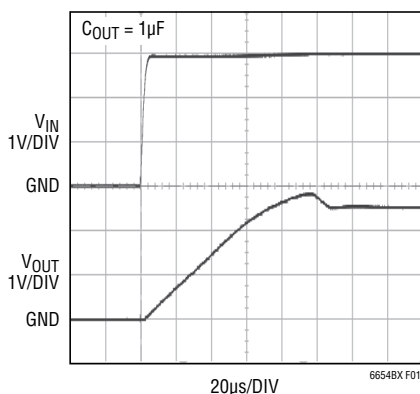

Figure 1.  $25^{\circ}\text{C}$  Turn-On Characteristics of LT6654BX-2.5

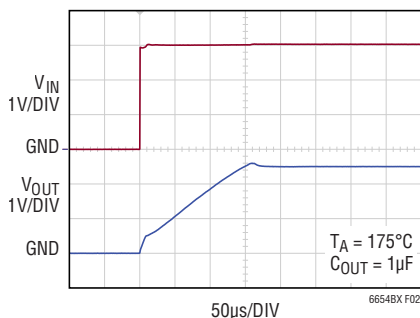

Figure 2.  $175^{\circ}\text{C}$  Turn-On Characteristics of LT6654BX-2.5

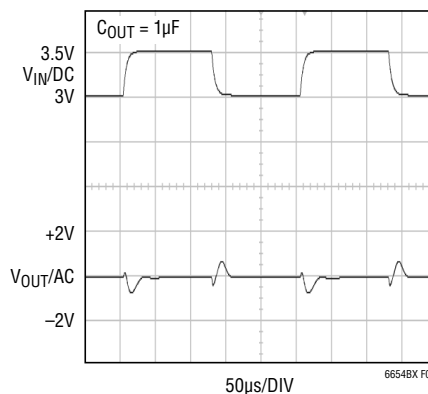

Figure 3.  $25^{\circ}\text{C}$  Output Response to 0.5V Ripple on  $V_{\text{IN}}$

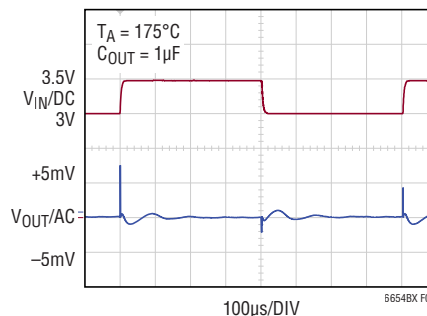
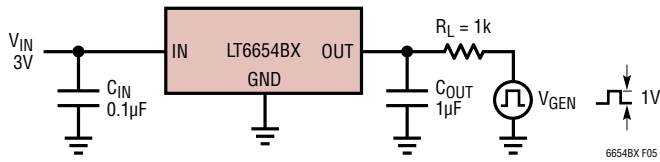
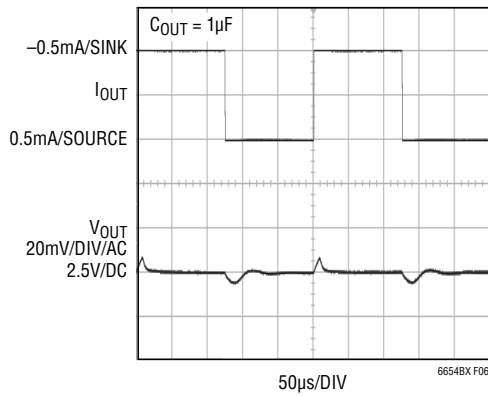

Figure 4.  $175^{\circ}\text{C}$  Output Response to 0.5V Ripple on  $V_{\text{IN}}$

## APPLICATIONS INFORMATION



**Figure 5. Load Current Response Time Test Circuit**



**Figure 6. 25°C LT6654BX-2.5 Sourcing and Sinking 0.5mA**

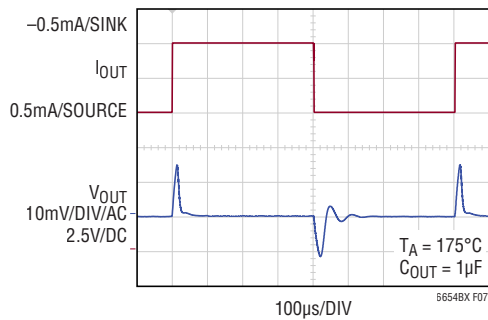

**Figure 7. 175°C LT6654BX-2.5 Sourcing and Sinking 0.5mA**

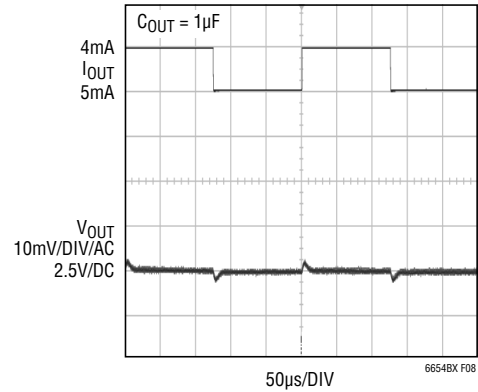

**Figure 8. 25°C LT6654BX-2.5 Sourcing 4mA to 5mA**

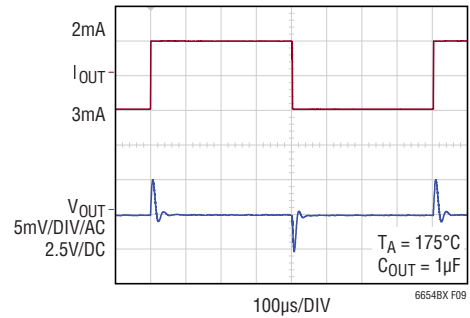

**Figure 9. 175°C LT6654BX-2.5 Sourcing 2mA to 3mA**

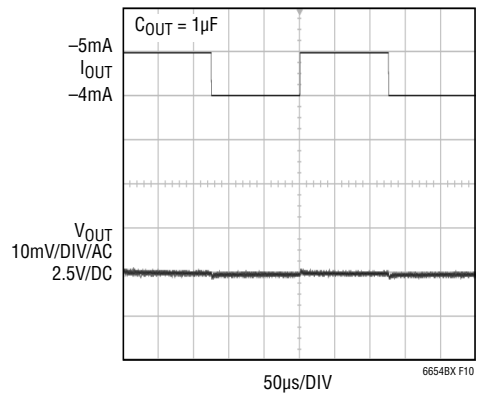

**Figure 10. 25°C LT6654BX-2.5 Sinking 4mA to 5mA**



## APPLICATIONS INFORMATION

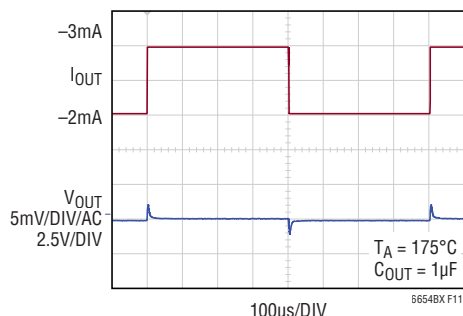

Figure 11. 175°C LT6654BX-2.5 Sinking 2mA to 3mA

### Positive or Negative Operation

In addition to the series connection, as shown on the front page of this data sheet, the LT6654BX can be operated as a negative voltage reference. The circuit in Figure 12 shows an LT6654BX configured for negative operation. In this configuration, a positive voltage is required at  $V_{IN}$  (Pin 8) to bias the LT6654BX internal circuitry. This voltage must be current limited with R1 to keep the output PNP transistor from turning on and driving the grounded output. C1 provides stability during load transients. This connection maintains the same accuracy and temperature coefficient of the positive connected LT6654BX.

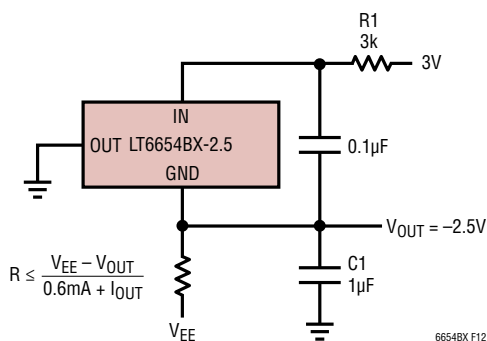

Figure 12. Using the LT6654BX-2.5 to Build a -2.5V Reference

### Long-Term Drift

Long-term drift cannot be extrapolated from accelerated high temperature testing. This erroneous technique gives drift numbers that are wildly optimistic. The only way long-term drift can be determined is to measure it over the time interval of interest. The LT6654BX drift data was taken on 40 parts that were soldered into PC boards similar to a real world application. The boards were then placed into a constant temperature oven with  $T_A = 35^\circ\text{C}$ , their outputs scanned regularly and measured with an 8.5 digit DVM. Long-term drift curves are shown in Figure 13. Their drift is much smaller after the first thousand hours.

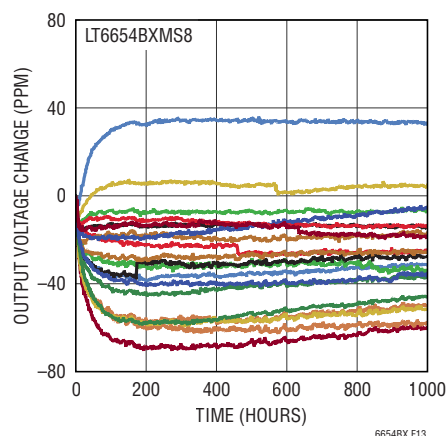

Figure 13. LT6654BX-2.5 Long Term Drift

### Power Dissipation

The allowed power dissipation in the LT6654BX is dependent on the ambient temperature,  $V_{IN}$ , the load current and the package. The LT6654BX package has a thermal resistance, or  $\theta_{JA}$ , of  $163^\circ\text{C}/\text{W}$ . A curve that illustrates allowed power dissipation versus temperature, for the 8-lead MSOP package, is shown in Figure 14. The typical power dissipation of the LT6654BX-2.5, as a function of input voltage and output current, is shown in Figure 15. Maximum allowed output regulated sourcing current is shown in Figure 16. It can be seen, for  $V_{IN} = 36\text{V}$  and

## APPLICATIONS INFORMATION

$T_A = 175^\circ\text{C}$ , the maximum sourcing regulated output current is at least 2mA. At  $25^\circ\text{C}$ , when operated within its specified limits of  $V_{IN} = 36\text{V}$  and sourcing 10mA, the LT6654BX-2.5 consumes about 356mW. Care must be taken when designing the circuit so that the maximum junction temperature is not exceeded. For best performance, junction temperature should be kept below  $175^\circ\text{C}$ . LT6654BX has no thermal protection. This allows the part to operate at very high temperatures. Nevertheless the maximum power dissipation should not be exceeded in any conditions. Changes in performance may occur as a result of operation at high temperature.

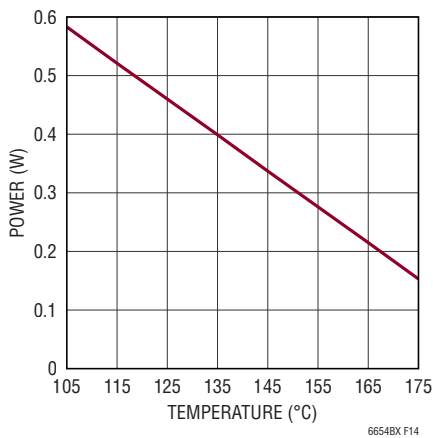

Figure 14. Maximum Allowed Power Dissipation for the LT6654BX

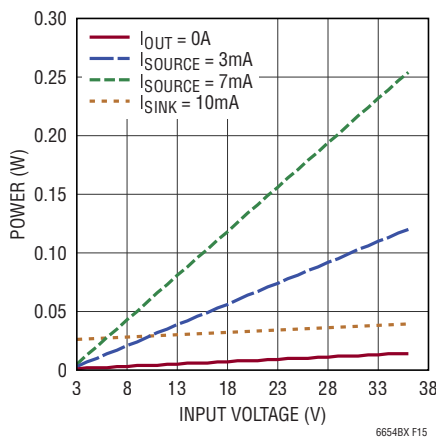

Figure 15. Typical Power Dissipation of the LT6654BX

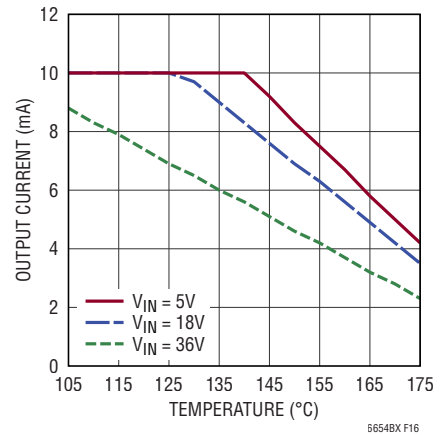

Figure 16. Maximum Allowed Output Regulated Current, Sourcing

### Hysteresis

The hysteresis data is shown in Figure 17 and 18. Figure 17 shows statistical hysteresis data according to the Note 12 of the EC table, while Figure 18 shows typical continuous hysteresis for three parts from  $25^\circ\text{C}$  to  $175^\circ\text{C}$  to  $25^\circ\text{C}$ . The LT6654BX is capable of dissipating relatively high power. For example, with a 36V input voltage and 10mA source current applied to the LT6654BX-2.5, the power dissipation is  $P_D = 348\text{mW}$ , which increases the die temperature by  $105^\circ\text{C}$ . This could raise the junction temperature above  $175^\circ\text{C}$  and may cause the output to shift due to thermal hysteresis.

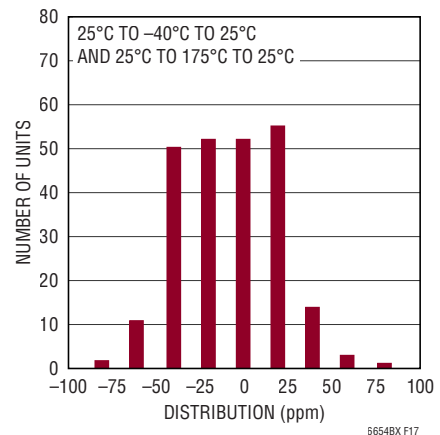

Figure 17. LT6654BX MS8 Thermal Hysteresis,  $-40^\circ\text{C}$  and  $175^\circ\text{C}$

## APPLICATIONS INFORMATION

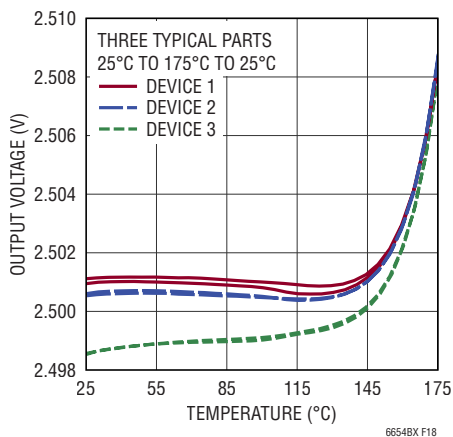

Figure 18. LT6654BX MS8 Thermal Hysteresis, 25°C to 175°C

### PC Board Layout

The mechanical stress of soldering a surface mount voltage reference to a PC board can cause the output voltage to shift and temperature coefficient to change. These two changes are not correlated. For example, the voltage may shift but the temperature coefficient may not. To reduce the effects of stress-related shifts, mount the reference near the short edge of the PC board or in a corner. In addition, slots can be cut into the board on two sides of the device. The capacitors should be mounted close to the LT6654BX. The GND and  $V_{OUT}$  traces should be as short as possible to minimize  $I \cdot R$  drops, since high trace resistance directly impacts load regulation.

### IR Reflow Shift

The different expansion and contraction rates of the materials that make up the LT6654BX package may cause the output voltage to shift after undergoing IR reflow. Lead free solder reflow profiles reach over 250°C, considerably more than with lead based solder. A typical lead free IR reflow profile is shown in Figure 19. Similar profiles are found using a convection reflow oven. LT6654BX devices, run up to three times through this reflow process, show that the standard deviation of the output voltage increases

with a slight negative mean shift of 0.004% as shown in Figure 20. While there can be up to 0.03% of output voltage shift, the overall drift of the LT6654 after IR reflow does not vary significantly.

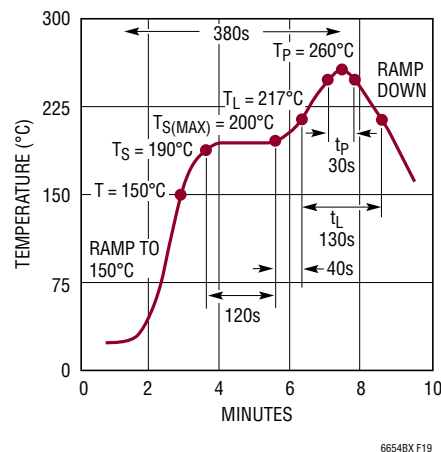

Figure 19. Lead Free Reflow Profile

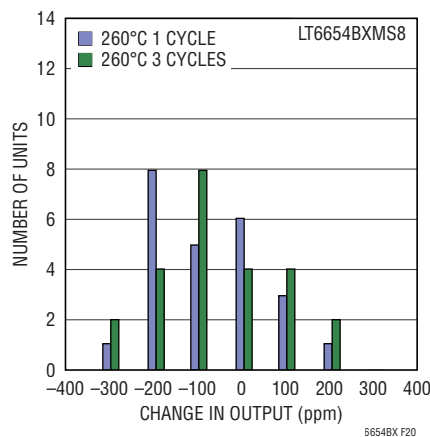

Figure 20. Output Voltage Shift Due to IR Reflow

### Humidity Sensitivity

Plastic mould compounds absorb water. With changes in relative humidity, plastic packaging materials change the amount of pressure they apply to the die inside, which can cause slight changes in the output of a voltage reference, usually on the order of 100ppm.

## TYPICAL APPLICATIONS

### Positive Voltage Reference

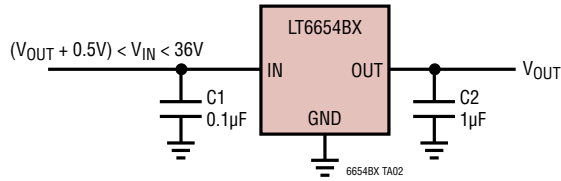

### Negative Voltage Reference

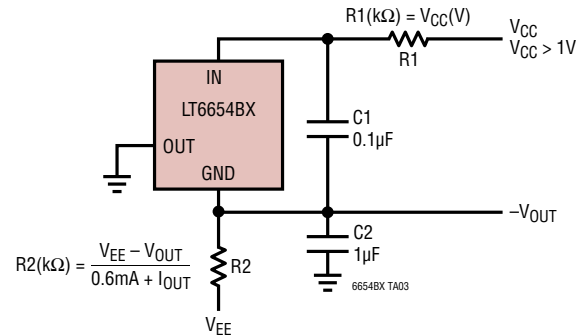

### Low Current Extended Supply Range Reference

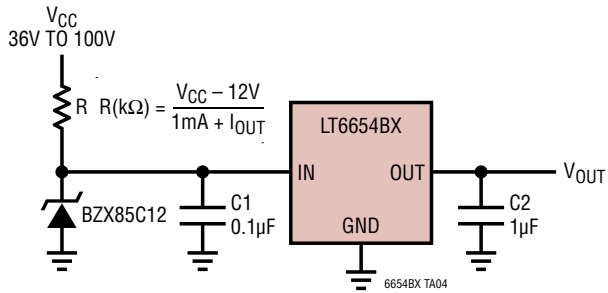

### High Current Extended Supply Range Reference

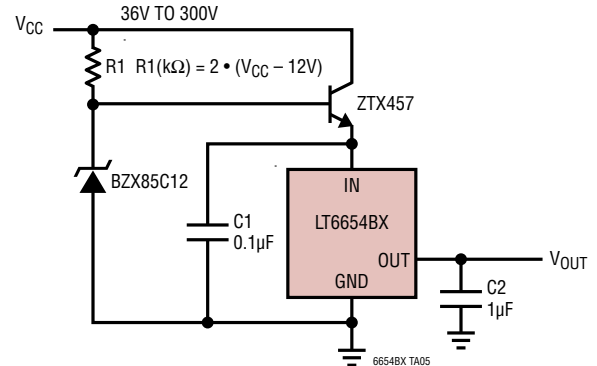

**PACKAGE DESCRIPTION**

**MS8 Package**  
**8-Lead Plastic MSOP**  
 (Reference LTC DWG # 05-08-1660 Rev G)

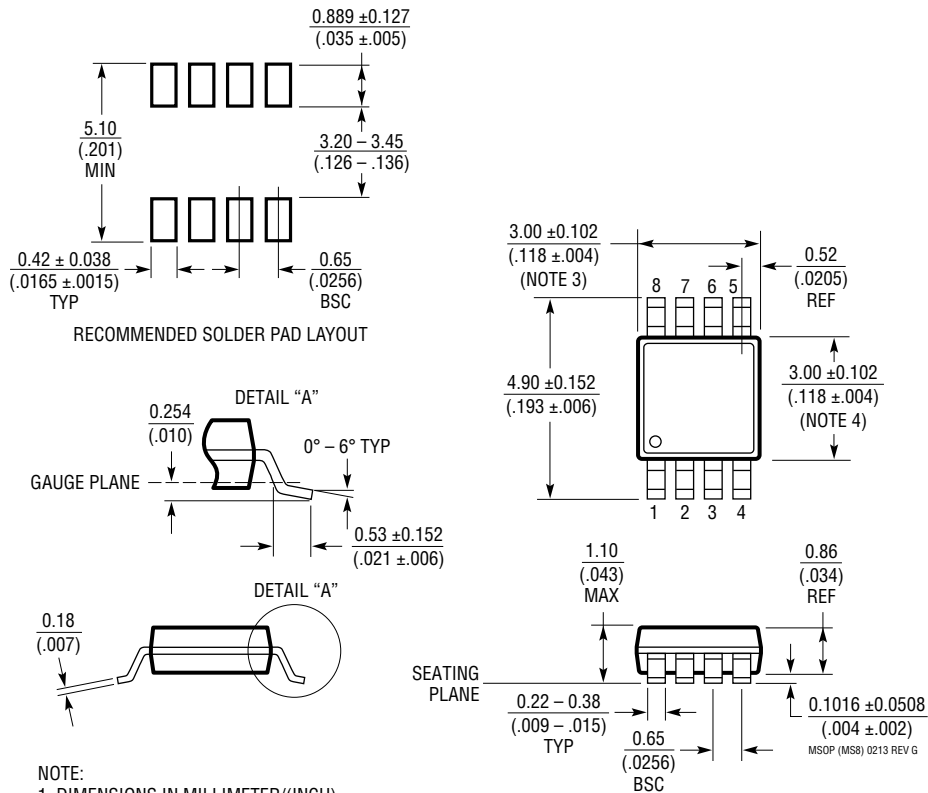

- NOTE:
1. DIMENSIONS IN MILLIMETER/(INCH)
  2. DRAWING NOT TO SCALE
  3. DIMENSION DOES NOT INCLUDE MOLD FLASH, PROTRUSIONS OR GATE BURRS.  
 MOLD FLASH, PROTRUSIONS OR GATE BURRS SHALL NOT EXCEED 0.152mm (.006") PER SIDE
  4. DIMENSION DOES NOT INCLUDE INTERLEAD FLASH OR PROTRUSIONS.  
 INTERLEAD FLASH OR PROTRUSIONS SHALL NOT EXCEED 0.152mm (.006") PER SIDE
  5. LEAD COPLANARITY (BOTTOM OF LEADS AFTER FORMING) SHALL BE 0.102mm (.004") MAX

## TYPICAL APPLICATION

### 175°C Boosted Output Current

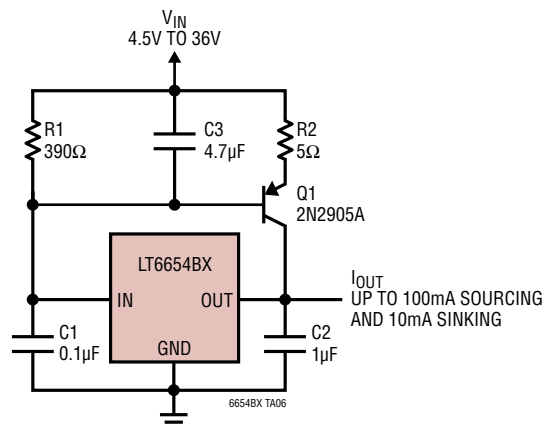

## RELATED PARTS

PART NUMBER	DESCRIPTION	COMMENTS
<a href="#">LT6654</a>	Precision, High Voltage, High Output Drive Voltage Reference Family	0.05% Max, 36V Supply, Sink/Source $\pm 10\text{mA}$ , 10ppm/ $^{\circ}\text{C}$ Max Drift, $-40^{\circ}\text{C}$ to $125^{\circ}\text{C}$ Operation
<a href="#">ADR225</a>	High Temperature, Micro-Power 2.5V Reference	$175^{\circ}\text{C}$ and $210^{\circ}\text{C}$ Operation, 10mA Sourcing, 30 $\mu\text{A}$ Supply, 10ppm/ $^{\circ}\text{C}$ for $-40^{\circ}\text{C}$ to $175^{\circ}\text{C}$
<a href="#">AD7981</a>	High Temperature, 16-bit, 600kSPS pulSAR <sup>®</sup> ADC	SNR 91dB, 2.5V Supply, 2.25mW at 600kSPS, $-55^{\circ}\text{C}$ to $175^{\circ}\text{C}$ (10-Lead MSOP)
<a href="#">LT6107</a>	High Temperature Current Sense Amplifier	$V_{\text{in}}$ : 2.7V to 36V, 250 $\mu\text{V}$ Offset, $-55^{\circ}\text{C}$ to $150^{\circ}\text{C}$
<a href="#">LT1007X</a>	High Temperature, High Voltage Op Amp	$200^{\circ}\text{C}$ Operation, $\pm 15\text{V}$ Supply, Low Noise
<a href="#">LT1210X</a>	High Temperature Current Feedback Amplifier	1.0A, 900V/ $\mu\text{s}$ Slew Rate, 35MHz, $-40^{\circ}\text{C}$ to $175^{\circ}\text{C}$
<a href="#">LT6203X</a>	High Temperature Dual Op Amp	100MHz, 1.9nV/ $\sqrt{\text{Hz}}$ Noise, Rail-to-Rail Input and Output, $-40^{\circ}\text{C}$ to $175^{\circ}\text{C}$
<a href="#">LTC<sup>®</sup>6652</a>	Precision Low Drift Low Noise Buffered Reference	0.5% Max, 5ppm/ $^{\circ}\text{C}$ Max, 2.1ppm <sub>P-P</sub> Noise (0.1Hz to 10Hz) 100% Tested at $-40^{\circ}\text{C}$ , $25^{\circ}\text{C}$ and $125^{\circ}\text{C}$
<a href="#">LTC6655</a>	Precision Low Noise Reference	2ppm/ $^{\circ}\text{C}$ Max, 650nV <sub>P-P</sub> Noise (0.1Hz to 10Hz) 100% Tested at $-40^{\circ}\text{C}$ , $25^{\circ}\text{C}$ and $125^{\circ}\text{C}$
<a href="#">LT6657</a>	Low Temp Co, Low Noise, High Voltage Reference	1.5ppm/ $^{\circ}\text{C}$ Max, 40V Supply, 0.8ppm <sub>RMS</sub> Noise, $-40^{\circ}\text{C}$ to $125^{\circ}\text{C}$
<a href="#">LT6658</a>	Precision, High Current, Low Noise Reference	200mA Output Current, Dual Output, 36V Supply, $-40^{\circ}\text{C}$ to $125^{\circ}\text{C}$