

SP1044 Series 30pF 30kV Unidirectional Discrete TVS



**OBSOLETE** DATE: 6/10/2020 PCN/ECN# ESU270-51  
REPLACED BY: SP1020-01WTG



**Description**

Avalanche breakdown diodes fabricated in a proprietary silicon avalanche technology protect each I/O pin to provide a high level of protection for electronic equipment that may experience destructive electrostatic discharges (ESD). These robust diodes can safely absorb repetitive ESD strikes at  $\pm 30\text{kV}$  (contact discharge, IEC 61000-4-2) without performance degradation. Additionally, each diode can safely dissipate 3A of 8/20 $\mu\text{s}$  surge current (IEC 61000-4-5 2nd edition) with very low clamping voltages

**Pinout**

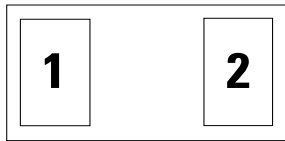

Note: Drawing not to scale

**Features**

- ESD, IEC 61000-4-2,  $\pm 30\text{kV}$  contact,  $\pm 30\text{kV}$  air
- EFT, IEC 61000-4-4, 40A (5/50ns)
- Lightning, IEC 61000-4-5, 2nd edition, 3A ( $t_p=8/20\mu\text{s}$ )
- Low capacitance of 30pF (@  $V_R=0\text{V}$ )
- Low leakage current of 0.1 $\mu\text{A}$  at 5V
- Industries smallest ESD footprint available (01005)
- Halogen free, Lead free and RoHS compliant

**Functional Block Diagram**

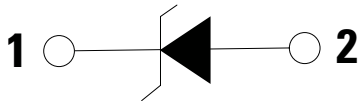

**Applications**

- Mobile Phones
- Smart Phones
- Camcorders
- Portable Medical
- Digital Cameras
- Wearable Technology
- Portable Navigation Components
- Tablets
- Point of Sale Terminals

Life Support Note:

**Not Intended for Use in Life Support or Life Saving Applications**

The products shown herein are not designed for use in life sustaining or life saving applications unless otherwise expressly indicated.

### Absolute Maximum Ratings

Symbol	Parameter	Value	Units
$I_{PP}$	Peak Current ( $t_p=8/20\mu s$ )	3.0 <sup>1</sup>	A
$T_{OP}$	Operating Temperature	-40 to 125	°C
$T_{STOR}$	Storage Temperature	-55 to 150	°C

**1. CAUTION:** Stresses above those listed in "Absolute Maximum Ratings" may cause permanent damage to the component. This is a stress only rating and operation of the component at these or any other conditions above those indicated in the operational sections of this specification is not implied.

### Thermal Information

Parameter	Rating	Units
Storage Temperature Range	-55 to 150	°C
Maximum Junction Temperature	150	°C
Maximum Lead Temperature (Soldering 20-40s)	260	°C

### Electrical Characteristics ( $T_{OP}=25^{\circ}C$ )

Parameter	Symbol	Test Conditions	Min	Typ	Max	Units
Reverse Standoff Voltage	$V_{RWM}$	-	-	-	6.0	V
Leakage Current	$I_{LEAK}$	$V_R=5V$ with 1 pin at GND	-	0.1	0.5	$\mu A$
Clamp Voltage <sup>1</sup>	$V_C$	$I_{pp}=1A, t_p=8/20\mu s$ , Fwd	-	8.3	-	V
		$I_{pp}=2A, t_p=8/20\mu s$ , Fwd	-	9.3	-	V
Dynamic Resistance <sup>2</sup>	$R_{DYN}$	TLP, $t_p=100ns$ , I/O to GND	-	0.18	-	$\Omega$
ESD Withstand Voltage <sup>1</sup>	$V_{ESD}$	IEC 61000-4-2 (Contact Discharge)	$\pm 30$	-	-	kV
		IEC 61000-4-2 (Air Discharge)	$\pm 30$	-	-	kV
Diode Capacitance <sup>1</sup>	$C_D$	Reverse Bias=0V	-	30	35	pF

**Notes:**

- Parameter is guaranteed by design and/or component characterization.
- Transmission Line Pulse (TLP) with 100ns width, 2ns rise time, and average window  $t_1=70ns$  to  $t_2=90ns$

### 8/20 $\mu s$ Pulse Waveform

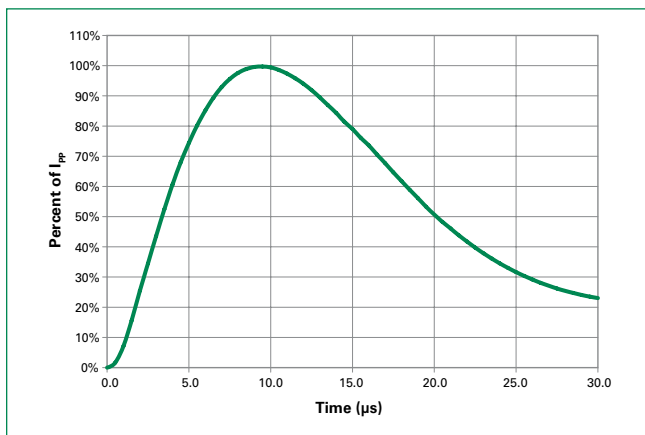

### Capacitance vs. Reverse Bias

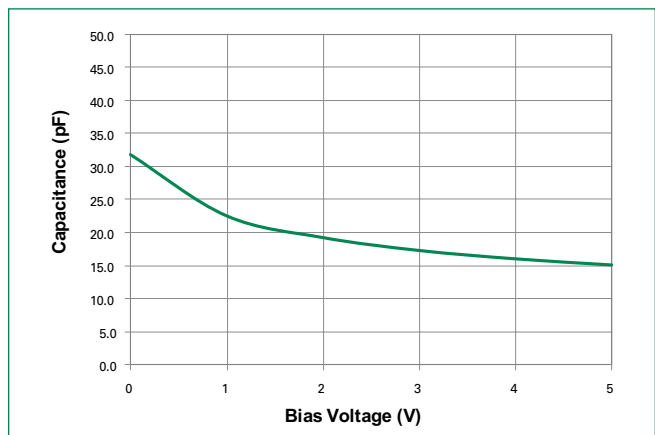

**Postive Transmission Line Pulsing(TLP) Plot**

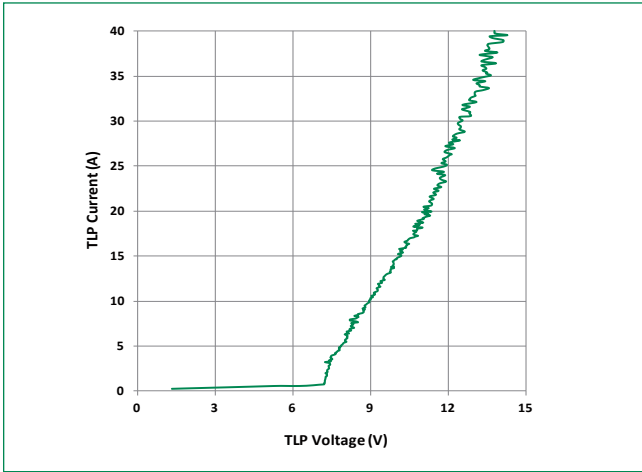

**Negative Transmission Line Pulsing(TLP) Plot**

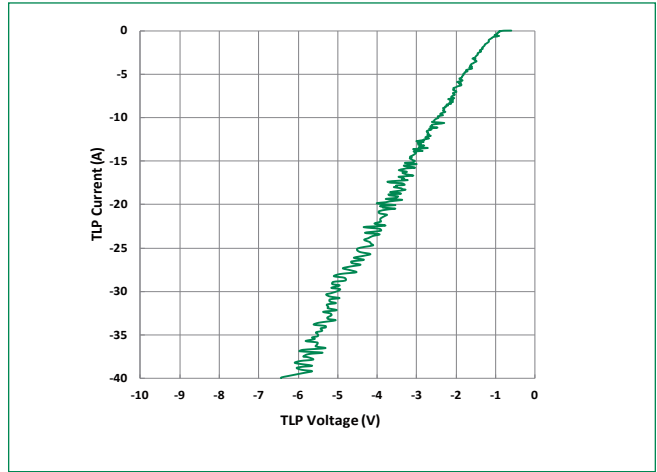

**Clamping Voltage vs I<sub>pp</sub>**

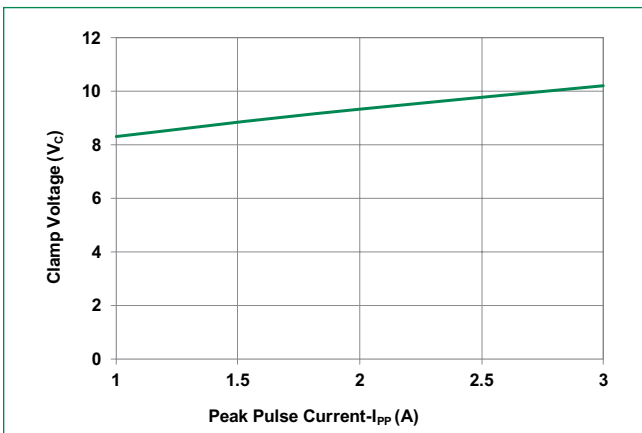

**Soldering Parameters**

<b>Reflow Condition</b>		Pb – Free assembly
<b>Pre Heat</b>	- Temperature Min ( $T_{s(min)}$ )	150°C
	- Temperature Max ( $T_{s(max)}$ )	200°C
	- Time (min to max) ( $t_s$ )	60 – 180 secs
<b>Average ramp up rate (Liquidus) Temp (<math>T_L</math>) to peak</b>		3°C/second max
<b><math>T_{S(max)}</math> to <math>T_L</math> - Ramp-up Rate</b>		3°C/second max
<b>Reflow</b>	- Temperature ( $T_L$ ) (Liquidus)	217°C
	- Temperature ( $t_L$ )	60 – 150 seconds
<b>Peak Temperature (<math>T_p</math>)</b>		260 <sup>+0/-5</sup> °C
<b>Time within 5°C of actual peak Temperature (<math>t_p</math>)</b>		20 – 40 seconds
<b>Ramp-down Rate</b>		6°C/second max
<b>Time 25°C to peak Temperature (<math>T_p</math>)</b>		8 minutes Max.
<b>Do not exceed</b>		260°C

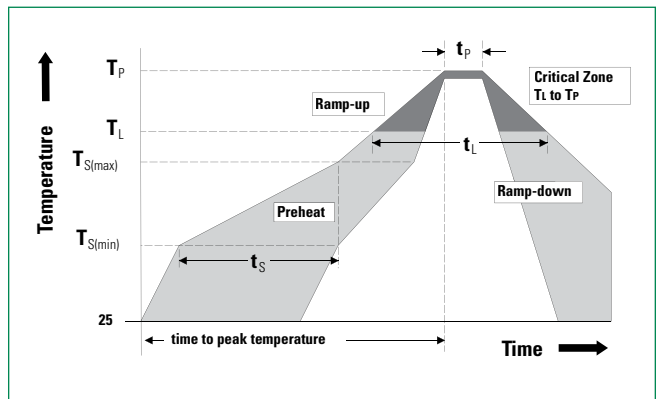

**Part Marking System**

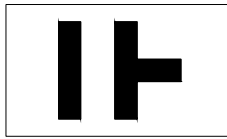

**Part Numbering System**

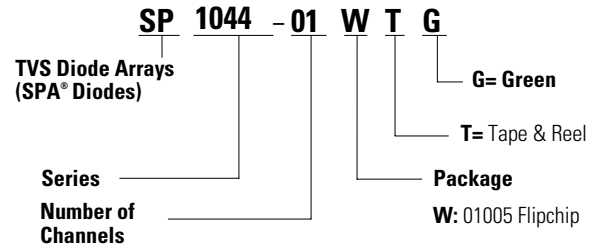

**Ordering Information**

Part Number	Package	Min. Order Qty.
SP1044-01WTG	01005 Flipchip	15000

**Package Dimensions — 01005 Flipchip**

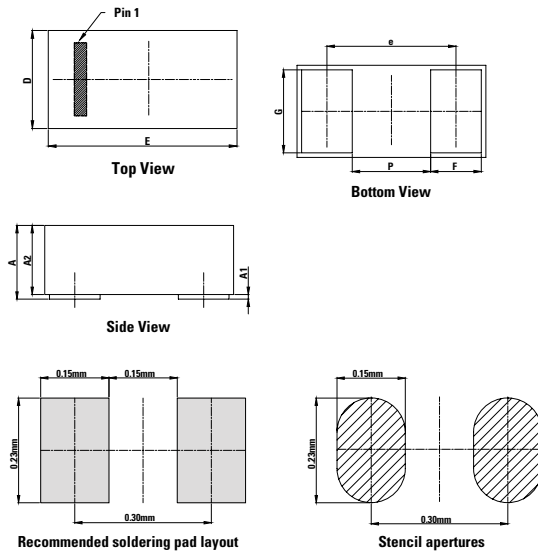

Symbol	01005 Flipchip					
	Millimeters			Inches		
	Min	Typ	Max	Min	Typ	Max
A	0.168	0.181	0.194	0.007	0.007	0.008
A1	0.008	0.011	0.014	0.000	0.000	0.001
A2	0.160	0.170	0.180	0.006	0.007	0.007
e	0.280 BSC			0.011 BSC		
D	0.200	0.230	0.260	0.008	0.009	0.010
E	0.400	0.430	0.460	0.016	0.017	0.018
F	0.110	0.130	0.150	0.004	0.005	0.006
G	0.180	0.200	0.220	0.007	0.008	0.009
P	0.130	0.150	0.170	0.005	0.006	0.007

**Embossed Carrier Tape & Reel Specification — 01005 Flipchip**

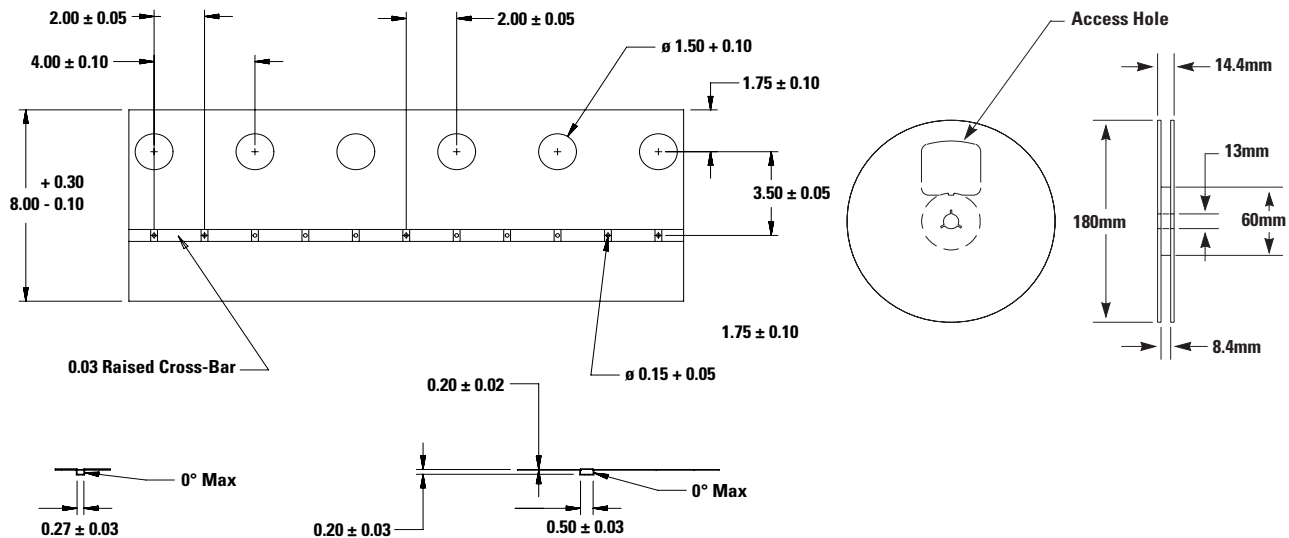

**Disclaimer Notice** - Information furnished is believed to be accurate and reliable. However, users should independently evaluate the suitability of and test each product selected for their own applications. Littelfuse products are not designed for, and may not be used in, all applications. Read complete Disclaimer Notice at: [www.littelfuse.com/disclaimer-electronics](http://www.littelfuse.com/disclaimer-electronics)