

Pb-free  
HEAT

**STANLEY**

# SW1148C

1608 (h=0.35 mm) Type White LED

## Features

Package	1608 (h=0.35 mm) Type, Pale yellow resin
Product features	<ul style="list-style-type: none"><li>• Outer Dimension 1.6 x 0.8 x 0.35mm( L x W x H )</li><li>• Temperature range Storage Temperature : -40°C~100°C Operating Temperature : -40°C~ 85°C</li><li>• Lead-free soldering compatible</li><li>• RoHS compliant</li></ul>
Chromaticity coordinates	x = 0.27TYP., y = 0.26TYP. (Condition : I <sub>F</sub> =1mA)
Half Intensity Angle	$\theta_x = 140 \text{ deg.}, \theta_y = 162 \text{ deg.}$
Die materials	InGaN
Rank grouping parameter	Sorted by luminous intensity and chromaticity per rank taping
Assembly method	Auto pick & place machine (Auto Mounter)
Soldering methods	Reflow soldering and manual soldering
Taping and reel	4,000pcs per reel in a 8mm width tape. (Standard) Reel diameter: $\phi 180\text{mm}$
ESD	1kV (HBM)

## Recommended Applications

Cellular Phone only



**SW1148C**

1608 (h=0.35 mm) Type White LED

Color and Luminous Intensity

(Ta=25°C)

Part No.	Material	Emitted Color	Lens Color	Luminous Intensity		
				Iv (mcd)		
				MIN.	TYP.	I <sub>F</sub>
SW1148C	InGaN	White	Pale Yellow	10	25	1

## Absolute Maximum Ratings

(Ta=25°C)

Item	Symbol	Absolute Maximum Ratings	Unit
Power Dissipation	$P_d$	21	mW
Forward Current	$I_F$	6	mA
Pulse Forward Current ※1	$I_{FRM}$	12	mA
Derating (Ta=25°C or higher)	$\Delta I_F$	0.08	mA/°C
	$\Delta I_{FRM}$	0.16	mA/°C
Reverse Voltage	$V_R$	5	V
Operating Temperature	$T_{opr}$	-40~+85	°C
Storage Temperature	$T_{stg}$	-40~+100	°C

 ※1  $I_{FRM}$  Measurement condition : Pulse Width  $\leq 1$ ms., Duty  $\leq 1/20$ .

## Electro-Optical Characteristics

(Ta=25°C)

Item	Conditions	Symbol	Characteristics		Unit
			TYP.	MAX.	
Forward Voltage <sup>※1</sup>	I <sub>F</sub> =1mA	V <sub>F</sub>	TYP.	2.8	V
			MAX.	3.0	
Reverse Current	V <sub>R</sub> =5V	I <sub>R</sub>	MAX.	100	μA
Half Intensity Angle	I <sub>F</sub> =1mA	2θ 1/2	TYP.	140(θ x)	deg.
				162(θ y)	
Chromaticity Coordinates	I <sub>F</sub> =1mA	x	TYP.	0.27	-
		y	TYP.	0.26	-

※1 Forward Voltage Tolerance Range : ±0.1V

## Luminous Intensity Rank

(Ta=25°C)

Intensity Tolerance each Rank : +/-10%

Rank	I <sub>v</sub> (mcd)		Condition
	MIN.	MAX.	
A	10	16	I <sub>f</sub> =1mA
B	16	25	
C	25	40	
D	40	64	
E	64	-	

※ Please contact our sales staff concerning rank designation.

# Sorting Chart for Chromaticity Coordinates

(Ta=25°C)

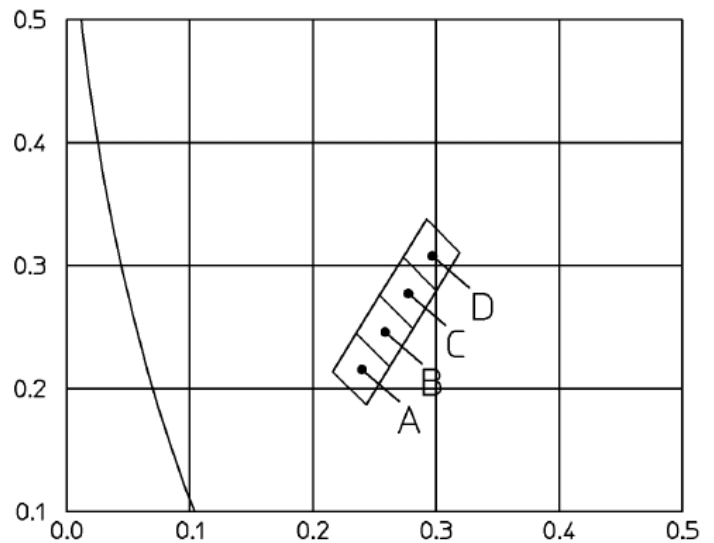
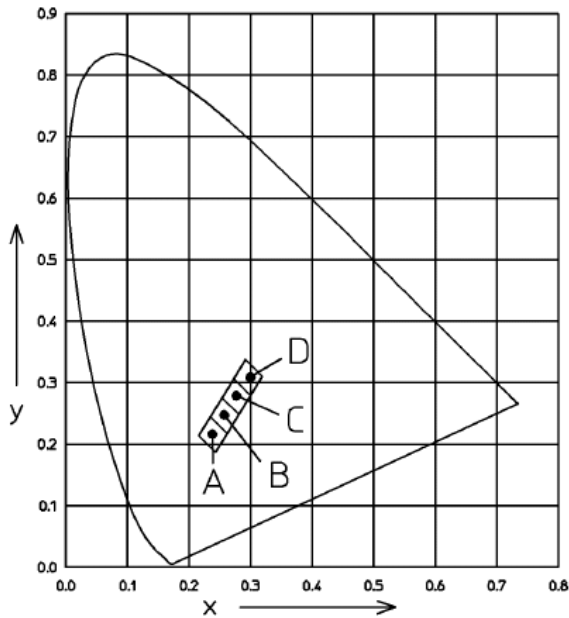

Chromaticity Coordinates Tolerance Each Rank : +/-0.02

Rank	LEFT DOWN point		LEFT UP point		RIGHT UP point		RIGHT UP point	
	x	y	x	y	x	y	x	y
A	0.243	0.187	0.216	0.214	0.235	0.245	0.262	0.218
B	0.262	0.218	0.235	0.245	0.254	0.276	0.281	0.249
C	0.281	0.249	0.254	0.276	0.273	0.307	0.300	0.280
D	0.300	0.280	0.273	0.307	0.292	0.338	0.319	0.311

※ Please contact our sales staff concerning rank designation.

## Technical Data

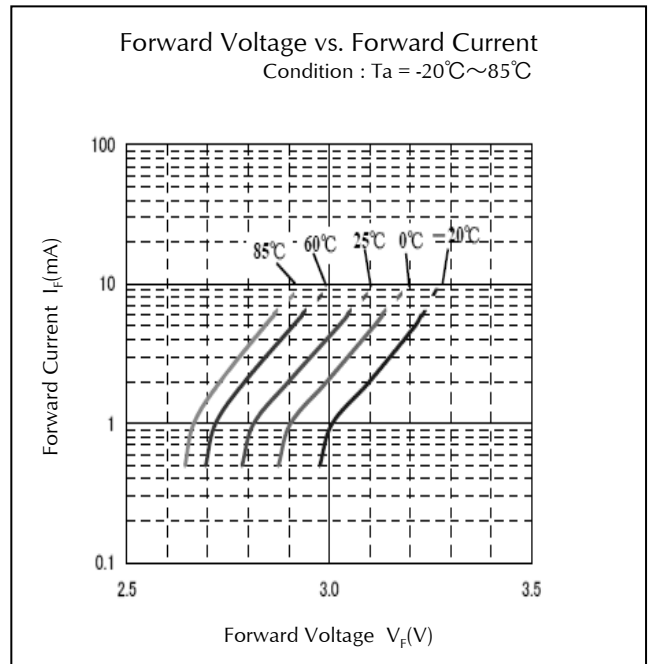
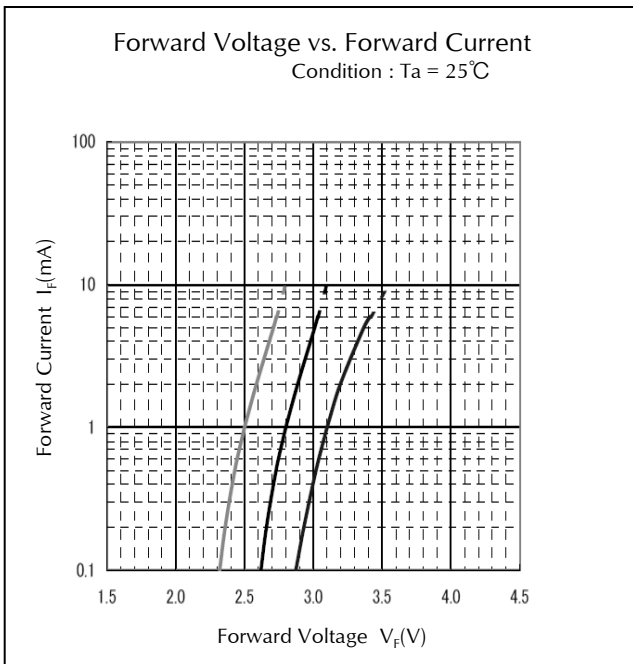
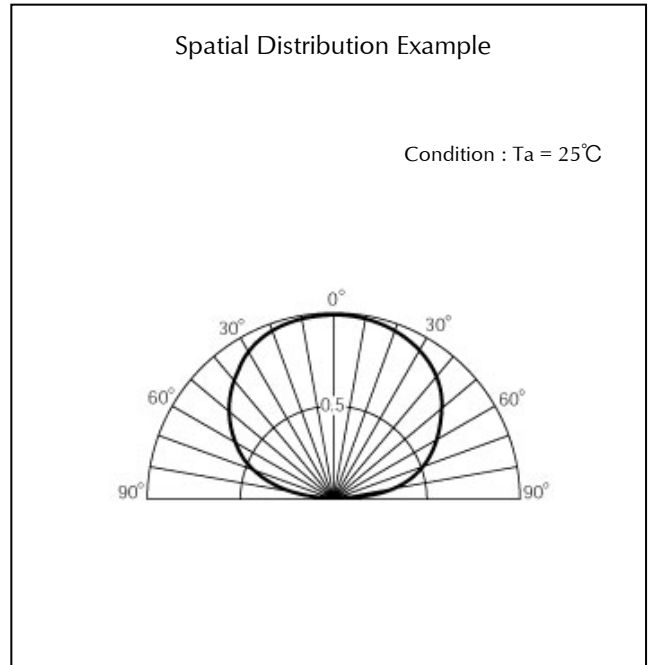
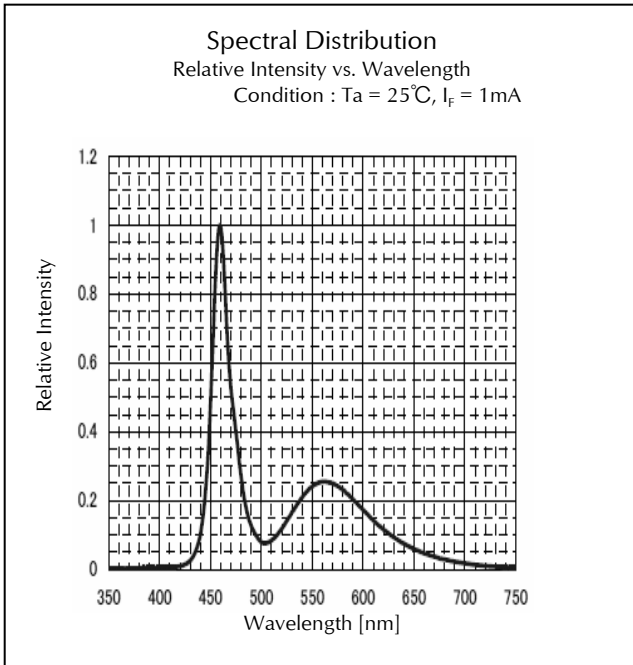

## Technical Data

Forward Current vs. Relative Intensity

Condition :  $T_a = 25^\circ\text{C}$

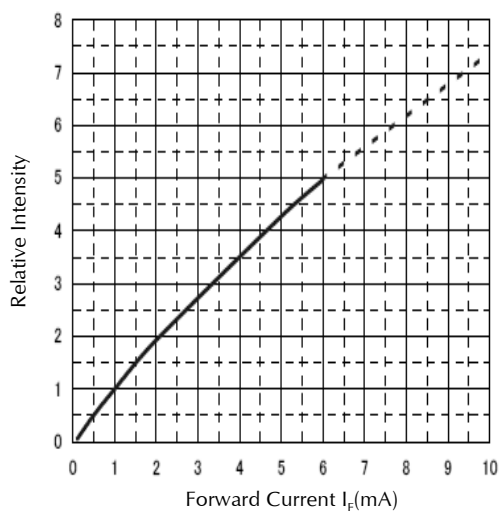

Derating

Ambient Temperature vs. Maximum Forward Current  
 Repetition Frequency :  $f \geq 10\text{Hz}$

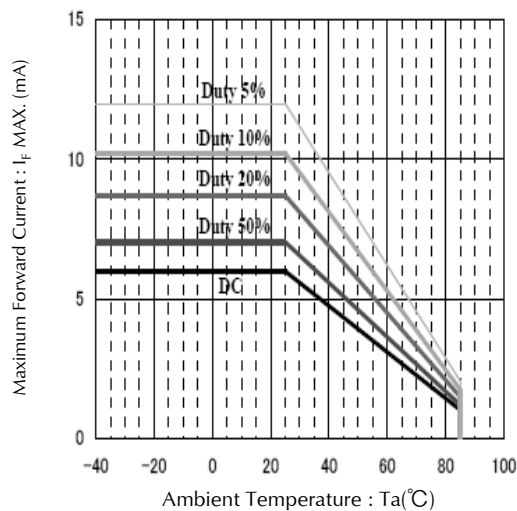

Ambient Temperature vs. Relative Intensity

Condition :  $I_f = 1\text{mA}$

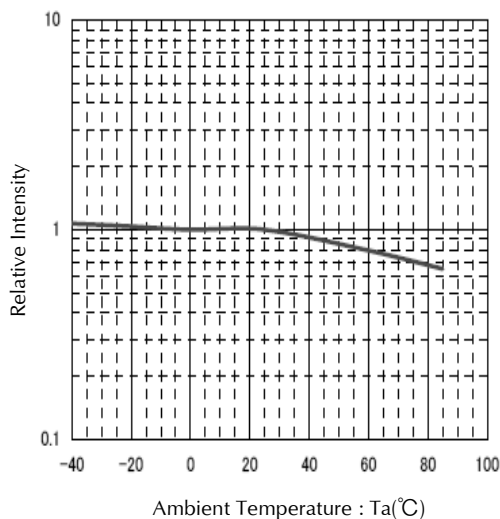

Ambient Temperature vs. Forward Voltage

Condition :  $I_f = 0.5 \sim 10\text{mA}$

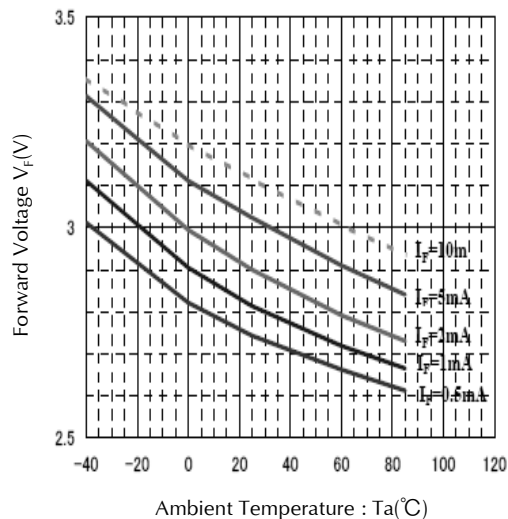



## Technical Data

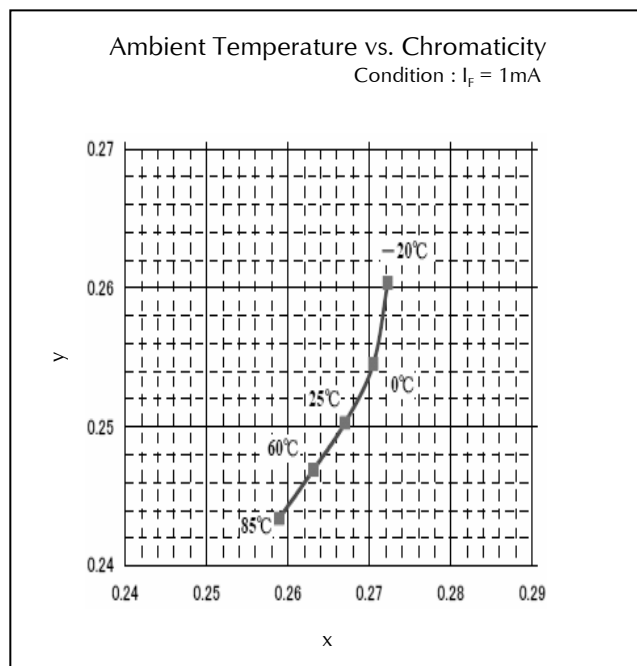
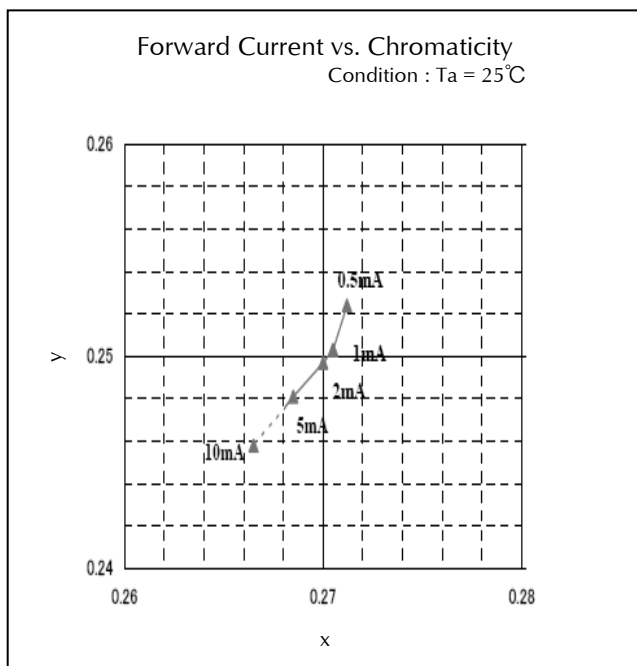
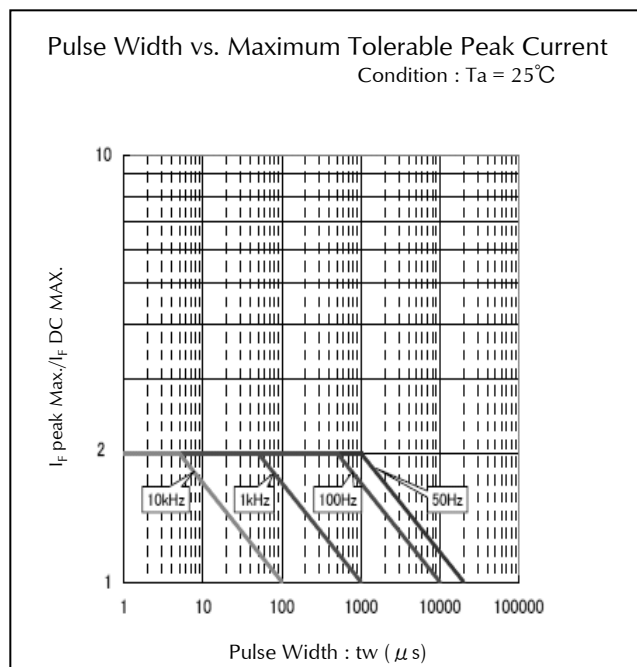
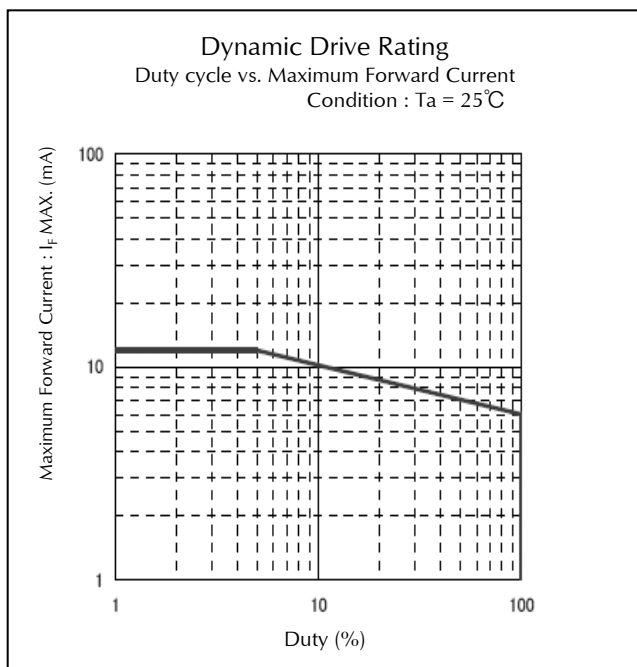

## Package Dimensions

(Unit: mm)

Weight: (0.95)mg

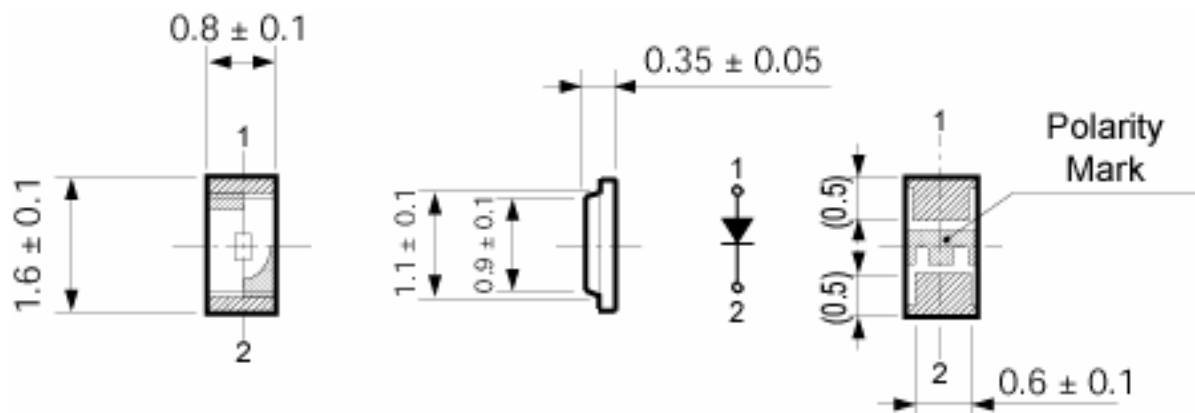

## Recommended Soldering Pattern

(Unit: mm)

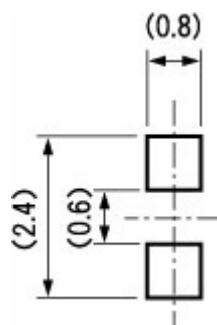

## Taping Specification

(Unit: mm)

Quantity: 4,000pcs/ reel (standard)

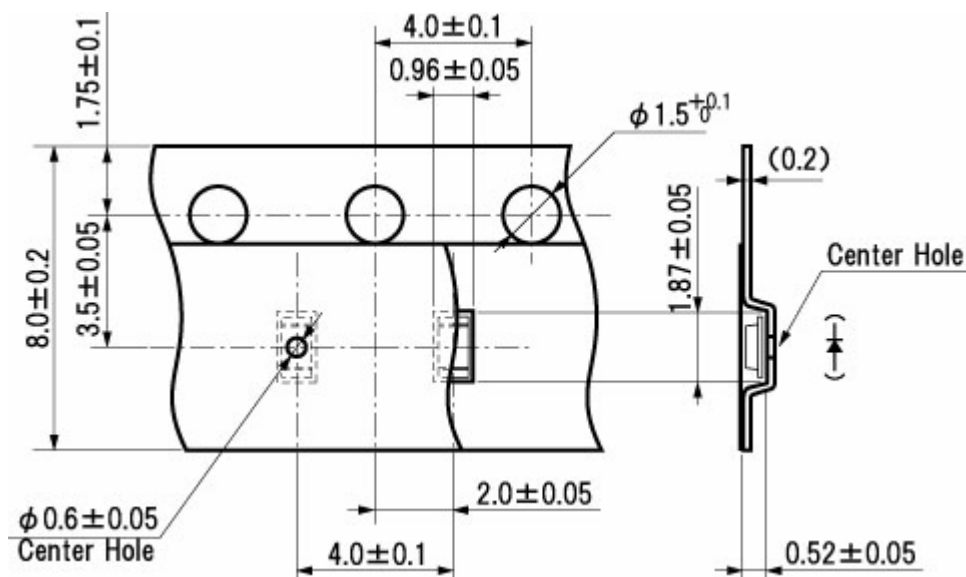

## Reflow Soldering Conditions

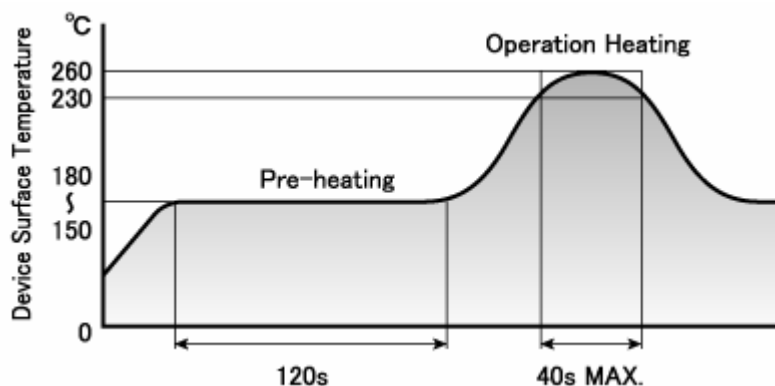

- 1) The above profile temperature gives the maximum temperature of the LED resin surface. Please set the temperature so as to avoid exceeding this range.
- 2) Total times of reflow soldering process shall be no more than 2 times. When the second reflow soldering process is performed, intervals between the first and second reflow should be short as possible (while allowing some time for the component to return to normal temperature after the first reflow) in order to prevent the LED from absorbing moisture.
- 3) Temperature fluctuation to the LED during the pre-heating process shall be minimized.

## Manual Soldering Conditions

Iron tip temp.	350 °C	(MAX.)
----------------	--------	--------

Soldering time and frequency	3 s	(MAX.)
	1 time	(MAX.)

## Handling

---

These types are designed chiefly for Cellular phone application, and are setting the thickness of the Product to 0.4mm or less thinly. To achieve the tin type of the product, making each material thin is aimed at. Because they are inferior to our general LEDs by an external stress, please use these product types after paying attention to the following.

- 1) Please set the mounting load to Max. 2N.
- 2) Please do not increase more quantity of the soldering paste than necessary quantity  
(The thickness of stencil Mask : about 100-120 $\mu$ ), because the terminal area of the product is small.
- 3) Please avoid the collision of the mounting board etc. after LEDs were mounted on the substrate.
- 4) When warp of substrate is large after these were mounted on FPC etc, please use these product types after affirming these is no problem.
- 5) Please use these product types after affirming there is no problem about the mounting position etc. of product from substrate edge, when mounting them on multi-layer and multi-piece PCBs.

## Reliability Testing Result

Reliability Testing Result	Applicable Standard	Testing Conditions	Duration	Failure
Room Temp. Operating Life	EIAJ ED-4701/100(101)	Ta = 25°C, If = Maximum Rated Current	1,000 h	0/25
Resistance to Soldering Heat	EIAJ ED-4701/300(301)	Pre-heating : 150~180°C 120s Max. Operation Heating : 230°C 40s Max. Peak Temperature : 260°C	Twice	0/25
Temperature Cycling	EIAJ ED-4701/100(105)	Minimum Rated Storage Temperature(30min) ~Normal Temperature(15min) ~Maximum Rated Storage Temperature(30min) ~Normal Temperature(15min)	5 cycles	0/25
Wet High Temp. Storage Life	EIAJ ED-4701/100(103)	Ta = 60±2°C, RH = 90±5%	1,000 h	0/25
High Temp. Storage Life	EIAJ ED-4701/200(201)	Ta = Maximum Rated Storage Temperature	1,000 h	0/25
Low Temp. Storage Life	EIAJ ED-4701/200(202)	Ta = Minimum Rated Storage Temperature	1,000 h	0/25
Vibration, Variable Frequency	EIAJ ED-4701/400(403)	98.1 m/s <sup>2</sup> (10G), 100 ~ 2KHz sweep for 20min., XYZ each direction	2 h	0/10

## Failure Criteria

Items	Symbols	Conditions	Failure criteria
Luminous Intensity	Iv	If Value of each product Luminous Intensity	Testing Min. Value < Spec. Min. Value x 0.5
Forward Voltage	V <sub>F</sub>	If Value of each product Forward Voltage	Testing Max. Value ≥ Spec. Max. Value x 1.2
Reverse Current	I <sub>R</sub>	V <sub>R</sub> = Maximum Rated Reverse Voltage V	Testing Max. Value ≥ Spec. Max. Value x 2.5
Cosmetic Appearance	-	-	Occurrence of notable decoloration, deformation and cracking

## Special Notice to Customers Using the Products and Technical Information Shown in This Data Sheet

- 1) The technical information shown in the data sheets are limited to the typical characteristics and circuit examples of the referenced products. It does not constitute the warranting of industrial property nor the granting of any license.
- 2) For the purpose of product improvement, the specifications, characteristics and technical data described in the data sheets are subject to change without prior notice. Therefore it is recommended that the most updated specifications be used in your design.
- 3) When using the products described in the data sheets, please adhere to the maximum ratings for operating voltage, heat dissipation characteristics, and other precautions for use. We are not responsible for any damage which may occur if these specifications are exceeded.
- 4) The products that have been described to this catalog are manufactured so that they will be used for the electrical instrument of the benchmark (OA equipment, telecommunications equipment, AV machine, home appliance and measuring instrument).  
The application of aircrafts, space borne application, transportation equipment, medical equipment and nuclear power control equipment, etc. needs a high reliability and safety, and the breakdown and the wrong operation might influence the life or the human body. Please consult us beforehand if you plan to use our product for the usages of aircrafts, space borne application, transportation equipment, medical equipment and nuclear power control equipment, etc. except OA equipment, telecommunications equipment, AV machine, home appliance and measuring instrument.
- 5) In order to export the products or technologies described in this data sheet which are under the "Foreign Exchange and Foreign Trade Control Law," it is necessary to first obtain an export permit from the Japanese government.
- 6) No part of this data sheet may be reprinted or reproduced without prior written permission from Stanley Electric Co., Ltd.
- 7) The most updated edition of this data sheet can be obtained from the address below:  
<http://www.stanley-components.com>