

PROTECTION PRODUCTS - Z-Pak™

Description

μ Clamp[®] TVS diodes are designed to protect sensitive electronics from damage or latch-up due to ESD. They are designed to replace 0201 size multilayer varistors (MLVs) in portable applications such as cell phones, notebook computers, and other portable electronics. They feature large cross-sectional area junctions for conducting high transient currents. These devices offer desirable characteristics for board level protection including fast response time, low operating and clamping voltage, and no device degradation.

μ Clamp[®]0551Y features extremely good ESD protection characteristics highlighted by low typical dynamic resistance of 0.37 Ohms, low peak ESD clamping voltage, and high ESD withstand voltage (+/-20kV contact per IEC 61000-4-2). Low typical capacitance (6.9pF at VR=0V) minimizes loading on sensitive circuits. Each device will protect one data or power line operating at 5 Volts.

μ Clamp0551Y is in a 2-pin SLP0603P2X3E package measuring 0.6 x 0.3 mm with a nominal height of 0.25mm. Leads are finished with lead-free NiAu. The small package gives the designer the flexibility to protect single lines in applications where arrays are not practical. The combination of small size and high ESD surge capability makes them ideal for use in portable applications such as cellular phones, digital cameras, and tablet PC's.

Features

- ◆ High ESD withstand Voltage: +/-20kV (Contact/Air) per **IEC 61000-4-2**
- ◆ Able to withstand over 1000 ESD strikes per IEC 61000-4-2 Level 4
- ◆ Ultra-small **0201 package**
- ◆ Protects one data or power line
- ◆ Low reverse current: <3nA typical (VR=5V)
- ◆ Working voltage: +/- 5V
- ◆ Low capacitance: 6.9pF typical
- ◆ Extremely low dynamic resistance: 0.37 Ohms (Typ)
- ◆ Solid-state silicon-avalanche technology

Mechanical Characteristics

- ◆ SLP0603P2X3E Package
- ◆ Pb-Free, Halogen Free, RoHS/WEEE Compliant
- ◆ Nominal Dimensions: 0.6 x 0.3 x 0.25 mm
- ◆ Lead Finish: NiAu
- ◆ Marking: Marking Code
- ◆ Packaging: Tape and Reel

Applications

- ◆ Cellular Handsets & Accessories
- ◆ Keypads, Side Keys, Audio Ports
- ◆ Portable Instrumentation
- ◆ Digital Lines
- ◆ Tablet PC

Nominal Dimensions

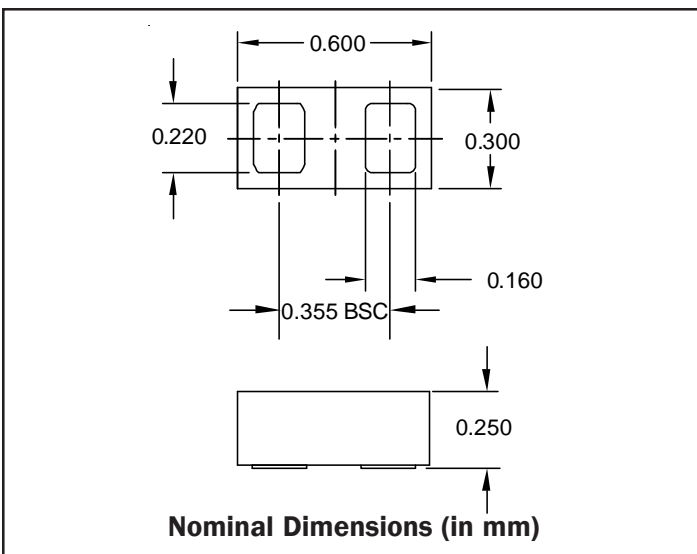

Schematic

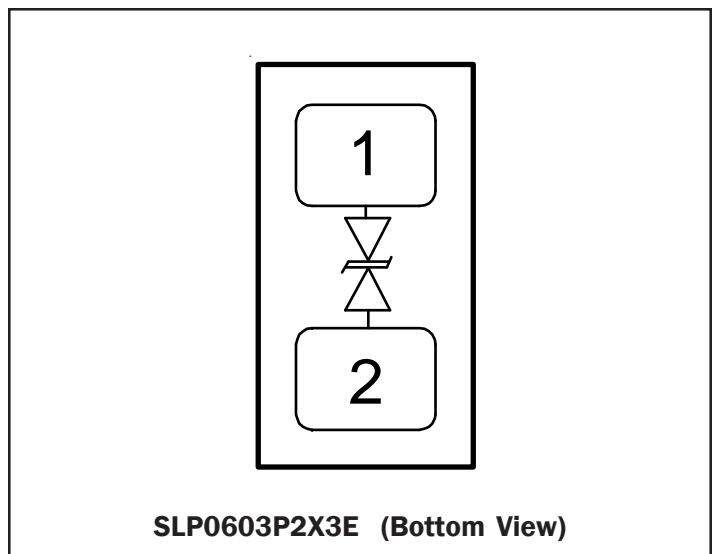

PROTECTION PRODUCTS
Absolute Maximum Rating

Rating	Symbol	Value	Units
Peak Pulse Power (tp = 8/20μs)	P_{pk}	30	Watts
Maximum Peak Pulse Current (tp = 8/20μs)	I_{pp}	2.5	Amps
ESD per IEC 61000-4-2 (Air) ¹ ESD per IEC 61000-4-2 (Contact) ¹	V_{ESD}	+/- 20 +/- 20	kV
Operating Temperature	T_J	-40 to +125	°C
Storage Temperature	T_{STG}	-55 to +150	°C

Electrical Characteristics (T=25°C)

Parameter	Symbol	Conditions	Minimum	Typical	Maximum	Units
Reverse Stand-Off Voltage	V_{RWM}	Pin 1 to 2 or 2 to 1			5	V
Reverse Breakdown Voltage	V_{BR}	$I_t = 1mA$ Pin 1 to 2 or 2 to 1	6	8	9.5	V
Reverse Leakage Current	I_R	$V_{RWM} = 5V, T=25°C$ Pin 1 to 2 or 2 to 1		3	50	nA
Clamping Voltage	V_C	$I_{pp} = 1A, tp = 8/20μs$ Pin 1 to 2 or 2 to 1			11	V
Clamping Voltage	V_C	$I_{pp} = 2.5A, tp = 8/20μs$ Pin 1 to 2 or 2 to 1			12	V
ESD Clamping Voltage ²	V_C	IPP = 4A, t _{lp} = 0.2/100ns		9.5		V
ESD Clamping Voltage ²	V_C	IPP = 16A, t _{lp} = 0.2/100ns		14		V
ESD Clamping Voltage ²	V_C	IPP = 30A, t _{lp} = 0.2/100ns		18.5		V
ESD Peak Clamping Voltage ²	$V_C \text{ max}$	+/-8kV Contact per IEC 6100-4-2		+/-35		V
Dynamic Resistance ^{2, 3}	R_D	tp = 100ns		0.37		Ohms
Junction Capacitance	C_j	$V_R = 0V \text{ to } 5V, f = 1MHz$		6.9	9	pF

Notes

- 1)ESD gun return path connected to ESD ground reference plane.
- 2)Transmission Line Pulse Test (TLP) Settings: $t_p = 100ns$, $t_r = 0.2ns$, I_{TLP} and V_{TLP} averaging window: $t_1 = 70ns$ to $t_2 = 90ns$.
- 3) Dynamic resistance calculated from $I_{TLP} = 4A$ to $I_{TLP} = 16A$

PROTECTION PRODUCTS

Typical Characteristics

Non-Repetitive Peak Pulse Power vs. Pulse Time

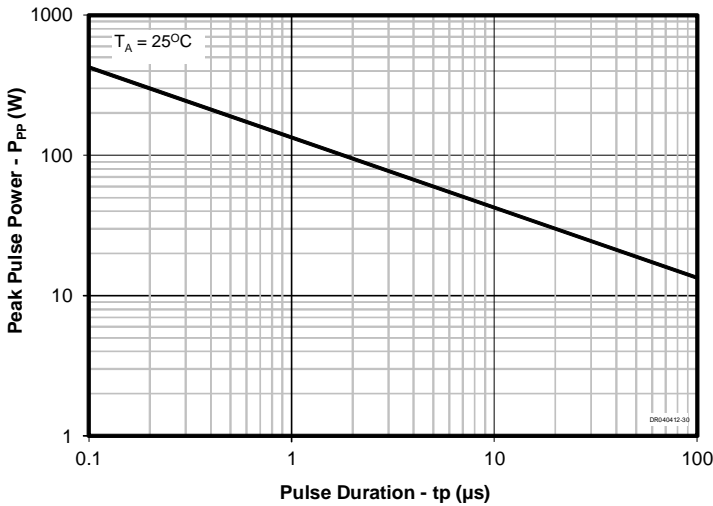

Clamping Voltage vs. Peak Pulse Current ($t_p=8/20\mu$ s)

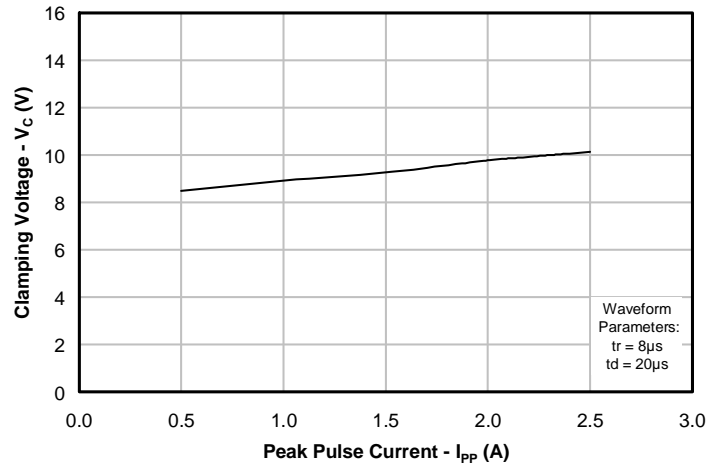

Junction Capacitance vs. Reverse Voltage

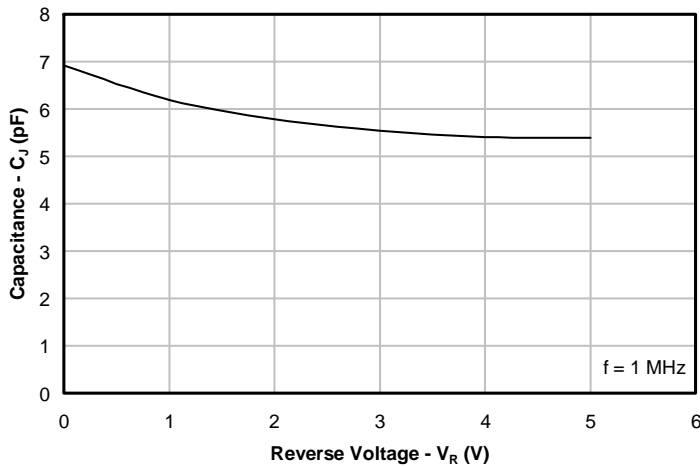

TLP Characteristic

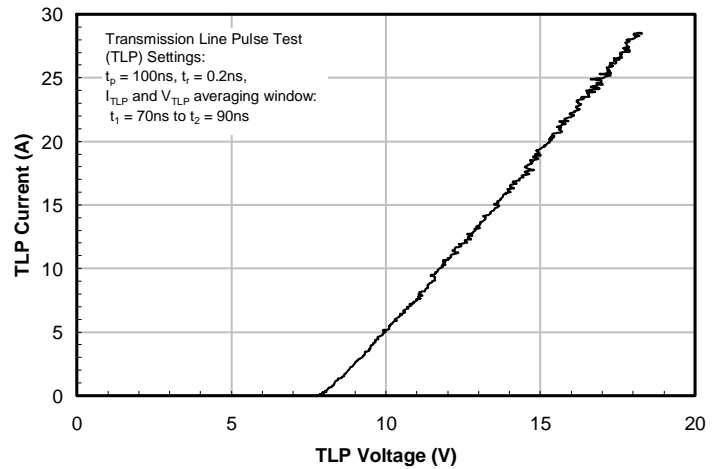

ESD Clamping (+8kV Contact per IEC 61000-4-2)

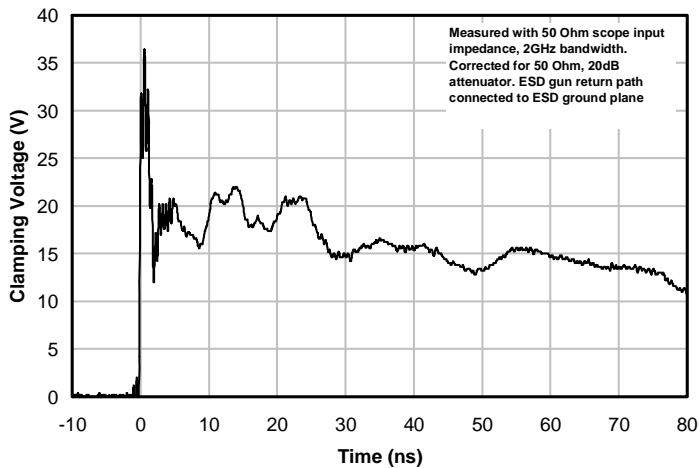

ESD Clamping (-8kV Contact per IEC 61000-4-2)

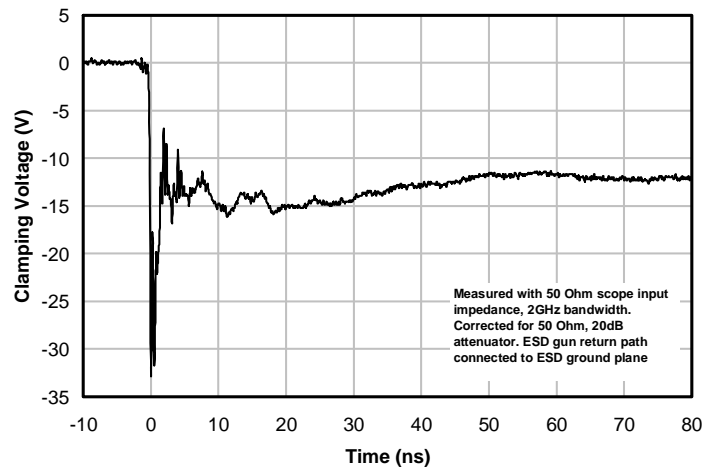

PROTECTION PRODUCTS

Typical Characteristics

Typical Insertion Loss S21

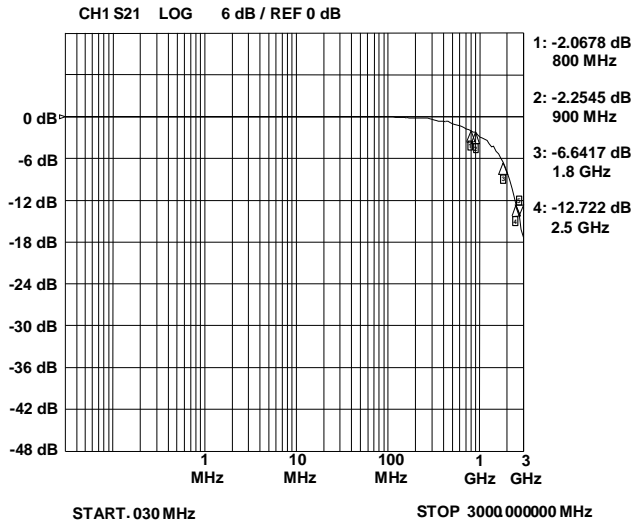

Applications Information

Assembly Guidelines

The small size of this device means that some care must be taken during the mounting process to insure reliable solder joint. The table below provides Semtech's recommended assembly guidelines for mounting this device. The figure at the right details Semtech's recommended aperture based on the below recommendations. Note that these are only recommendations and should serve only as a starting point for design since there are many factors that affect the assembly process. The exact manufacturing parameters will require some experimentation to get the desired solder application.

Assembly Parameter	Recommendation
Solder Stencil Design	Laser cut, Electro-polished
Aperture shape	Rectangular with rounded corners
Solder Stencil Thickness	0.100 mm (0.004")
Solder Paste Type	Type 4 size sphere or smaller
Solder Reflow Profile	Per JEDEC J-STD-020
PCB Solder Pad Design	Non-Solder mask defined
PCB Pad Finish	OSP OR NiAu

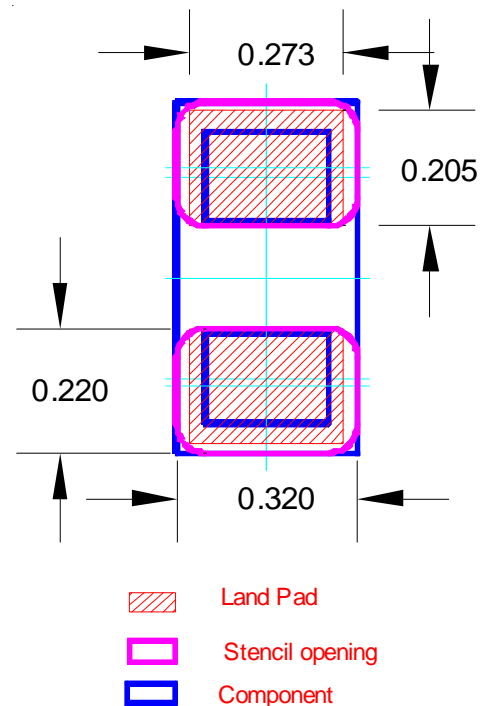

Recommended Mounting Pattern

PROTECTION PRODUCTS

Outline Drawing - SLP0603P2X3E

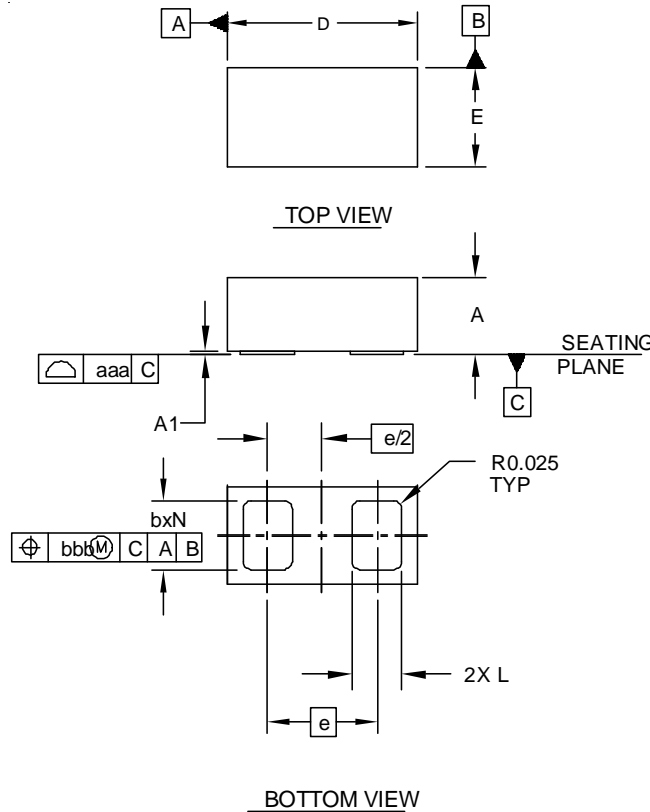

DIMENSIONS			
MILLIMETERS			
DIM	MIN	NOM	MAX
A	0.235	0.250	0.265
A1	0.000	0.010	0.050
b	0.200	0.220	0.240
D	0.580	0.600	0.620
E	0.280	0.300	0.320
e	0.355 BSC		
L	0.140	0.160	0.180
N	2		
aaa	0.08		
bbb	0.10		

- NOTES:
1. CONTROLLING DIMENSIONS ARE IN MILLIMETERS(ANGLES IN DEGREES).

Land Pattern - SLP0603P2X3E

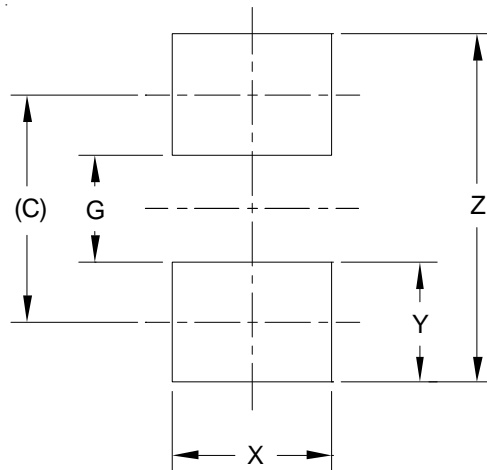

DIMENSIONS	
DIM	MILLIMETERS
C	(0.385)
G	0.181
X	0.273
Y	0.205
Z	0.590

- NOTES:
1. CONTROLLING DIMENSIONS ARE IN MILLIMETERS (ANGLES IN DEGREES).
 2. THIS LAND PATTERN IS FOR REFERENCE PURPOSES ONLY .
CONSULT YOUR MANUFACTURING GROUP TO ENSURE YOUR
COMPANY'S MANUFACTURING GUIDELINES ARE MET .

PROTECTION PRODUCTS

Marking Code

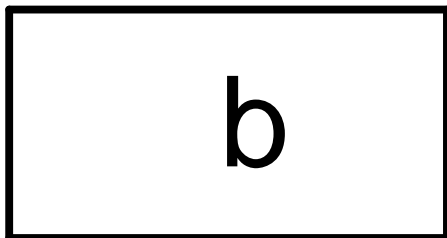

Ordering Information

Part Number	Qty per Reel	Pocket Pitch	Reel Size
uClamp0551Y.TFT	15,000	2mm	7 Inch

Note:
MicroClamp, uClamp and μ Clamp are trademarks of Semtech Corporation

Note:
Device is electrically symmetrical

Carrier Tape Specification

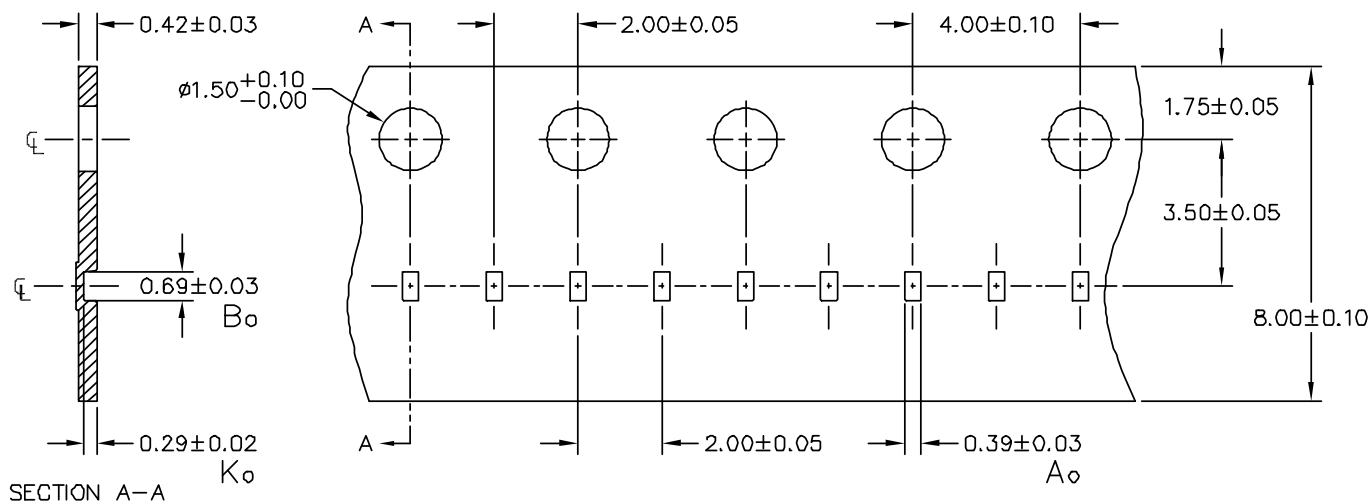

NOTES: ALL DIMENSIONS IN MILLIMETERS UNLESS OTHERWISE SPECIFIED.

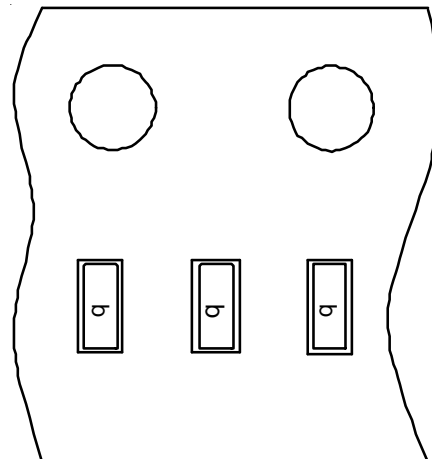

Device Orientation in Tape

Contact Information

Semtech Corporation
Protection Products Division
200 Flynn Rd., Camarillo, CA 93012
Phone: (805)498-2111 FAX (805)498-3804