

# NIF62514

## Self-protected FET, Temp and Current Limit, Voltage Clamp, ESD, SOT-223

HDPlus devices are an advanced series of power MOSFETs which utilize ON Semiconductor's latest MOSFET technology process to achieve the lowest possible on-resistance per silicon area while incorporating smart features. Integrated thermal and current limits work together to provide short circuit protection. The devices feature an integrated Drain-to-Gate Clamp that enables them to withstand high energy in the avalanche mode. The Clamp also provides additional safety margin against unexpected voltage transients. Electrostatic Discharge (ESD) protection is provided by an integrated Gate-to-Source Clamp.

### Features

- Current Limitation
- Thermal Shutdown with Automatic Restart
- Short Circuit Protection
- Low  $R_{DS(on)}$
- $I_{DSS}$  Specified at Elevated Temperature
- Avalanche Energy Specified
- Slew Rate Control for Low Noise Switching
- Overvoltage Clamped Protection
- This is a Pb-Free Device



ON Semiconductor®

<http://onsemi.com>

**6.0 AMPERES\***  
**40 VOLTS CLAMPED**  
 $R_{DS(on)} = 90 \text{ m}\Omega$

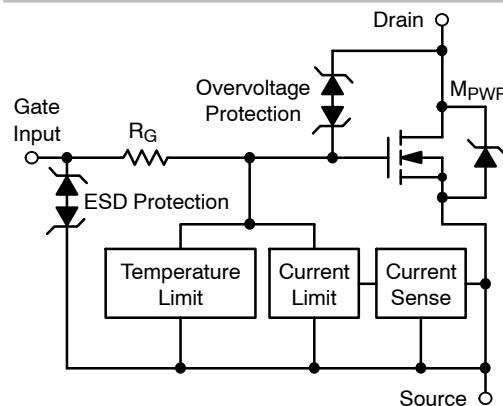

### MARKING DIAGRAM

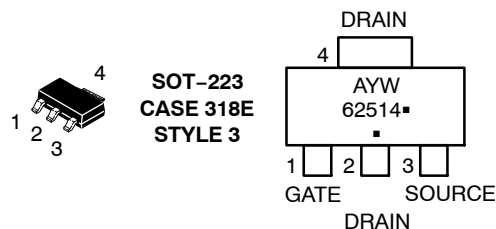

A = Assembly Location  
 Y = Year  
 W = Work Week  
 62514 = Specific Device Code  
 ■ = Pb-Free Package

(Note: Microdot may be in either location)

### ORDERING INFORMATION

Device	Package	Shipping†
NIF62514T1G	SOT-223 (Pb-Free)	1000/Tape & Reel
NIF62514T3G	SOT-223 (Pb-Free)	4000/Tape & Reel

†For information on tape and reel specifications, including part orientation and tape sizes, please refer to our Tape and Reel Packaging Specification Brochure, BRD8011/D.

\*Limited by the current limit circuit.

# NIF62514

## MOSFET MAXIMUM RATINGS ( $T_J = 25^\circ\text{C}$ unless otherwise noted)

Rating	Symbol	Value	Unit
Drain-to-Source Voltage Internally Clamped	$V_{DSS}$	40	Vdc
Drain-to-Gate Voltage Internally Clamped ( $R_{GS} = 1.0\text{ M}\Omega$ )	$V_{DGR}$	40	Vdc
Gate-to-Source Voltage	$V_{GS}$	$\pm 16$	Vdc
Drain Current - Continuous @ $T_A = 25^\circ\text{C}$ - Continuous @ $T_A = 100^\circ\text{C}$ - Pulsed ( $t_p \leq 10\ \mu\text{s}$ )	$I_D$ $I_{D1}$ $I_{DM}$	Internally Limited	
Total Power Dissipation @ $T_A = 25^\circ\text{C}$ (Note 1) @ $T_A = 25^\circ\text{C}$ (Note 2) @ $T_A = 25^\circ\text{C}$ (Note 3)	$P_D$	1.1 1.73 8.93	W
Thermal Resistance, Junction-to-Tab Junction-to-Ambient (Note 1) Junction-to-Ambient (Note 2)	$R_{\theta JT}$ $R_{\theta JA}$ $R_{\theta JA}$	14 114 72.3	$^\circ\text{C/W}$
Single Pulse Drain-to-Source Avalanche Energy ( $V_{DD} = 25\text{ Vdc}$ , $V_{GS} = 5.0\text{ Vdc}$ , $V_{DS} = 40\text{ Vdc}$ , $I_L = 2.8\text{ Apk}$ , $L = 80\text{ mH}$ , $R_G = 25\ \Omega$ )	$E_{AS}$	300	mJ
Operating and Storage Temperature Range	$T_J, T_{stg}$	-55 to 150	$^\circ\text{C}$

Stresses exceeding Maximum Ratings may damage the device. Maximum Ratings are stress ratings only. Functional operation above the Recommended Operating Conditions is not implied. Extended exposure to stresses above the Recommended Operating Conditions may affect device reliability.

1. Mounted onto min pad board.
2. Mounted onto 1" pad board.
3. Mounted onto large heatsink.

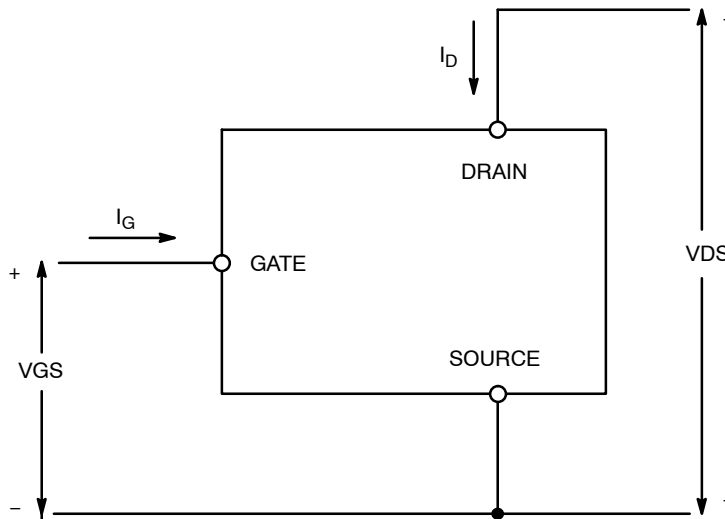

Figure 1. Voltage and Current Convention

# NIF62514

## MOSFET ELECTRICAL CHARACTERISTICS (T<sub>J</sub> = 25°C unless otherwise noted)

Characteristic	Symbol	Min	Typ	Max	Unit
----------------	--------	-----	-----	-----	------

### OFF CHARACTERISTICS

Drain-to-Source Clamped Breakdown Voltage (V <sub>GS</sub> = 0 Vdc, I <sub>D</sub> = 250 μAdc) (V <sub>GS</sub> = 0 Vdc, I <sub>D</sub> = 250 μAdc, T <sub>J</sub> = 150°C) (Note 4)	V <sub>(BR)DSS</sub>	42 42	46 45	50 50	Vdc
Zero Gate Voltage Drain Current (V <sub>DS</sub> = 32 Vdc, V <sub>GS</sub> = 0 Vdc) (V <sub>DS</sub> = 32 Vdc, V <sub>GS</sub> = 0 Vdc, T <sub>J</sub> = 150°C) (Note 4)	I <sub>DSS</sub>	– –	0.5 2.0	2.0 10	μAdc
Gate Input Current (V <sub>GS</sub> = 5.0 Vdc, V <sub>DS</sub> = 0 Vdc) (V <sub>GS</sub> = -5.0 Vdc, V <sub>DS</sub> = 0 Vdc)	I <sub>GSS</sub>	– –	50 550	100 1000	μAdc

### ON CHARACTERISTICS

Gate Threshold Voltage (V <sub>DS</sub> = V <sub>GS</sub> , I <sub>D</sub> = 150 μAdc) Threshold Temperature Coefficient (Negative)	V <sub>GS(th)</sub>	1.0 –	1.7 4.0	2.0 –	Vdc mV/°C
Static Drain-to-Source On-Resistance (Note 5) (V <sub>GS</sub> = 10 Vdc, I <sub>D</sub> = 1.4 Adc, T <sub>J</sub> @ 25°C) (V <sub>GS</sub> = 10 Vdc, I <sub>D</sub> = 1.4 Adc, T <sub>J</sub> @ 150°C) (Note 4)	R <sub>DS(on)</sub>	– –	90 165	100 190	mΩ
Static Drain-to-Source On-Resistance (Note 5) (V <sub>GS</sub> = 5.0 Vdc, I <sub>D</sub> = 1.4 Adc, T <sub>J</sub> @ 25°C) (V <sub>GS</sub> = 5.0 Vdc, I <sub>D</sub> = 1.4 Adc, T <sub>J</sub> @ 150°C) (Note 4)	R <sub>DS(on)</sub>	– –	105 185	120 210	mΩ
Source-Drain Forward On Voltage (I <sub>S</sub> = 7 A, V <sub>GS</sub> = 0 V)	V <sub>SD</sub>	–	1.05	–	V

### SWITCHING CHARACTERISTICS (Note 4)

Turn-on Delay Time R <sub>L</sub> = 4.7 Ω, V <sub>in</sub> = 0 to 10 V, V <sub>DD</sub> = 12 V	t <sub>d(on)</sub>	–	4.0	8.0	μs
Turn-on Rise Time R <sub>L</sub> = 4.7 Ω, V <sub>in</sub> = 0 to 10 V, V <sub>DD</sub> = 12 V	t <sub>rise</sub>	–	11	20	μs
Turn-off Delay Time R <sub>L</sub> = 4.7 Ω, V <sub>in</sub> = 10 to 0 V, V <sub>DD</sub> = 12 V	t <sub>d(off)</sub>	–	32	50	μs
Turn-off Fall Time R <sub>L</sub> = 4.7 Ω, V <sub>in</sub> = 10 to 0 V, V <sub>DD</sub> = 12 V	t <sub>fall</sub>	–	27	50	μs
Slew-Rate On R <sub>L</sub> = 4.7 Ω, V <sub>in</sub> = 0 to 10 V, V <sub>DD</sub> = 12 V	-dV <sub>DS</sub> /dt <sub>on</sub>	–	1.5	2.5	μs
Slew-Rate Off R <sub>L</sub> = 4.7 Ω, V <sub>in</sub> = 10 to 0 V, V <sub>DD</sub> = 12 V	dV <sub>DS</sub> /dt <sub>off</sub>	–	0.6	1.0	μs

### SELF PROTECTION CHARACTERISTICS (T<sub>J</sub> = 25°C unless otherwise noted)

Current Limit (V <sub>GS</sub> = 5.0 Vdc) (V <sub>GS</sub> = 5.0 Vdc, T <sub>J</sub> = 150°C) (Note 4)	I <sub>LIM</sub>	6.0 3.0	9.0 5.0	11 8.0	Adc
Current Limit (V <sub>GS</sub> = 10 Vdc) (V <sub>GS</sub> = 10 Vdc, T <sub>J</sub> = 150°C) (Note 4)	I <sub>LIM</sub>	7.0 4.0	10.5 7.5	13 10	Adc
Temperature Limit (Turn-off) (Note 4)	T <sub>LIM(off)</sub>	150	175	200	°C
Temperature Hysteresis (Note 4)	ΔT <sub>LIM(on)</sub>	–	15	–	°C
Temperature Limit (Turn-off) (Note 4)	T <sub>LIM(off)</sub>	150	165	185	°C
Temperature Hysteresis (Note 4)	ΔT <sub>LIM(on)</sub>	–	15	–	°C

### ESD ELECTRICAL CHARACTERISTICS (T<sub>J</sub> = 25°C unless otherwise noted)

Electro-Static Discharge Capability	Human Body Model (HBM)	ESD	4000	–	–	V
Electro-Static Discharge Capability	Machine Model (MM)	ESD	400	–	–	V

4. Not subject to production testing.  
5. Pulse Test: Pulse Width = 300 μs, Duty Cycle = 2%.

TYPICAL ELECTRICAL CHARACTERISTICS

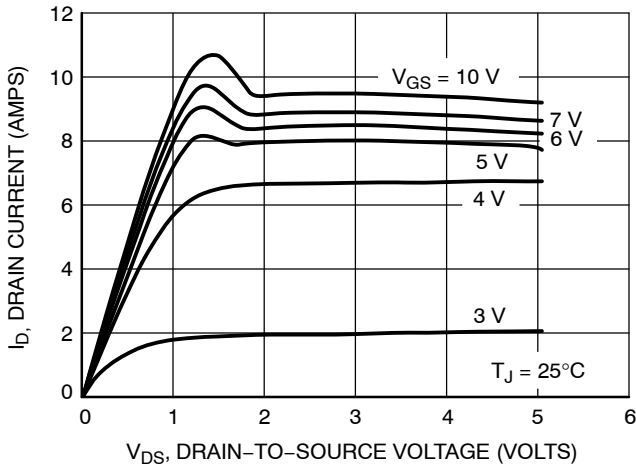

Figure 1. Output Characteristics

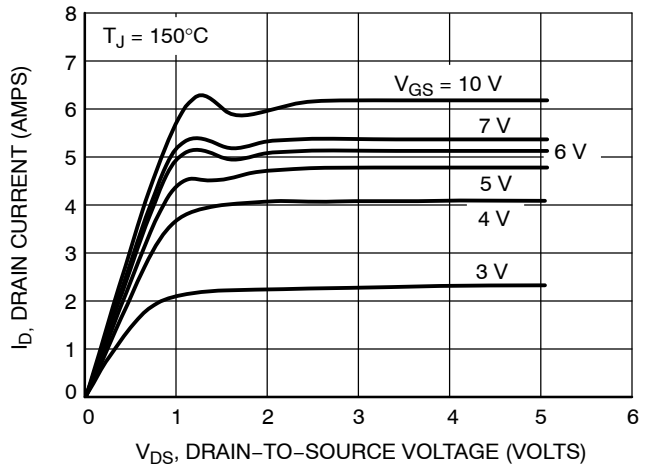

Figure 2. Output Characteristics

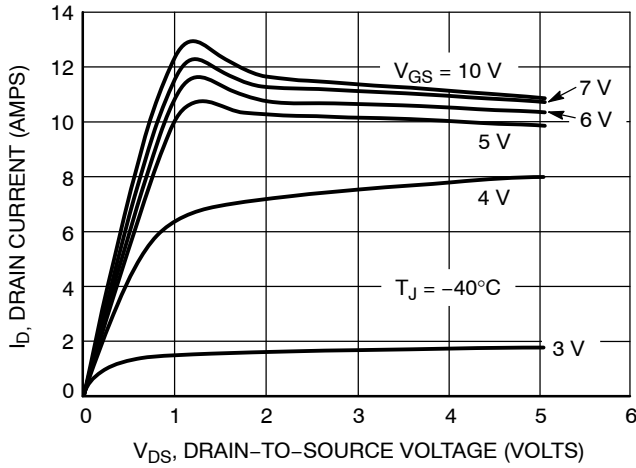

Figure 3. Output Characteristics

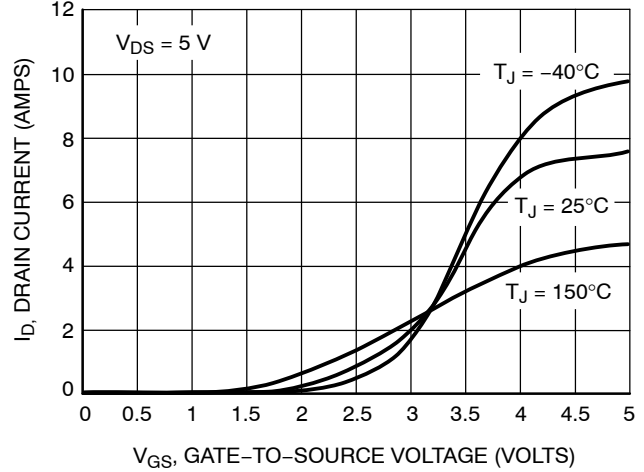

Figure 4. Transfer Characteristics

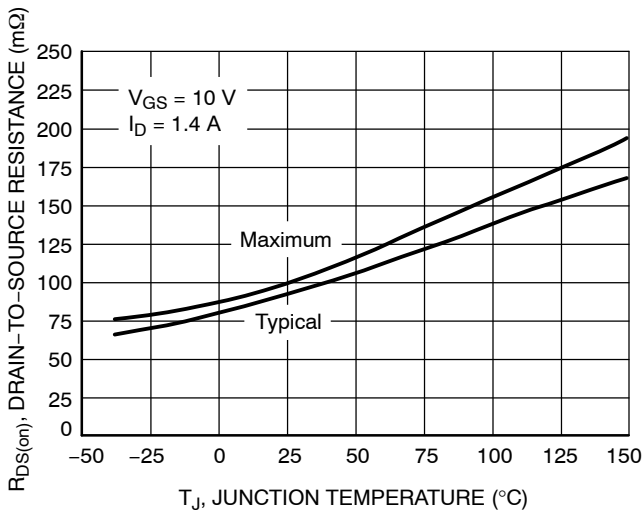

Figure 5. Drain-to-Source Resistance versus Junction Temperature

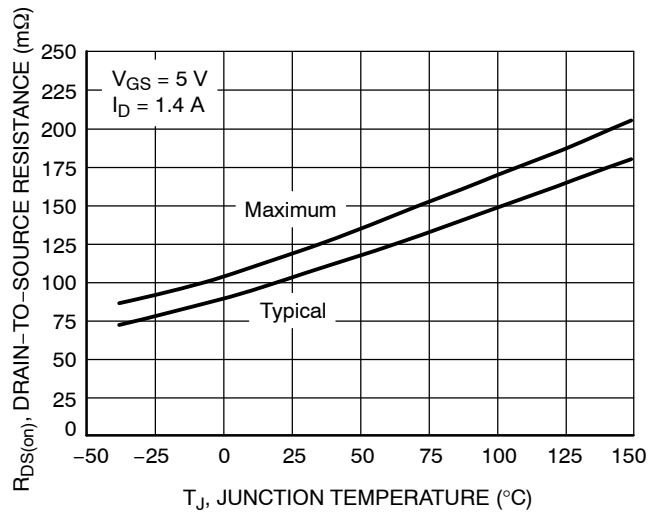

Figure 6. Drain-to-Source Resistance versus Junction Temperature

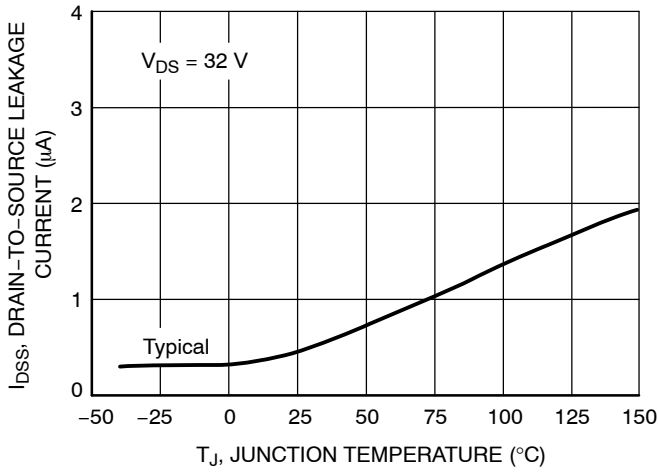

Figure 7. Drain-to-Source Resistance versus Junction Temperature

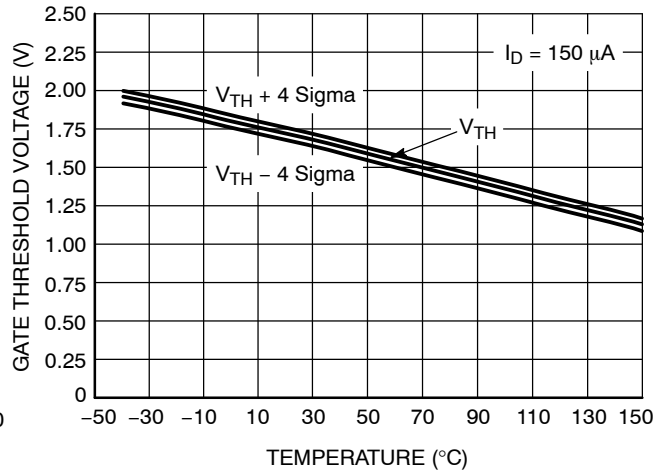

Figure 8. Gate Threshold Voltage versus Temperature

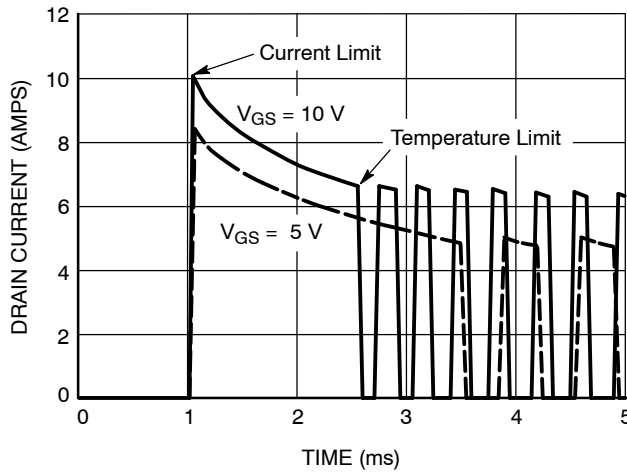

Figure 9. Short-circuit Response

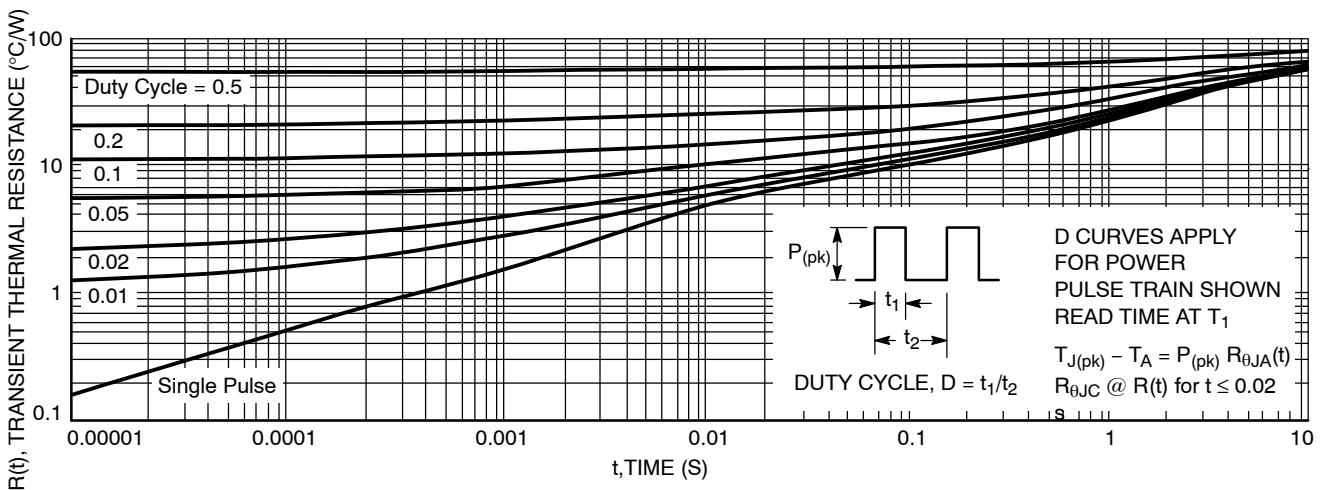

Figure 10. Transient Thermal Resistance (Non-normalized Junction-to-Ambient mounted on minimum pad area)

# MECHANICAL CASE OUTLINE

## PACKAGE DIMENSIONS

ON Semiconductor®



SCALE 1:1

SOT-223 (TO-261)  
CASE 318E-04  
ISSUE R

DATE 02 OCT 2018

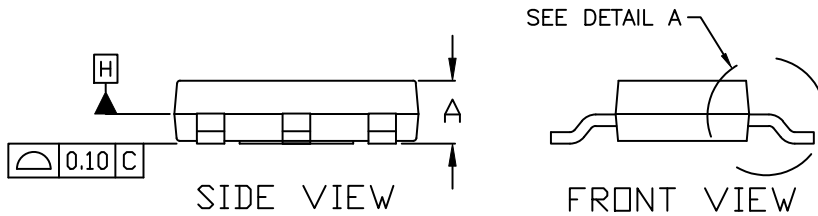

NOTES:

1. DIMENSIONING AND TOLERANCING PER ASME Y14.5M, 1994.
2. CONTROLLING DIMENSION: MILLIMETERS
3. DIMENSIONS D & E DO NOT INCLUDE MOLD FLASH, PROTRUSIONS OR GATE BURRS. MOLD FLASH, PROTRUSIONS OR GATE BURRS SHALL NOT EXCEED 0.200MM PER SIDE.
4. DATUMS A AND B ARE DETERMINED AT DATUM H.
5. A1 IS DEFINED AS THE VERTICAL DISTANCE FROM THE SEATING PLANE TO THE LOWEST POINT OF THE PACKAGE BODY.
6. POSITIONAL TOLERANCE APPLIES TO DIMENSIONS b AND b1.

MILLIMETERS			
DIM	MIN.	NOM.	MAX.
A	1.50	1.63	1.75
A1	0.02	0.06	0.10
b	0.60	0.75	0.89
b1	2.90	3.06	3.20
c	0.24	0.29	0.35
D	6.30	6.50	6.70
E	3.30	3.50	3.70
e	2.30 BSC		
L	0.20	---	---
L1	1.50	1.75	2.00
He	6.70	7.00	7.30
$\theta$	0°	---	10°



DOCUMENT NUMBER:	98ASB42680B	Electronic versions are uncontrolled except when accessed directly from the Document Repository. Printed versions are uncontrolled except when stamped "CONTROLLED COPY" in red.
DESCRIPTION:	SOT-223 (TO-261)	PAGE 1 OF 2

ON Semiconductor and are trademarks of Semiconductor Components Industries, LLC dba ON Semiconductor or its subsidiaries in the United States and/or other countries. ON Semiconductor reserves the right to make changes without further notice to any products herein. ON Semiconductor makes no warranty, representation or guarantee regarding the suitability of its products for any particular purpose, nor does ON Semiconductor assume any liability arising out of the application or use of any product or circuit, and specifically disclaims any and all liability, including without limitation special, consequential or incidental damages. ON Semiconductor does not convey any license under its patent rights nor the rights of others.

**SOT-223 (TO-261)**  
**CASE 318E-04**  
**ISSUE R**

DATE 02 OCT 2018

- |  |   |   |   |   |
|--|---|---|---|---|
| <b>STYLE 1:</b><br>PIN 1. BASE<br>2. COLLECTOR<br>3. EMITTER<br>4. COLLECTOR | <b>STYLE 2:</b><br>PIN 1. ANODE<br>2. CATHODE<br>3. NC<br>4. CATHODE        | <b>STYLE 3:</b><br>PIN 1. GATE<br>2. DRAIN<br>3. SOURCE<br>4. DRAIN           | <b>STYLE 4:</b><br>PIN 1. SOURCE<br>2. DRAIN<br>3. GATE<br>4. DRAIN   | <b>STYLE 5:</b><br>PIN 1. DRAIN<br>2. GATE<br>3. SOURCE<br>4. GATE    |
| <b>STYLE 6:</b><br>PIN 1. RETURN<br>2. INPUT<br>3. OUTPUT<br>4. INPUT        | <b>STYLE 7:</b><br>PIN 1. ANODE 1<br>2. CATHODE<br>3. ANODE 2<br>4. CATHODE | <b>STYLE 8:</b><br>CANCELLED  | <b>STYLE 9:</b><br>PIN 1. INPUT<br>2. GROUND<br>3. LOGIC<br>4. GROUND | <b>STYLE 10:</b><br>PIN 1. CATHODE<br>2. ANODE<br>3. GATE<br>4. ANODE |
| <b>STYLE 11:</b><br>PIN 1. MT 1<br>2. MT 2<br>3. GATE<br>4. MT 2             | <b>STYLE 12:</b><br>PIN 1. INPUT<br>2. OUTPUT<br>3. NC<br>4. OUTPUT         | <b>STYLE 13:</b><br>PIN 1. GATE<br>2. COLLECTOR<br>3. EMITTER<br>4. COLLECTOR |   |   |

**GENERIC  
 MARKING DIAGRAM\***



- A = Assembly Location
- Y = Year
- W = Work Week
- XXXXX = Specific Device Code
- = Pb-Free Package

(Note: Microdot may be in either location)

\*This information is generic. Please refer to device data sheet for actual part marking. Pb-Free indicator, "G" or microdot "▪", may or may not be present. Some products may not follow the Generic Marking.

<b>DOCUMENT NUMBER:</b>	<b>98ASB42680B</b>	Electronic versions are uncontrolled except when accessed directly from the Document Repository. Printed versions are uncontrolled except when stamped "CONTROLLED COPY" in red.
<b>DESCRIPTION:</b>	<b>SOT-223 (TO-261)</b>	<b>PAGE 2 OF 2</b>

ON Semiconductor and  are trademarks of Semiconductor Components Industries, LLC dba ON Semiconductor or its subsidiaries in the United States and/or other countries. ON Semiconductor reserves the right to make changes without further notice to any products herein. ON Semiconductor makes no warranty, representation or guarantee regarding the suitability of its products for any particular purpose, nor does ON Semiconductor assume any liability arising out of the application or use of any product or circuit, and specifically disclaims any and all liability, including without limitation special, consequential or incidental damages. ON Semiconductor does not convey any license under its patent rights nor the rights of others.

ON Semiconductor and  are trademarks of Semiconductor Components Industries, LLC dba ON Semiconductor or its subsidiaries in the United States and/or other countries. ON Semiconductor owns the rights to a number of patents, trademarks, copyrights, trade secrets, and other intellectual property. A listing of ON Semiconductor's product/patent coverage may be accessed at [www.onsemi.com/site/pdf/Patent-Marking.pdf](http://www.onsemi.com/site/pdf/Patent-Marking.pdf). ON Semiconductor reserves the right to make changes without further notice to any products herein. ON Semiconductor makes no warranty, representation or guarantee regarding the suitability of its products for any particular purpose, nor does ON Semiconductor assume any liability arising out of the application or use of any product or circuit, and specifically disclaims any and all liability, including without limitation special, consequential or incidental damages. Buyer is responsible for its products and applications using ON Semiconductor products, including compliance with all laws, regulations and safety requirements or standards, regardless of any support or applications information provided by ON Semiconductor. "Typical" parameters which may be provided in ON Semiconductor data sheets and/or specifications can and do vary in different applications and actual performance may vary over time. All operating parameters, including "Typicals" must be validated for each customer application by customer's technical experts. ON Semiconductor does not convey any license under its patent rights nor the rights of others. ON Semiconductor products are not designed, intended, or authorized for use as a critical component in life support systems or any FDA Class 3 medical devices or medical devices with a same or similar classification in a foreign jurisdiction or any devices intended for implantation in the human body. Should Buyer purchase or use ON Semiconductor products for any such unintended or unauthorized application, Buyer shall indemnify and hold ON Semiconductor and its officers, employees, subsidiaries, affiliates, and distributors harmless against all claims, costs, damages, and expenses, and reasonable attorney fees arising out of, directly or indirectly, any claim of personal injury or death associated with such unintended or unauthorized use, even if such claim alleges that ON Semiconductor was negligent regarding the design or manufacture of the part. ON Semiconductor is an Equal Opportunity/Affirmative Action Employer. This literature is subject to all applicable copyright laws and is not for resale in any manner.

## PUBLICATION ORDERING INFORMATION

### LITERATURE FULFILLMENT:

Email Requests to: [orderlit@onsemi.com](mailto:orderlit@onsemi.com)

ON Semiconductor Website: [www.onsemi.com](http://www.onsemi.com)

### TECHNICAL SUPPORT

North American Technical Support:  
Voice Mail: 1 800-282-9855 Toll Free USA/Canada  
Phone: 011 421 33 790 2910

### Europe, Middle East and Africa Technical Support:

Phone: 00421 33 790 2910

For additional information, please contact your local Sales Representative